

Precision
Planting®

PRECISION TECHNOLOGY INSTITUTE

2021 RESEARCH SUMMARY
PONTIAC, IL

2021 PTI Farm Research Summary

Table of Contents:

Year in Review	5
Top 10 Return on Investment Performers	6
Corn Summary of 2021 FurrowJet® Applications	96
Corn Summary of 2021 Conceal® Applications	132
Soybeans Table of Contents	162
Soybeans Summary of 2021 FurrowJet® & Conceal® Application	244
Wrap Up	249
2021 in Review	188-190
Acknowledgments and Legal Statement	191

Corn Planting Principles:

Planting Date	7	Nachurs® Impulse FurrowJet®	74-76
Starter Fertilizer Response by Date	8-9	Nachurs® Start2Finish	77
vSet® Planter Singulation	10	Pivot Bio PROVEN® Nitrogen Mgt.	78
Planting Depth	11-13	Pivot Bio PROVEN® FurrowJet®	79
Keeton® Seed Firmer	14	Aqua-Yield® NanoCS™ FurrowJet®	80-81
STP Opening Disc	15-16	AGROTECH NutriCharge®	82
Reveal® Residue Management	17-18	10-34-0 FurrowJet®	83
CleanSweep® Residue Management	19-20	Phosphorus Placement	84
Seed Trench Residue Management	21-22	QLF® L-CBF 7-21-3 MKP FurrowJet®	85
Multi-Year Day of Emergence	23	Stoller®USA FurrowJet®	86-87
2021 Crop Year Day of Emergence	24-25	Loveland Products RiseR® FurrowJet®	88
Closing Wheel System Emergence Timing	26-31	Ethos™ XB In-Furrow	89
High Speed Planting	32	Capture® LFR® In-Furrow	90
SeedTube Planting	33	Xyway™ LFR® FurrowJet®	91-94
Closing Wheel System	34-36	FurrowJet® Side-Wall	95
Downforce Management	37-39	Calcium Products SO4™	97
Planter "All-Wrong"	40	Continuous Corn Cover Crop	98
Water Management	41-45	Corn after Soybean Cover Crop	99
Tile Drainage	46-47	At-Plant Conceal® vs. Weed-N-Feed	106
Tile Irrigation Study	48-49	Single vs. Dual Band Conceal® Nitrogen	107
Multi-Genetic Planting	62-63	Conceal® Nitrogen Rate/Placement	108-111
Force® 6.5G vDrive® Insecticide	64	QLF BOOST™ Nitrogen Inclusion Study	112-113
Fendt® Momentum®	65	Dribble vs Conceal® Nitrogen	114-115
30" vs 20" Row Corn	100-102	Nitrogen Sealer	116
20" Row Corn Seeding Rate	103	Sidedress Placement	117-121
30" Row Corn Seeding Rate	104	Conceal® K-Fuse® Potassium	122
20" Solar Corridor	105	Marco Nitro "K"	123
Leaf Orientation	133	Nitrogen, Sulfur, Boron Conceal®	124-125
Corn Strip Planting	134-141	Boron Rate	126
		Nitrogen to Sulfur Ratio	127-129
		Conceal® Nitrogen Mgt in Cover Crop	130-131

Corn Fertility & Pest Management:

Marco QuickGrow™ LTE FurrowJet®	70
The Andersons® Corn Nutrition	71-72
AgroLiquid Starter Fertilizer FurrowJet®	73

Corn Fertility & Pest Management:

Stoller®USA V2 Foliar Application	142-143
Stoller®USA R1 Foliar Application	144-145
Veltyma™ Foliar Fungicide	146
TopGuard™ Foliar Fungicide	147
Miravis Neo™ Foliar Fungicide	148
Ground vs. UAV Foliar Application	149-150
Source™ Foliar Application	151
QLF L-CBF Amino 15-0-1 Foliar	152

Corn Harvest:

Chopping Corn Head	153
SCiO™ Pocket Molecular Sensor	154-155
Pre-Harvest Yield Estimation	161

Corn Tillage:

Broadcast vs Banding	66-67
Broadcast vs Banding Rate Efficiency	68-69
Corn Tillage	156-157
Finish Line™ Sweep	158-159
Strip-Till Freshener	160

Corn Intensive Management:

High Management	50-54
High Management Nachurs®	55-56
High Management Seeding Rate	57-58
High Management Ocean Blue Ag	59-60
High Management NETAFIM™ Irrigation	61

Soybean Planting Principles:

Planting Date	163
Starter Fertilizer Response by Date	164-165
Multi-Year Early Plant Date	166
Reveal™ Residue Management	167-168
CleanSweep® Residue Management	169-170
Downforce Management	171-173
Keeton® Seed Firmer	174
FurrowJet® Side-Wall	175
Singulation	176
Closing Wheels	177-179
FurrowForce® Auto vs Manual Control	180
Frost	192-195

STP Opening Discs	196-197
Strip Planting	198-205
Row Width & Seeding Rate	206-208
Early Planted Seeding Rate	209-210
High Speed	211
Air Seeder	212-213
Rolling	214-215
Planting Depth	248

Soybean Fertility & Pest Management:

Calcium Products 98G™	191
Cover Crop Study	216-217
Broadcast vs Banding	218-219
Broadcast vs Banding Rate Efficiency	220-221
Marco Quick Grow LTE FurrowJet®	222
Marco BioMarc FurrowJet®	223
Nachurs® Start2Finish	224
AgroLiquid® Starter Fertilizer	225
Stoller®USA FurrowJet®	226-227
QLF L-CBF Amino 15-0-1 Foliar	228
QLF L-CBF 5-5-5-1S Study	229
Stoller®USA V2 Foliar Application	233-234
Stoller®USA R3 Foliar Application	235-236
Revytek™ Foliar Fungicide	237
Miravis Neo™ Foliar Fungicide	238
Calcium Products SO4™	239
Marco Fertilizer Conceal® 14-12-4-6s	240
Nachurs® Conceal® K-Fuse® Potassium	241
L-CBF 7-21-3 MKP FurrowJet®	242
L-CBF Boost 4-0-3-2S Conceal®	243

Soybean Tillage:

Soybean Tillage	245-247
-----------------	---------

Soybean Intensive Management:

High Yield Study: West	181-183
At-Plant Nutritional Study	184-185
Yield to Seeding Rate Ratio	186
Irrigation Study	187
Soybean Seed Size	188
High Yield Study: East	189-190
High Management Ocean Blue Ag	230-232

Become a PTI Insider Today!



InsidePTI is a new online video series where Jason Webster and the Precision Planting Team will give an inside look into all the trials listed in this summary report in video form. Sign up today to receive these agronomic videos mailed directly to your email inbox. To sign up, simply go to [InsidePTI.com](https://insidepti.com) and soon you will get a behind the scenes look at the PTI Farm!

Become an Insider

A simple way to stay informed, as well as up to date on the research we are collecting here at the PTI Farm is to become an Insider. Subscribe to the InsidePTI weekly videos at insidepti.com for all of your agronomic needs.



2021 in Review

Precision Planting is excited to share our 4th year of PTI research farm results and findings. We hope they provide useful insights that help drive thoughtful consideration around future crop management decisions. This publication is intended to summarize and explain the many agronomic trials that were implemented in 2021. In most trials, both agronomic yield and economics are detailed to help understand return on investment. At the bottom of each trial summary page, a brief explanation is listed to show Planting Date, Hybrid or Variety, Population, Row Width, Crop Rotation, and Commodity Price/Bu. and Pricing information that pertains to the products being evaluated.

For the 2021 PTI Yield Summary Data, net returns are calculated with corn prices of \$5.00/Bu. and soybeans at \$11.98/Bu. These prices represent average **cash** prices for new crop 2021 corn from the period of October 1st 2020, thru October 1st, 2021.

During the summer of 2021, the PTI Farm hosted thousands of growers from throughout the United States. Farmers visited the PTI research farm to dive into agronomy field trials, see and understand real world agronomic problems, and were even able to experience some of the latest and greatest state-of-the-art technology in our ride and drive “SandBox” area. Field days started in July and lasted until the 2nd week of September, running Monday thru Friday of each week.

For starter fertilizer trials, most have a \$30 Reallocation credit applied to each product in testing. This approach allows us to use the total intended fertility needed for soil test build-up and yield maintenance but allows the planned use of both dry fertilizer in the fall and liquid product on the planter without spending or over-applying more nutrients than needed. To accomplish this, we reduce our dry fertilizer rates by \$30/A. to account for the reallocation. All control tests in each study get the additional \$30/A. of dry fertilizer to achieve a typical 100% program without starter fertilizer on the planter.

Fall Dry Fertilizer: \$30 Reduction + At-Plant Liquid Starter



2021 Return on Investment Performers

PTI Agronomic Study:	\$ ROI/A.	Page #
Top 10:		
1. High Management Corn	\$203.30	50-54
2. Strip Crop System	\$166.68	205
3. High Management Soybeans	\$161.10	181-183
4. Tile Drainage: 15', 30', 60' Tile Average*	\$158.00	46-47
5. Nitrogen Management: 25% Triple Split over 100% WNF	\$116.00	108-111
6. 20" Row 44K Seeding Rate vs 36K 30" Rows	\$108.76	100-104
7. Nachurs At Plant Nutritional Study: 5 Point Touch	\$90.31	55-56
8. Corn Sequential Fungicide Applications for Tar Spot Disease	\$84.52	146-148
9. FurrowForce® in No-Till Corn	\$82.70	34-36
10. Soybean FurrowJet® Starter: Marco QuickGrow LTE 8 Gal	\$74.28	222
Bottom 10:		
1. Frost Damage: No-Till vs. Conventional Tillage	\$-467.84	192-195
2. June 17 th Soybean Late Planting Date	\$-311.41	163
3. June 3 rd Corn Late Planting Date	\$-247.47	7
4. Soybean after Corn Cover Crop: Late Termination	\$-184.58	216-217
5. Nitrogen Management: 25% N Reduction	\$-152.63	78
6. 20" Row Soybean Seeding Rate: 175K compared to 100K	\$-139.96	206-208
7. Corn Planting Depth Too Deep: 3.25"	\$-90.00	11-13
8. Planter all Wrong	\$-83.00	40
9. Corn Strip Till Over No-Till	\$-81.50	156-157
10. High Speed Planting without High Speed Technology	\$-80.55	33

*Represents gross return

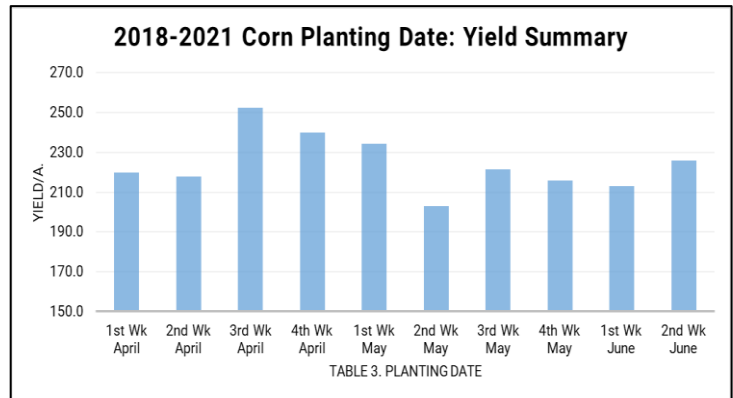
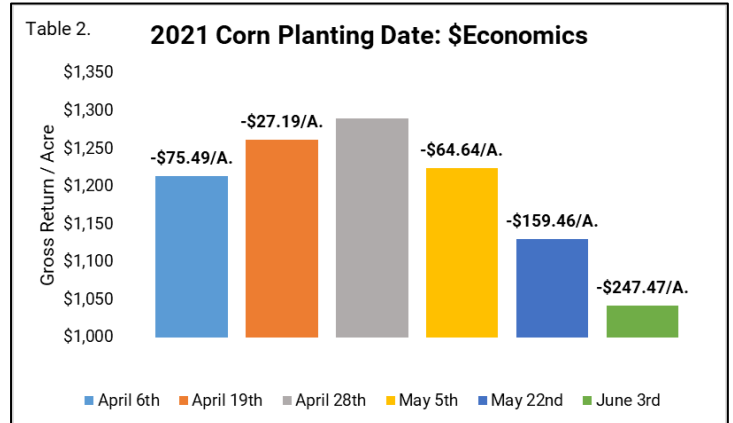
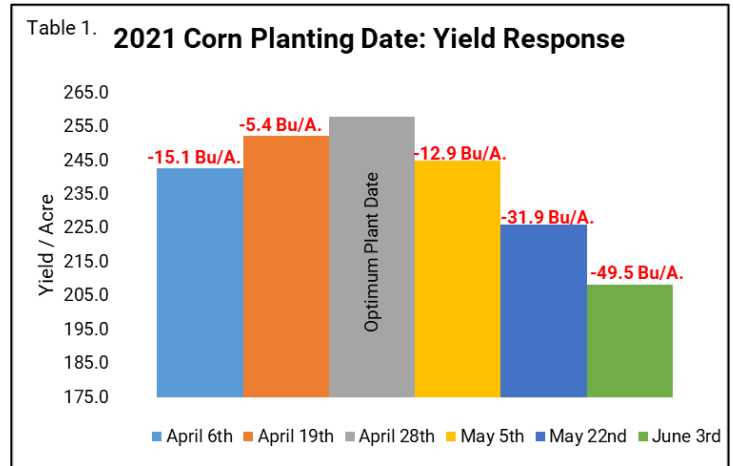
Corn Planting Date Study

Objective: To evaluate various corn planting dates throughout the spring to determine the optimum planting date. Once optimum planting date is discovered, economics can then be analyzed to determine yield loss and cost per acre when planting dates were not implemented within the optimum planting window.

Results: Corn planted on April 28th achieved this year's optimum plant date at 257.8 Bu/A. (Table 1). April 19th plant dates (just one week earlier) resulted in only **-5.4 Bu/A.** losses. As plant dates were pushed even earlier to April 6th, yield losses were recorded at **-15.1 Bu/A.** As planting dates were pushed later than the optimum plant date of April 28th, yields fell by **-12.9 Bu/A.** on May 5th, **-31.9 Bu/A.** on May 22nd, and **-49.5 Bu/A.** on June 3rd.

Table 2. illustrates the economics of the various corn planting dates. The early planting dates resulted in revenue losses of **-\$27.19/A.** to **-\$75.49/A.,** while later planting dates consisted of significant losses of **-\$64.64/A., -\$159.46/A.,** and **-\$247.47/A.** respectively.

Table 3. summarizes the average yield from week-to-week plantings over a four-year time-period from 2018-2021. To no surprise, this timeframe has average optimum corn planting date during the last two weeks of April through the 1st week of May. Ultra-early planting dates (1st and 2nd week April) have resulted in **-23.8 Bu/A.** average lower yields compared to optimum last half April and 1st week May plantings.



Corn Starter Fertilizer Response by Planting Date Study

Objective: To monitor the performance of starter fertilizer at various planting dates. When does starter fertilizer give the highest returns? Does starter fertilizer respond differently at earlier planted dates versus later? In this study we evaluate five planting dates consisting of April 6th, April 19th, April 28th, May 5th and May 22nd with and without a starter fertilizer, monitoring its performance throughout the planting season.

The starter fertilizer program used for this study consists of the following:



<u>Product</u>	<u>Fertilizer Analysis</u>	<u>Placement of Fertilizer</u>
3 Gal/A. Triple Option®	4-13-17-1S	FurrowJet® Center
3 Gal/A. Triple Option	4-13-17-1S	FurrowJet® Wings
5 Gal/A. Throwback	9-27-4-4S	Conceal® Single Band
30 Gal/A.UAN	32-0-0	Conceal® Single Band
4 Gal/A. K-Fuse	6-0-12-12S	Conceal® Single Band

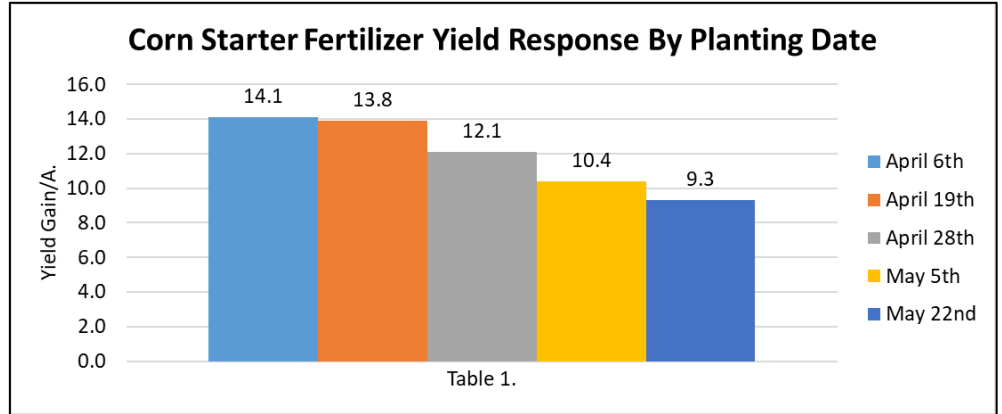
Figure 1. FurrowJet® Placement

Figure 2. Conceal® Placement

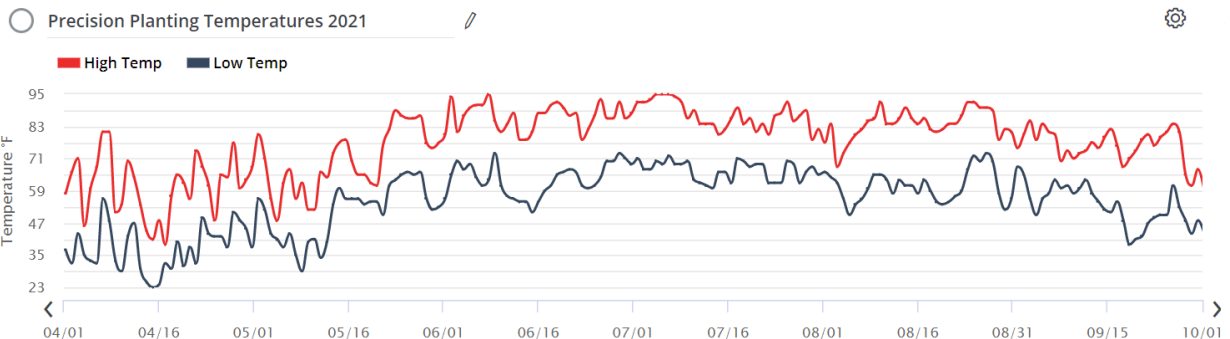
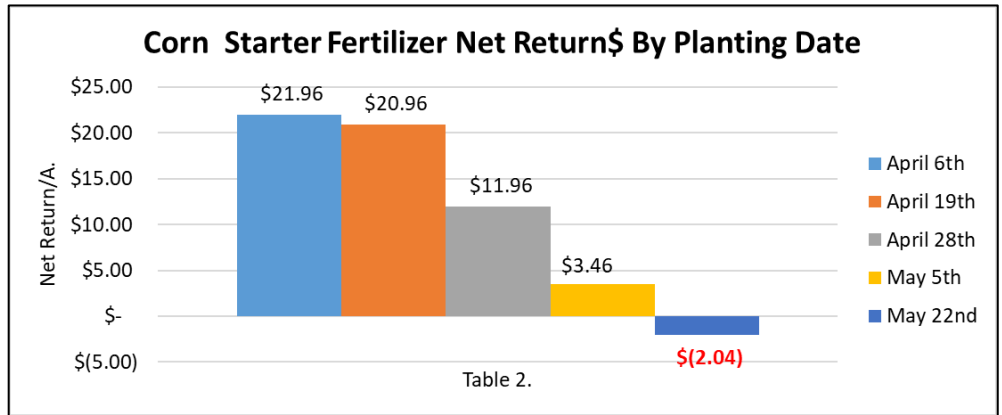


Corn Starter Fertilizer Response by Planting Date Study Continued

Results: Table 1. illustrates that every planting date achieved yield gains from our starter fertilizer program. Best yield responses from starter fertilizer came during the earlier planting events in April. April 6th resulted in the highest yield gains of +14.1 Bu/A., April 19th of +13.9 Bu/A., and April 28th of +12.1 Bu/A. All April planting dates also incurred positive economic gains ranging from +\$21.96, +\$20.96, and +\$11.96/A.



As planting dates shifted later towards warmer soils in May, starter fertilizer yield response decreased with yield gains of +10.4 Bu/A. on May 5th and +9.3 Bu/A. on May 22nd. May 5th planting entry proved positive economic gains of \$3.46/A. while May 22nd planting entries incurred negative economic losses of **-\$2.04/A.** (Table 2.).

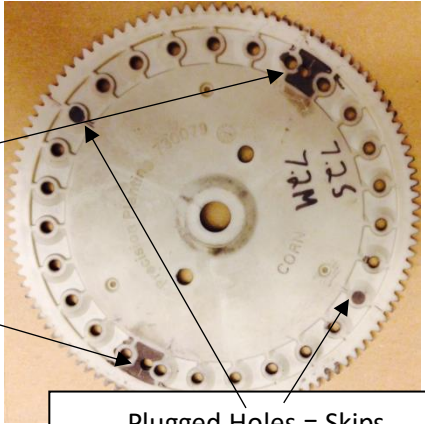


Planting Date: Varied Hybrid: GH15J91 Population: 36K Row Width: 30" Rotation: CAB Corn Price: \$5.00
 Triple Option: \$5.64/Gal Throwback: \$5.10/Gal K-Fuse: \$4.80/Gal

vSet® Planter Singulation Study

Objective: To evaluate how improper seed singulation affects corn yield. Modified vSet® seed plates with plugged and extra holes were used in order to create skips and doubles. These “goof” plates created an average of 95% spacing accuracy vs. the control at 99.5%.

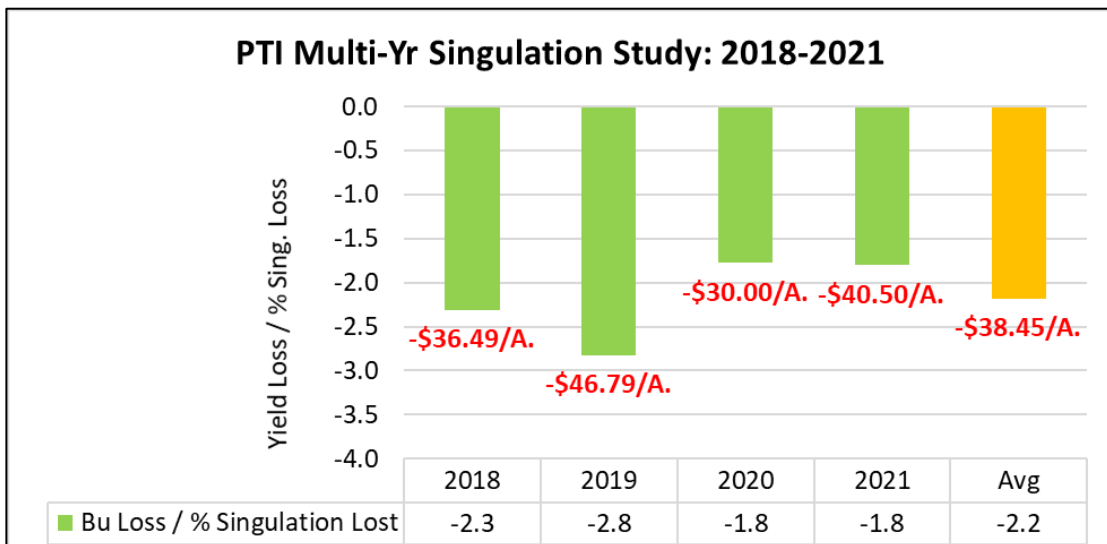
Extra Holes = Doubles



Plugged Holes = Skips

Results: The table below illustrates 95% seed singulation resulted in economic losses of **-\$38.45/A.** over a 4-yr period of 2018-2021.

Over this same time period, for each percentage of singulation lost, yield was decreased by an average of **-2.2 Bu/A.**



Planting Depth Study

Objective: To evaluate yield and economic performance of various corn planting depths consisting of 1" to 3.25" in ¼" increments.

Results: Tables 1-2. illustrate that the optimum planting depth for this study was 1.75". As planting depth was shallowed up to 1.5", yield was reduced by **-6.5 Bu/A.**, and more importantly suffered economic losses over **-\$32/A.** Further yield decline occurred at the shallowest depths of 1.25" and 1", with yield deficits of **-15.1 Bu/A.** and **-17.1 Bu/A.**, and significant economic losses ranging from **-\$75 to -85/A.**

As planting depth was increased to 2.0", a yield loss of **-7.8 Bu/A.** occurred, resulting in lower economic returns by **-\$39/A.** As planting depths went deeper to 2.25" to 2.5", yields fell by near **-16 Bu/A.** and suffered economic losses of **-\$80 - \$85/A.** Continuing to push planting depths deeper to 2.75" to 3.25" proved the highest losses in the study at **-19.1, -23.8 and -24.3 Bu/A.** with corresponding losses of **-\$95.50, -\$119.00 and \$121.50/A.**

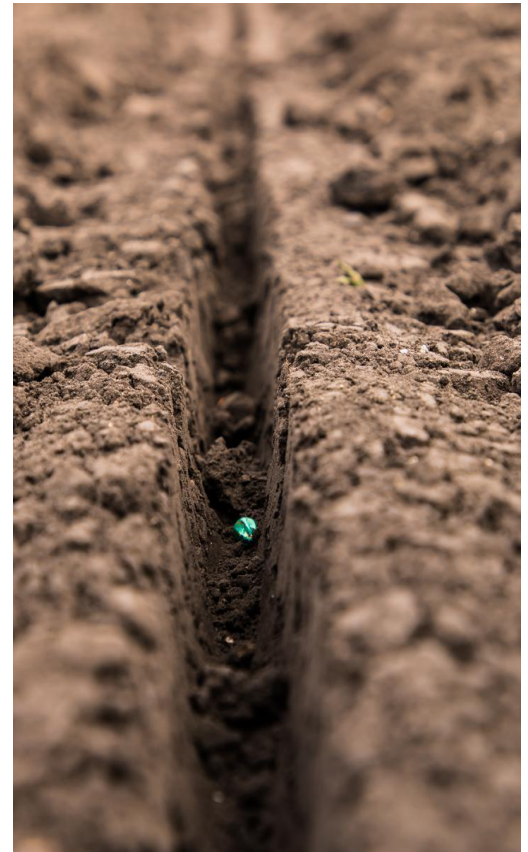
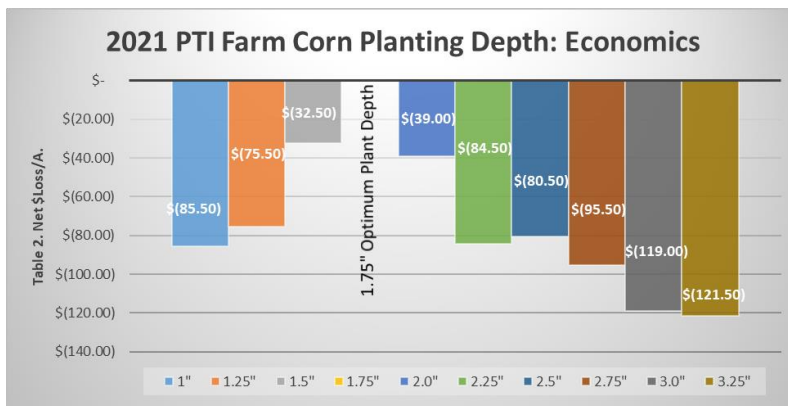
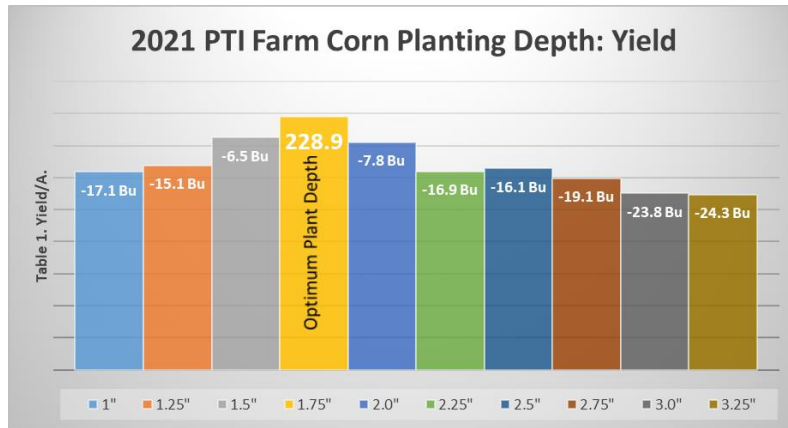


Figure 1. Seed Furrow

Planting Depth Study Continued

Figure 2. SmartFirmer® Sensor

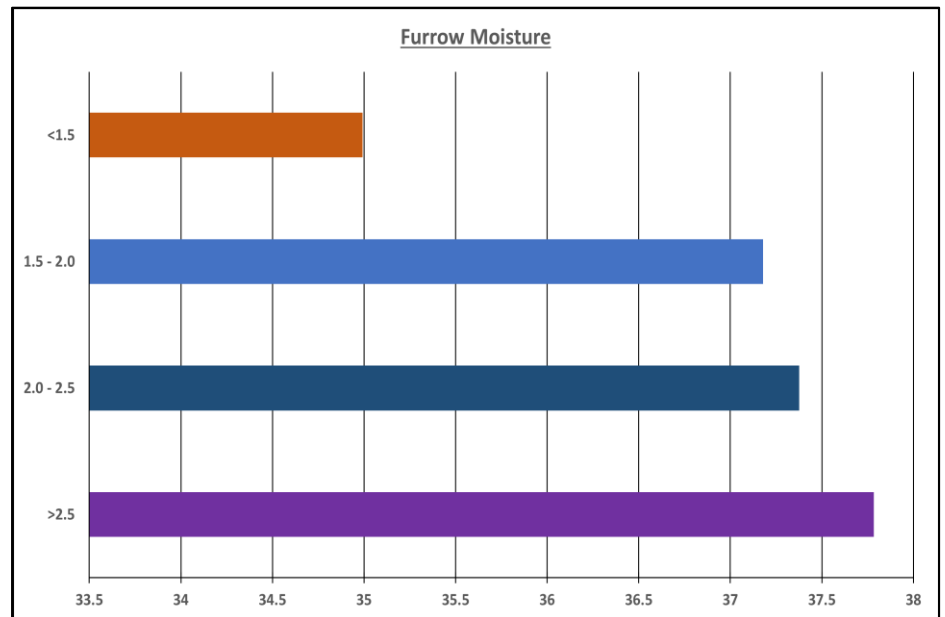
Digging seeds is a time consuming yet important task at planting time (Figure 1). Getting your eyes on the furrow where the seeds are placed, will allow you to understand if those seeds are in an environment to thrive. Is the seed being planted into adequate moisture? Until now, we didn't know this for every seed, and we were unfortunately simply guessing.



With a SmartFirmer® sensor (Figure 2) you can now have virtual eyes in the furrow. Soil moisture is a critical component for seed germination, uniform plant emergence, and ultimately crop yield. SmartFirmer® sensors gives row-by-row visibility to soil moisture in the seed furrow, allowing farmers to choose the right planting depth as soil conditions change. Currently, the recommendation for ideal furrow moisture levels to achieve adequate corn emergence, is near 32%.

The telling story with this planting depth study is actual furrow moisture. Table 3. reveals the furrow moisture reported by SmartFirmer® sensor. All planting depths were placing seed into soils with over 32% furrow moisture.

Table 3. SmartFirmer® Furrow Moisture



As planting depth increased deeper than the optimum 1.75" depth, yield losses occurred, as corn was unnecessarily planted too deep. Since it did in fact have plenty of soil moisture for germination, the deeper planting depths just caused longer emergence delays, which led to yield loss.

Planting Depth Study Continued

Using the 20|20® monitor (Figure 3) in tandem with SmartFirmer® sensors, we now have the ability to evaluate furrow moisture in real-time. Based on this real-time information, growers can make decisions based on live sensing data.

Figure 4. illustrates SmartDepth®, a unique product that takes the technology one additional step further, allowing planting depth to be changed on a planter, by section or individual row basis. This can be done manually from the tractor cab and 20|20® console, or automatically using furrow moisture values from SmartFirmer® sensors. Growers can customize their own settings to optimize both furrow moisture and planting depth values (Figure 5). This control allows growers to measure, react, and take control of planting depth to optimize emergence timing.

Figure 3. 20|20® Monitor System



Figure 4. SmartDepth® Control



Figure 5. SmartDepth® Customization Screen



Keeton® Seed Firmer Study

Objective: This study evaluates the benefits of Keeton® Seed Firmers (Figure 1). Seeds don't always land right in the bottom of the trench where they belong. With its unique, in-the-trench design, the Keeton® Seed Firmer gently firms those seeds to the bottom of the V-trench (Figure 2). The end result is even depth, correct seed-to-soil contact, and most importantly, uniform germination.

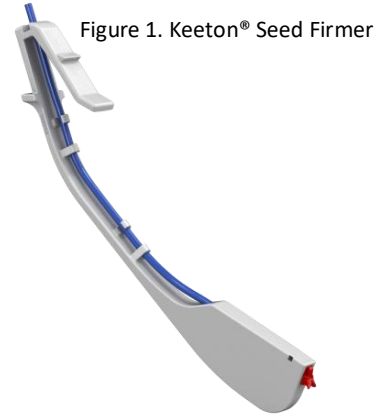


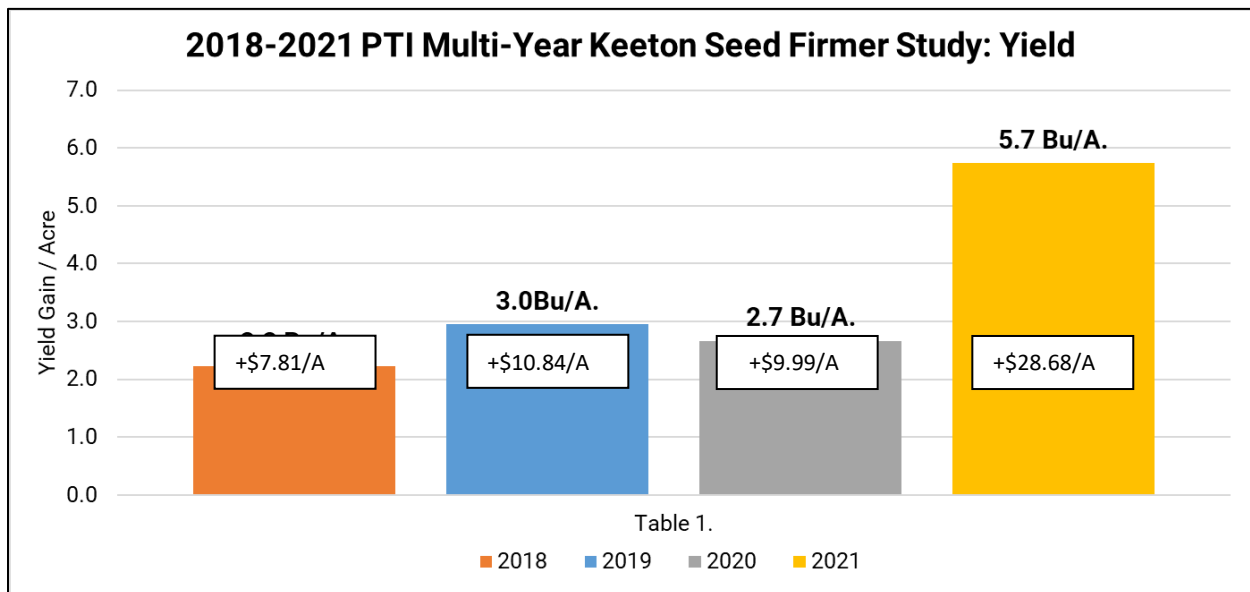
Figure 1. Keeton® Seed Firmer

Results: Table 1. illustrates multi-year yield data over the time period of 2018 – 2021 at the PTI Farm. The presence of Keeton® Seed Firmers resulted in average yield gains of +3.42 Bu/A. As for economics, this yield gain equates to additional economic gains of +\$14.33/A. compared to not using a seed firmer.

Figure 2. Good Seed-to-Soil Contact from Keeton® Firmer

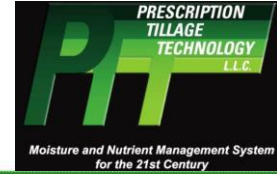


At a cost of \$35/row for Keeton® Seed Firmers and quick attach brackets for a 16-row planter, using the +\$14.33/A. increase in revenue, break-even occurs at 39 acres.



STP Opening Disc Study

Objective: This study evaluates the use of 3 different types of opening discs from Prescription Tillage Technology L.L.C.



STV STANDARD TRUE V

Standard True “V” Blade with Anti-Stubbing or Dulling Technology

- Shallow and full planting depth
- Sharp gravel and shale rock conditions
- Standard soils and planting conditions
- Standard and offset true-V planter configurations
- Available with off-set blade configurations on standard planters
- Fits John Deere, Kinze, Harvest International, Horsch, Monosem, White and Precision



STP SABRE TOOTH PLANTER

True “V” & Single Blade Applications

- 1" minimum to full planting depth
- Challenging soil and planting conditions
- Challenging residue conditions
- Standard planter configurations
- Enhances early and late root development
- 14.75" inside with 15" outside combination fits John Deere, Kinze, Harvest International, Horsch, Monosem and older White
- 15.75" inside with 16" outside combination fits newer White and Precision



STPS SABRE TOOTH PLANTER SHALLOW FILLET

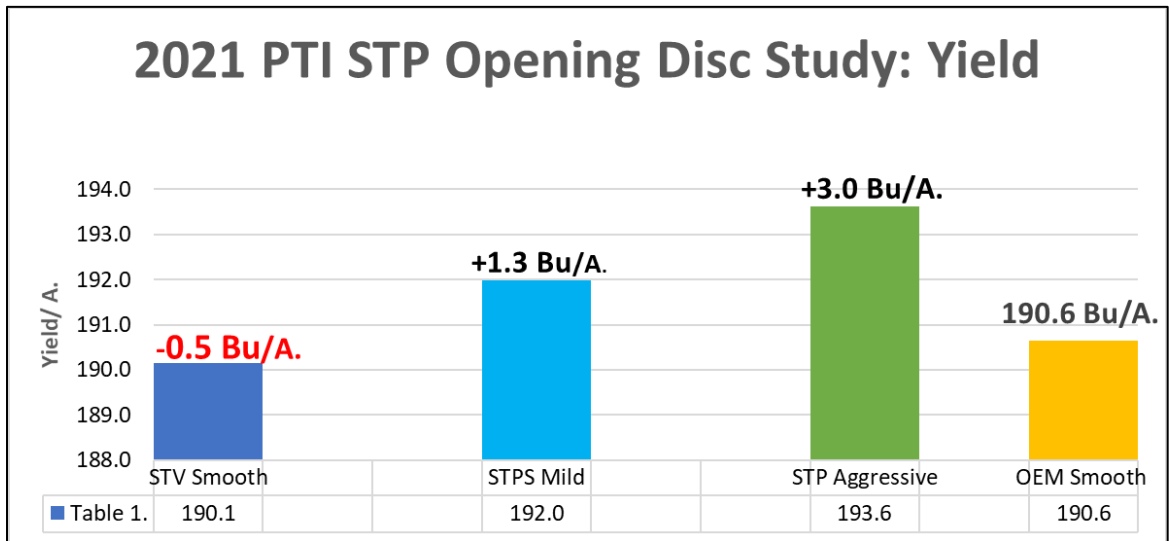
Shallow Planting Sharp Gravel & Shale Rock Conditions

- Shallow and full planting depth for cotton, canola, and shallow seed placement requirements
- Sharp gravel and rock conditions
- Challenging soils and planting conditions
- Enhances early and late root development
- .100 cut out
- 15" inside with 15" outside combination fits John Deere, Kinze, Harvest International, Horsch, Monosem and older White
- 16" inside with 16" outside combination fits newer White and Precision



Opening Disc Study Continued

Results: Table 1. Illustrates each of the Prescription Tillage Technology’s opening discs performance compared to the control. STV smooth discs had a loss of **-0.5Bu/A.** resulting in an economic loss of **-\$2.5/A.** The STPS mild discs realized a +1.3Bu/A. which equals a gain of +\$6.50/A. Finally the aggressive STP discs had a gain of +3.0Bu/A. meaning a +\$15/A. return on investment.



STP disc installed on Harvest International planter



“U” Furrow created by STP



True “V” created by standard opener discs

Reveal™ Residue Management Study

Objective: This study evaluates the yield and economic benefit of Reveal™, a frame mounted row cleaner system in a corn after corn strip-till environment.

Residue management is a necessary part of today's operation to maximize profitability. Tougher stalks and more corn-on-corn acres mean a heavier load of residue that needs to be controlled. Residue in the seed trench competes with seedlings for moisture and can harbor diseases.

Reveal™ (Figure 1-2.) is frame mounted, so unlike other row cleaners is gets rid of that row unit chatter. It has a gauge wheel that precisely controls the depth of the cleaning tines. It also has an airbag that makes sure the depth that it's set at, stays consistent. The pressure of the airbag can be controlled on the 20|20® monitor.

Figure 1. Reveal™ System



In this agronomic study, we compared the absence of row cleaners, floating row cleaners, and CleanSweep® at 20# Lift and to that of Reveal at the following notch and PSI settings:

1. Reveal™ Notch1 10# Lift
2. Reveal™ Notch1 10# Down
3. Reveal™ Notch1 20# Down
4. Reveal™ Notch 2 10# Lift
5. Reveal™ Notch 2 10# Down
6. Reveal™ Notch 2 20# Down

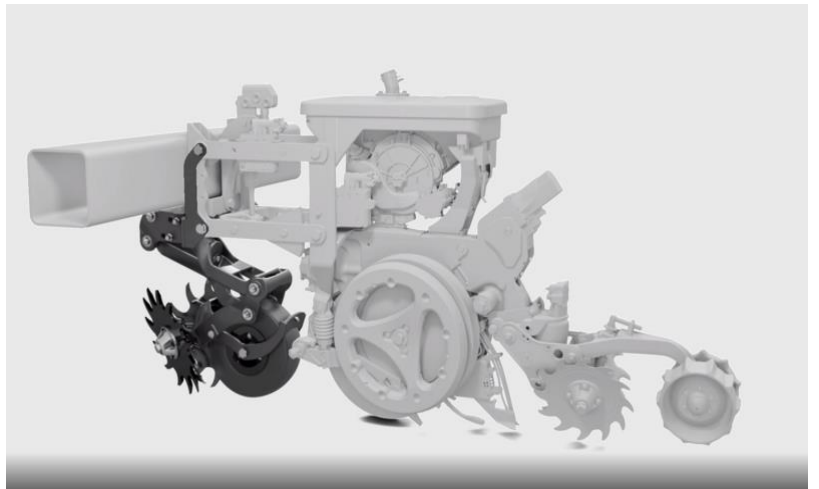


Figure 3. 20|20 System

Reveal™ Residue Management Study Continued

Results: Table 1. illustrates Reveal in general, resulted in positive yield gains of +6.8 Bu/A. compared to no row cleaners and +4.1 Bu/A. better than CleanSweep at 20# PSI Lift. Reveal™ Notch 1 settings out-performed Notch 2 by +0.8 Bu/A.

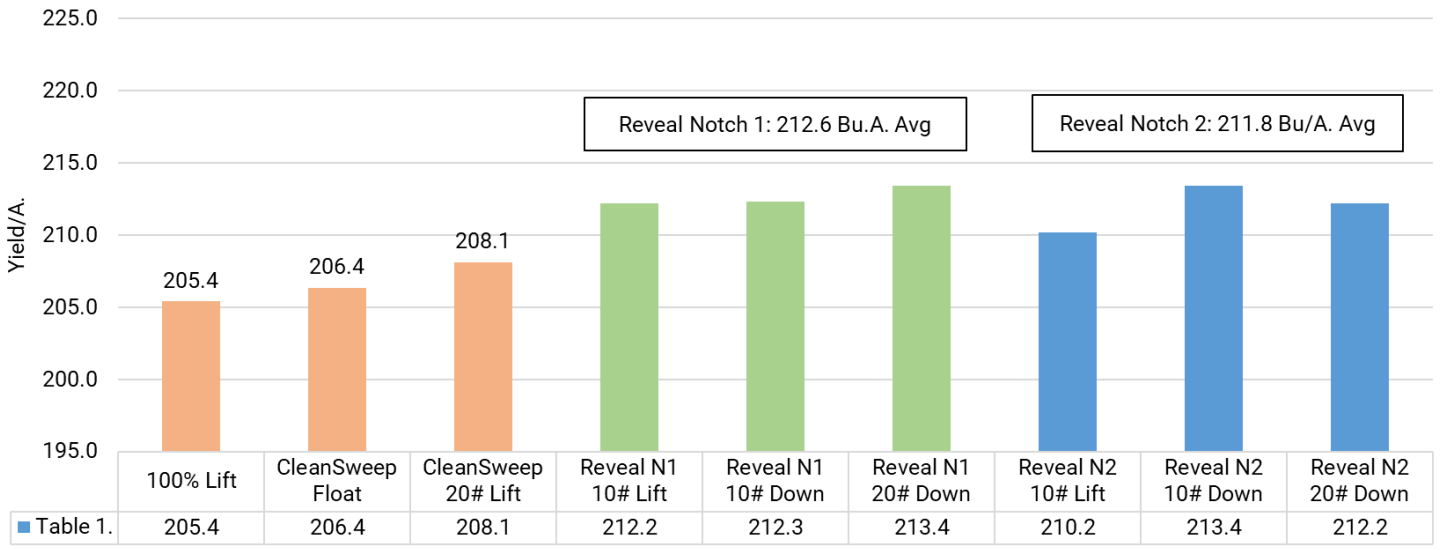


Figure 3. Reveal™ System



Figure 4. Reveal™ Depth Adjustment in Notch 1

2021 Residue Manager Study



Planting Date: 5/25 Hybrid: AgriGold 639-40 Tillage: Strip-Till Population: 36K Row Width: 30" Rotation: CAC Corn Price: \$5.00

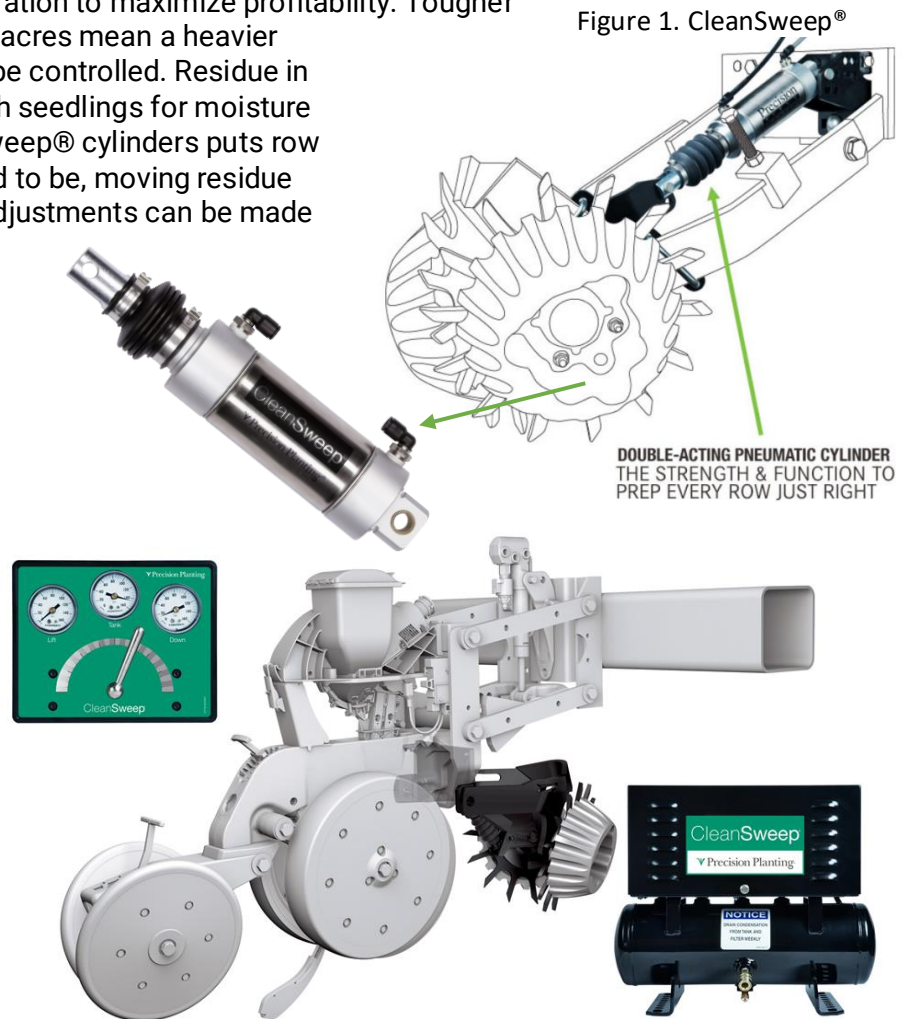
CleanSweep® Residue Management Study

Objective: This study evaluates the benefits of planter row cleaners equipped with CleanSweep® cylinders. Residue management has become a necessary part of today's operation to maximize profitability. Tougher stalks and more corn-on-corn acres mean a heavier load of residue that needs to be controlled. Residue in the seed trench competes with seedlings for moisture and harbors disease. CleanSweep® cylinders puts row cleaners right where they need to be, moving residue but not the soil. Continuous adjustments can be made as field conditions change with the cab-mounted controller to easily lift or make more aggressive adjustments.

In this study, we use air pressure to adjust CleanSweep® cylinder settings on Yetter 2967 spike row cleaners to allow the ability to change and evaluate the aggressiveness of row cleaners. These settings were then evaluated to study yield and economic advantages.

These agronomic settings consisted of:

7. Lifting the row cleaners 100% to simulate the lack of row cleaners.
8. A "floating" (0# psi) position that allows the row cleaner to ride along top of the soil surface with no air control, lift, or down-pressure.
9. 20# of air down-pressure, just aggressive enough to wipe crop residue and clods out of the way to lead a clean path ahead of the planter gauge wheels and seed disc openers.



CleanSweep® Residue Management Study Continued

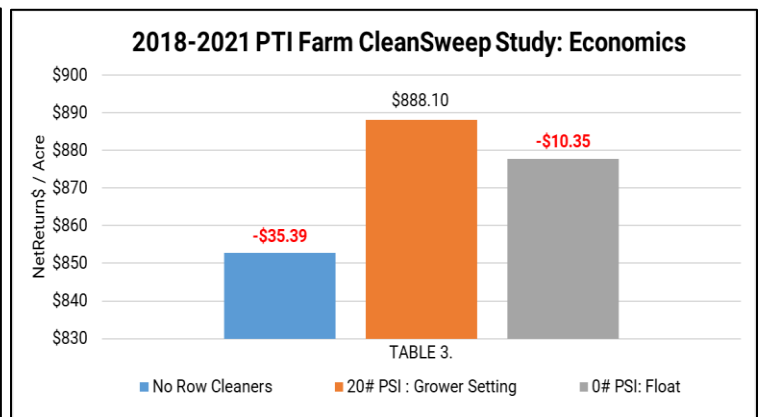
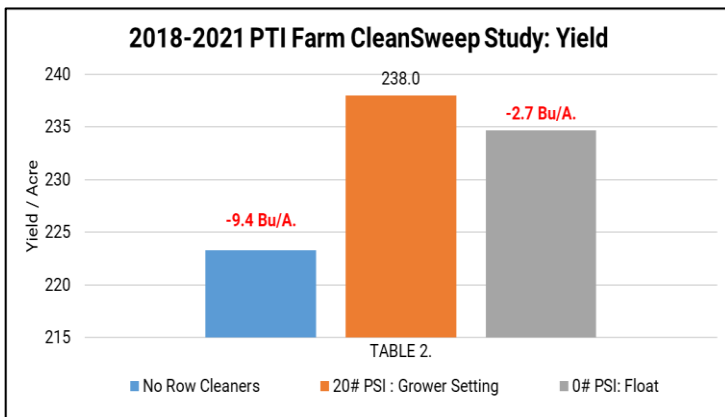
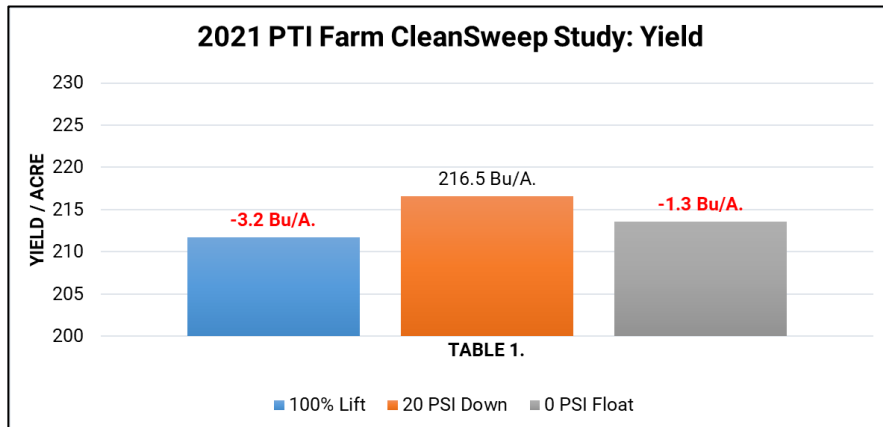
Results: Table 1. illustrates CleanSweep® cylinder yield results from the PTI Farm in 2021. Row cleaners provided a yield benefit of +3.2 Bu/A, compared to the 100% lift setting of no row cleaners. Floating row cleaners proved losses of **-1.3 Bu/A.** compared to the more aggressive setting of 20#psi down.

Figure 2. Yetter Row Cleaners with CleanSweep®



Tables 2-3 summarize multi-year average yield and economic gains from CleanSweep® cylinders during the growing seasons of 2018-2021. During this time-period, row cleaners equipped with CleanSweep® cylinders at 20#psi down realized +9.4 Bu/A. yield gains compared to using no row cleaners. These gains resulted in gross revenue increases of +\$35.39/A.

This same 20#psi setting also improved yields over the 0# float position by +2.7 Bu/A. and consequently improved revenue by +\$10.35/A.



Planting Date: 5/25 Hybrid: AgriGold 639-40 Tillage: Strip-Till Population: 36K Row Width: 30" Rotation: CAC Corn Price: \$5.00

Multi-Year Seed Trench Residue Management Study

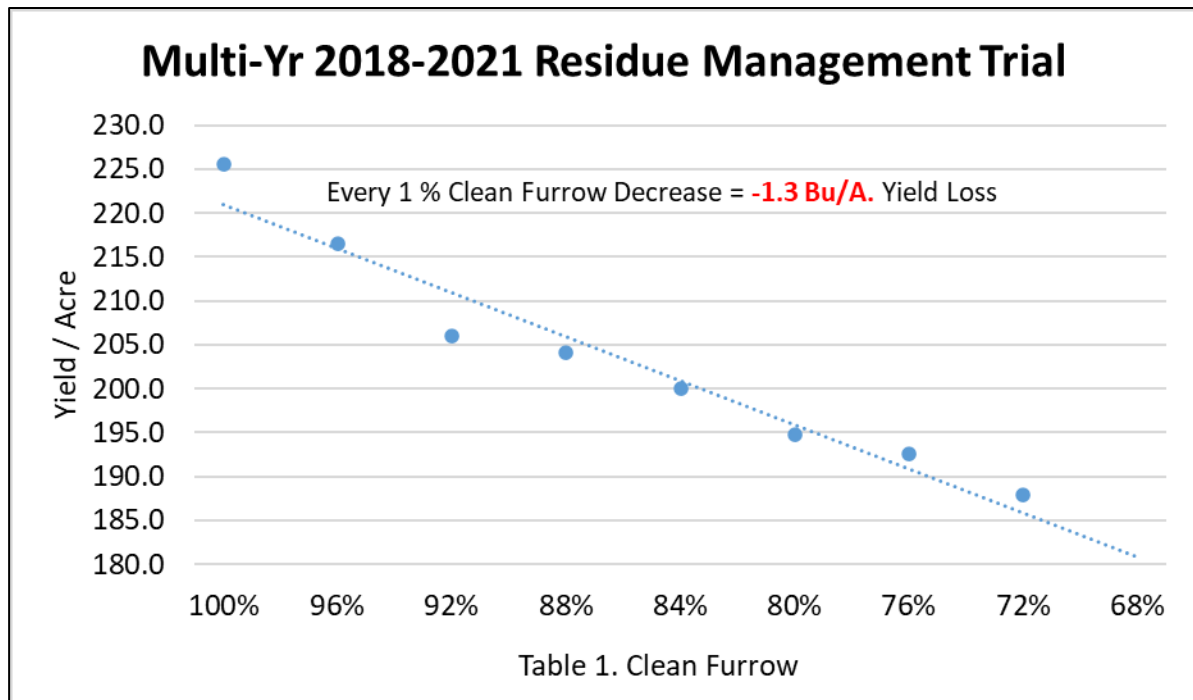
Objective: This multi-year study evaluates the impact of residue in the seed trench at planting (Figure 1.) Plant residue in the seed furrow can rob moisture away from the seed, cause air pockets, harbor disease and create a lower percentage of seed-to-soil-contact. All these factors can delay germination and impact corn yields. This study attempts to quantify corn yield loss from varying percentages of residue on the seed at planting.



Figure 1.

To create a controlled environment, manual inoculation of corn residue was placed directly on corn seed in the furrow at percentages from 100% to 70% clean furrows.

Results: Table 1. illustrates the strong relationship of yield response to residue in the furrow. From 2018 to 2021, data suggests that every 1% loss in clean furrow decreased corn yield by **-1.3 Bu/A**. It should be noted that this controlled study only applies residue directly on the seed, with no other residue being distributed between the seed in the furrow. In typical field settings, residue would more than likely be distributed throughout the seed furrow, thus increasing the total amount of residue, and consequently causing a higher degree of corn yield loss. As a result, this summary of loss could be somewhat conservative.



Multi-Year Seed Trench Residue Management Study Continued

Figure 2. illustrates the ear size degradation when residue was inoculated in the seed trench. The top row of ears designates a clean furrow, while the two bottom rows display ears

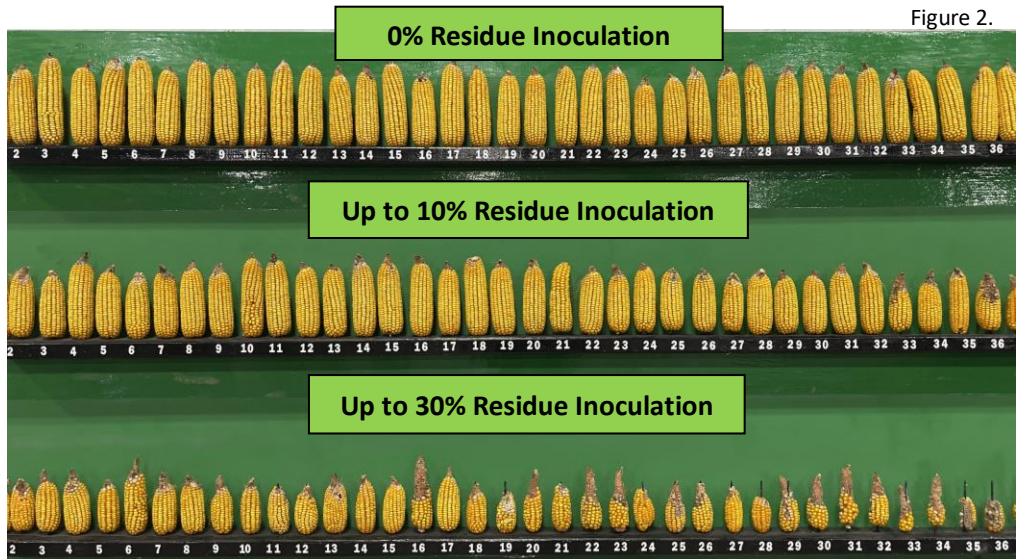


Figure 2.

where manual inoculation of residue occurred. As clean furrow decreased, ear weight and size were dramatically reduced, indicating the consequences of residue in the furrow at planting.

SmartFirmer (Figures 3-4.) is a seed-firmer sensor that measures the furrow as it is firming each seed into the bottom of the trench. SmartFirmer helps to monitor the environment that seed is being placed into and helps determine what type of in-field variability exists. SmartFirmer allows you to measure the quantity of in-furrow residue and then adjust row cleaners (Figure 5.), thus ensuring residue won't limit seed moisture uptake or harbor disease.

Figure 3. SmartFirmer® Sensor



Figure 5. Row Cleaners



Figure 4. SmartFirmer Sensing Residue



Planting Date: 5/25

Hybrid: AgriGold 645-16

Population: 36K

Row Width: 30"

Rotation: CAC

Corn Price: \$5.00

Multi-Year Day of Emergence Study

Objective: This multi-year study illustrates the impact of yield loss when corn plants emerge from the soil surface on an inconsistent basis. Flag testing implementation (Figure 1.) was used to monitor the emergence timing of young plants each year. As corn first started to emerge from the soil surface, flags were placed at five different timings to identify the emergence of all plants within the study.

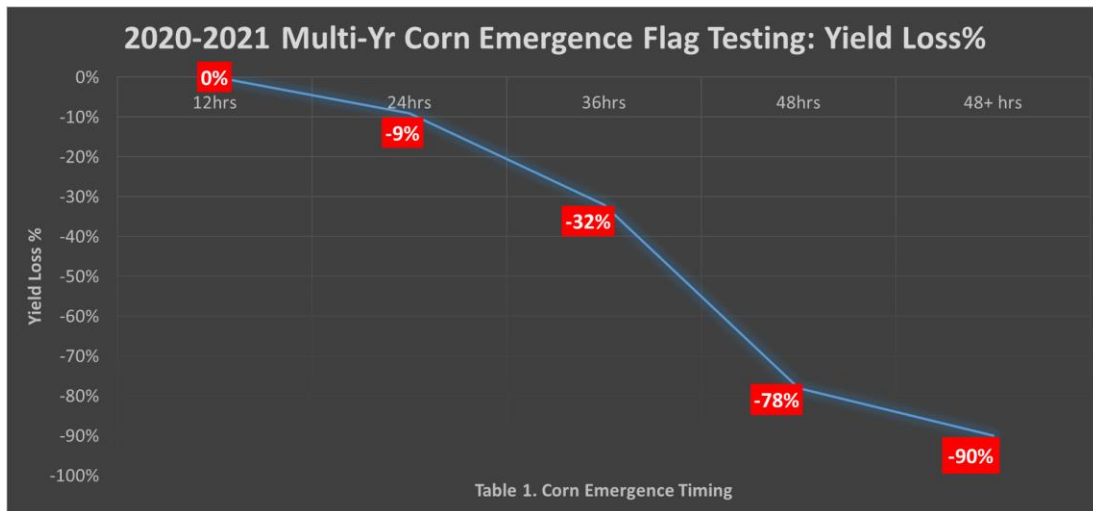
Figure 1.



Protocol:

- 12 hours =** 1st initial plants to emerge
- 24 hours =** Plants that emerged 24 hours later
- 36 hours =** Plants that emerged 36 hours later
- 48 hours =** Plants that emerged 48 hours later
- 48+hours=** Plants that emerged >48 hours later

Results: Manual ear checks were completed to calculate potential yield loss from late emerging plants. Table 1. below summarizes yield loss as emergence varied over the 2-year study. Plants that emerge in the first 12 hours are considered the best achievable performance and therefore used as the baseline control with 100% yield potential. As plants emerged 24 hours later, **-9%** yield losses were realized compared to the first emergers. As emergence continued to 36-hour delay, yield fell to **-32%** losses. 48-hour delay in emergence resulted in yield deficits of **-78%** and finally, the latest emergers that came up >48-hours proved devastating losses of **-90%** of yield.



Planting Date: May 8th Hybrid: DK 59-82 Population: 36K Row Width: 30" Rotation: CAB Corn Price: \$5.00

2021 Crop Year Day of Emergence Study

Objective: This study evaluates the impact of yield loss when corn plants emerge from the soil surface on an inconsistent basis. 12-hour flag testing was implemented to monitor the emergence timing of young plants. As corn first started to emerge from the soil surface, flags were placed at five different timings to identify the emergence of all plants within the study (Figures 1-2).

Figure 1. 24-hour Late Emerging Plant



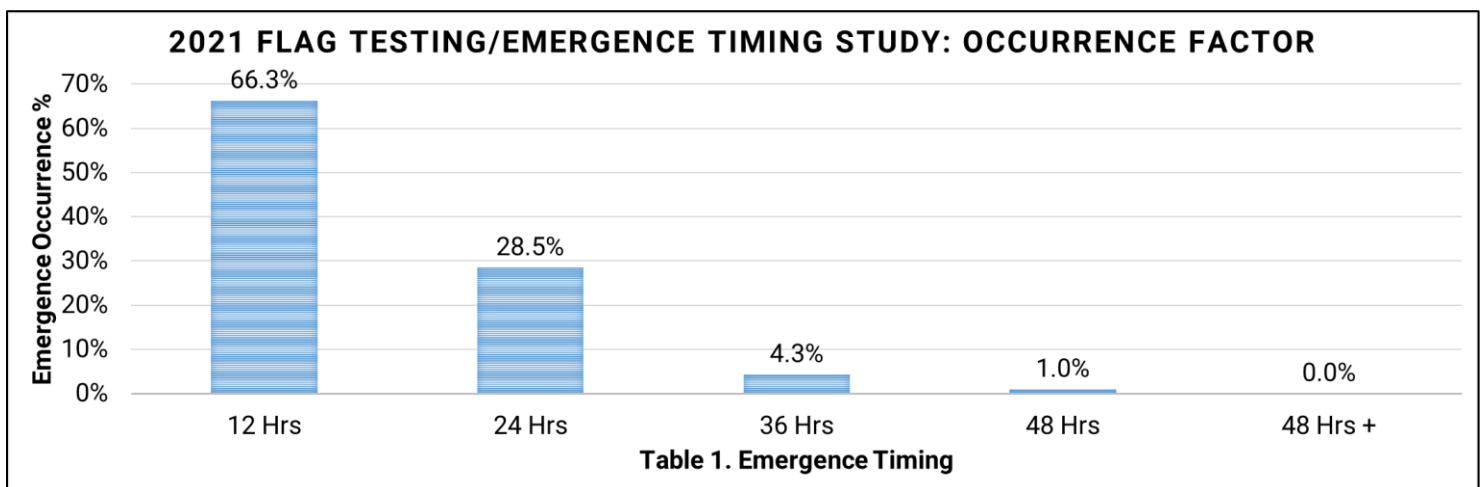
Figure 2. 12-Hour Flag Testing



Protocol:

- 12 hours =** 1st initial plants to emerge
- 24 hours =** Plants that emerged 24 hours later
- 36 hours =** Plants that emerged 36 hours later
- 48 hours =** Plants that emerged 48 hours later
- 48+hours=** Plants that emerged >48 hours later

Results: Table 1. illustrates the occurrence factors of emergence timing at each 12-hour interval. 66.3% of all plants did in fact emerge in the first 12-hour time-period. Plants that emerged just 12-hours later in the 24-hour time-period totaled 28.5% occurrence, while 36-hours tallied 4.3%, 48-hours 1% and 48+hours tallied 0%.



2021 Crop Year Day of Emergence Study Continued

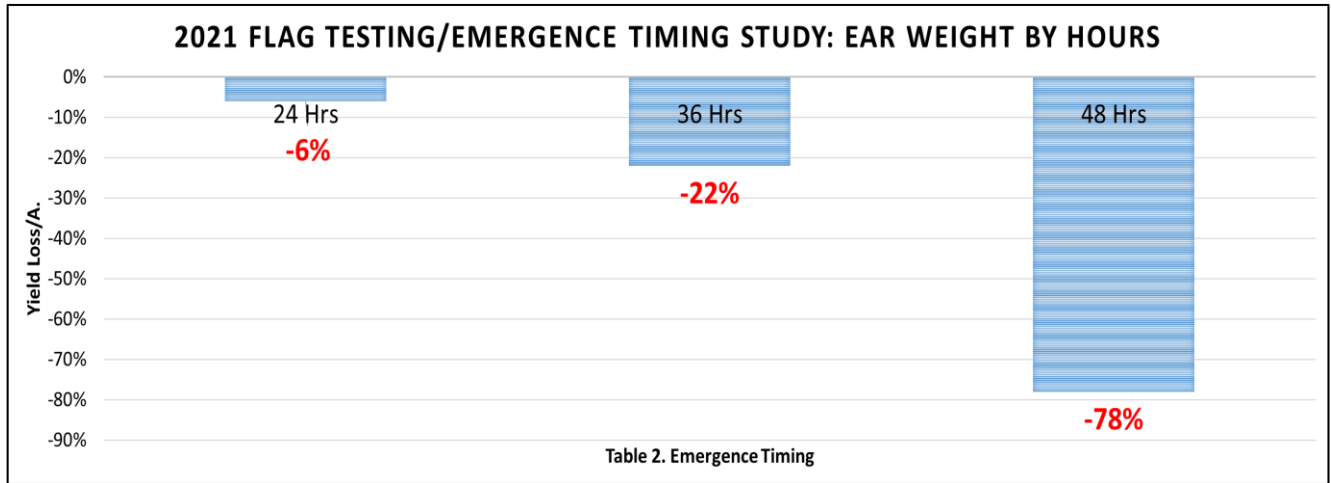


Table 2. reveals the yield losses from each occurrence factor from Table 1. Using 12-hour emergence as the ideal baseline control; as corn emerged just 12-hours later, yield fell by **-6%**, at the 36-hour emergence yield fell by **-22%**, and at 48 hours yield fell **-78%**. In this year’s study, zero late emergers occurred at the >48-hour emergence timing.

Pictured to the right is an ear board display of corn ears collected from this 2021 study at each emergence timing interval. The entire top row represents the baseline of 12-hour emergence. As each 12-hour emergence occurs, the ear board displays the ear size and yield loss associated from emerging late and competing with surrounding plants for water, nutrition, and sunlight.

In summary, uniform emergence is critical to maximize corn yield. Any delay of emergence can be significant in reducing ear size and weight and ultimately corn yield. We encourage growers to conduct flag testing/emergence timing studies to monitor individual performance in your fields. Contact your local Precision Planting Premier Dealer for free flag test emergence kits for the 2022 spring season.



Corn Closing Wheel System Emergence Timing and Yield Study

Objective: This study evaluates the impact of yield loss when corn plants emerge from the soil surface on an inconsistent basis because of improper planter closing systems. Planter closing systems are designed to close the seed trench, eliminate sidewall compaction/smearing, remove air pockets, all at the same time achieving good seed-to-soil contact. This study evaluates the emergence timing and yield differences of five distinct types of closing wheel systems in a conventional tillage, corn soybean crop rotation.



FurrowForce® Closing and Sensing Control System:

- Advantages: Lifts and fractures sidewall compaction/smear
2nd stage stitching, removal of air pocket
Automatic sensing/control of soil variability
- Disadvantages: Rocks can be problematic, increased cost



Non-Sensing Dual Rubber Closing System:

- Advantages: Sealing or "Pinching"
- Disadvantages: Difficult to lift and fracture sidewalls



Non-Sensing Dual Yetter Poly Twister™ Closing System:

- Advantages: Lifts and fractures sidewall compaction/smear
Center ring acts as depth maintainer
- Disadvantages: Lightweight wheels require increased tension



Non-Sensing Dual Cruiser Xtreme Closing System:

- Advantages: Lifts and fractures sidewall compaction/smear
Center ring acts as depth maintainer
- Disadvantages: Can be aggressive

Corn Closing Wheel System Emergence Timing and Yield Study



Dual Martin-Till® Dimple Spike™ Closing System:

- Advantages: Lifts and fractures sidewall compaction/smear
 Versatile heavy wheel, great for reduced tillage
 Depth Maintaining
- Disadvantages: Extra weight can be aggressive

12-hour flag testing (Figure 1.) was implemented in this study to monitor the emergence timing of young plants in each of the closing wheel applications. As corn first started to emerge from the soil surface, flags were placed at five different timings to identify the emergence of all plants within the study.

Protocol:

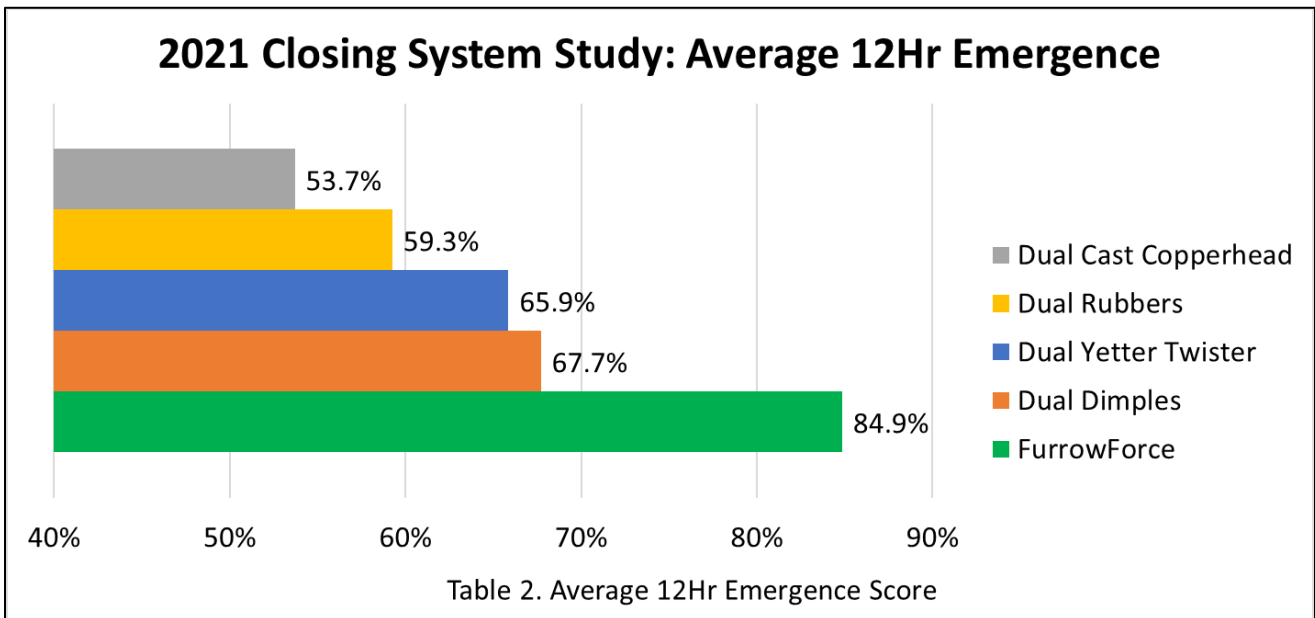
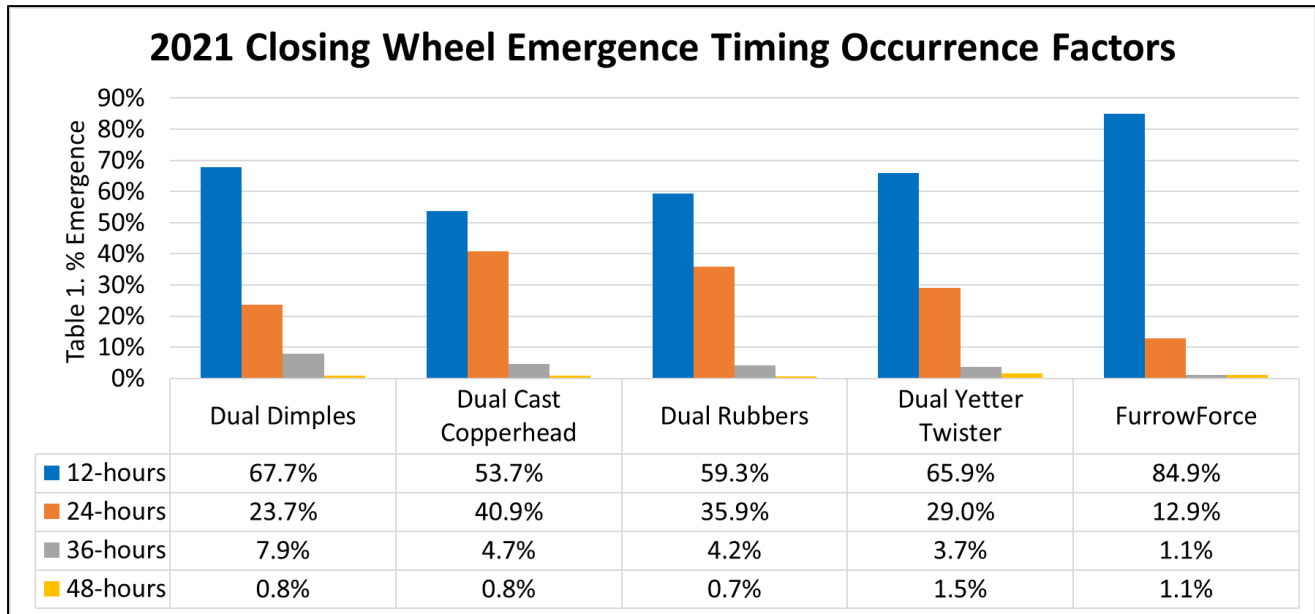
- 12 hours =** 1st initial plants to emerge
- 24 hours =** Plants that emerged 24 hours later
- 36 hours =** Plants that emerged 36 hours later
- 48 hours =** Plants that emerged 48 hours later
- 48+hours =** Plants that emerged >48 hours later



Figure 1. 12-hour Flag Testing

Corn Closing Wheel System Emergence Timing and Yield Study

Table 1. illustrates the emergence timing percentage of each closing wheel system at the 12, 24, 36, and 48 hour intervals. FurrowForce® obtained the highest average 12-hour occurrence factor at 84.9%, while all non-sensing systems ranged from 53.7% to 67.7%. Table 2. summarizes 12-hour emergence by closing wheel system.



Corn Closing Wheel System Emergence Timing and Yield Study

Table 3. depicts yield loss at each emergence interval for each closing system. Every closing system incurred net yield loss, due to no individual system being able to achieve the coveted 100% 12-hr emergence. However, the automatic two stage FurrowForce® system incurred on-average -49.5% less overall yield losses than non-sensing closing systems

2021 Closing Wheel Yield Loss/A. by Emergence Timing

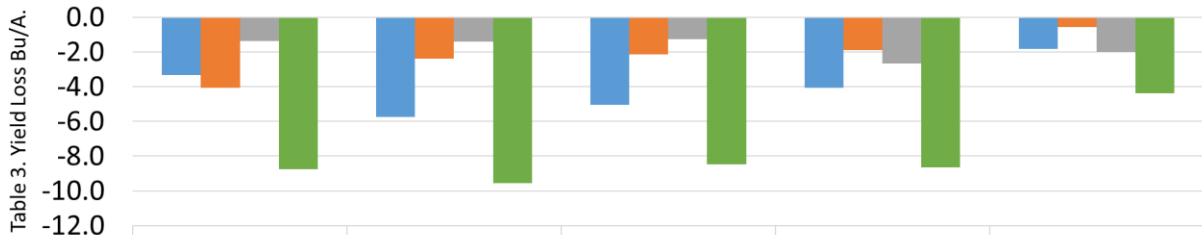


Table 3. Yield Loss Bu/A.

	Dual Dimples	Dual Cast Copperhead	Dual Rubbers	Dual Yetter Twister	FurrowForce
24Hrs	-3.32	-5.74	-5.04	-4.08	-1.81
36Hrs	-4.06	-2.39	-2.15	-1.90	-0.55
48Hrs	-1.37	-1.42	-1.28	-2.67	-2.01
Total Yield Loss	-8.75	-9.55	-8.47	-8.64	-4.38

Closing Wheel System

2021 Closing Wheel Emergence Timing Economic Losses

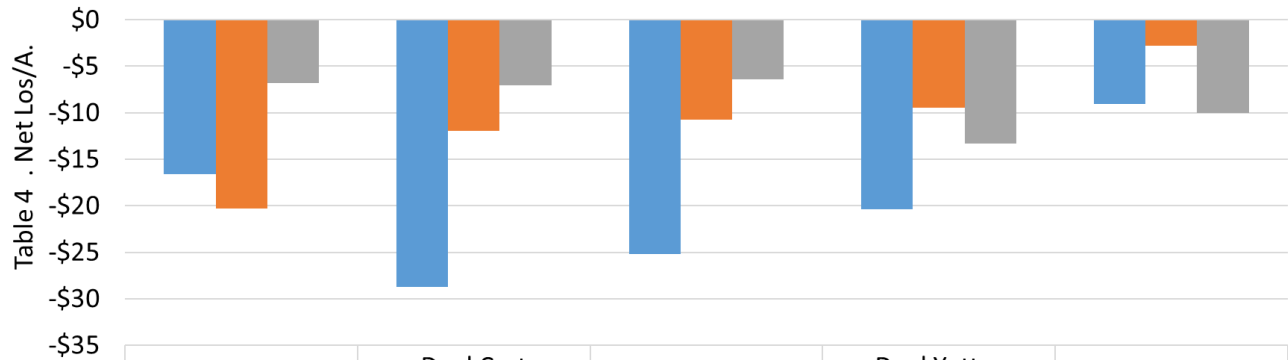
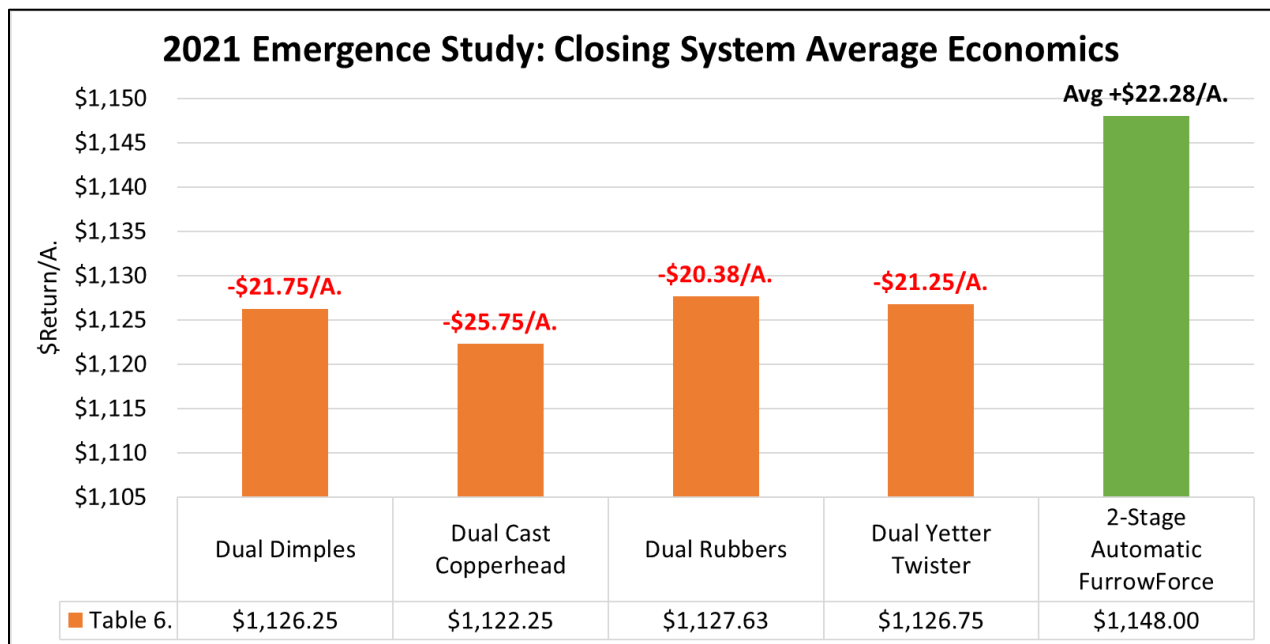
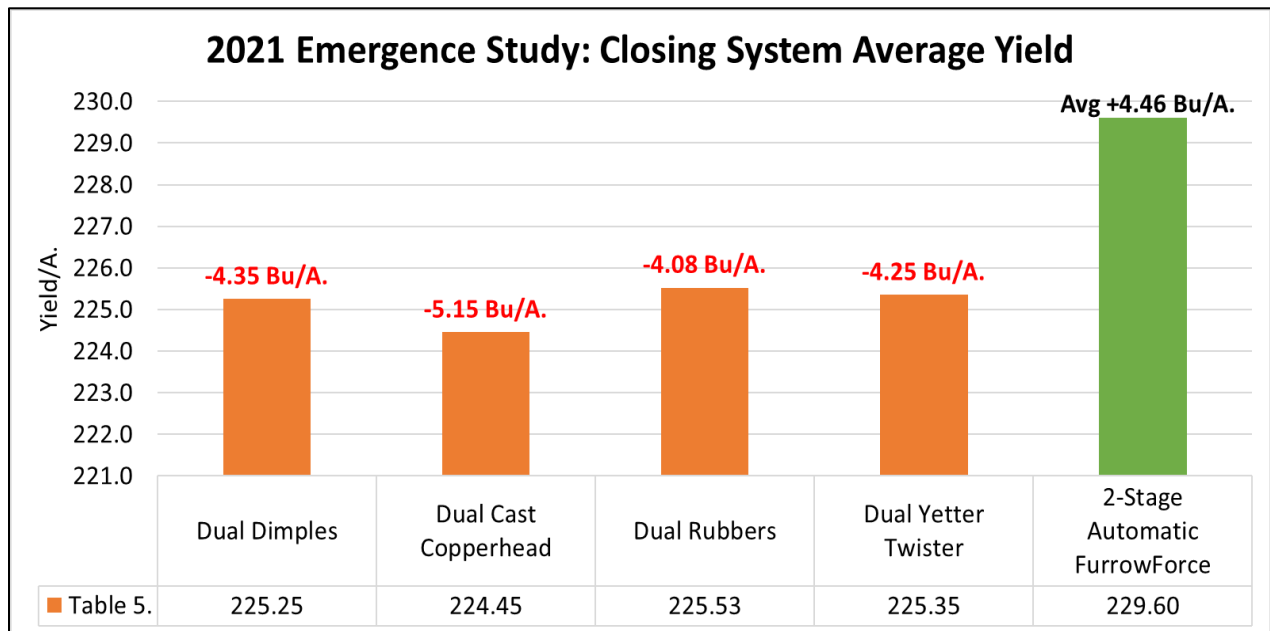


Table 4 . Net Los/A.

	Dual Dimples	Dual Cast Copperhead	Dual Rubbers	Dual Yetter Twister	FurrowForce
24-hour	\$(16.61)	\$(28.70)	\$(25.21)	\$(20.38)	\$(9.06)
36-hour	\$(20.28)	\$(11.96)	\$(10.75)	\$(9.48)	\$(2.76)
48-hour	\$(6.85)	\$(7.08)	\$(6.40)	\$(13.33)	\$(10.05)

Corn Closing Wheel System Emergence Timing and Yield Study

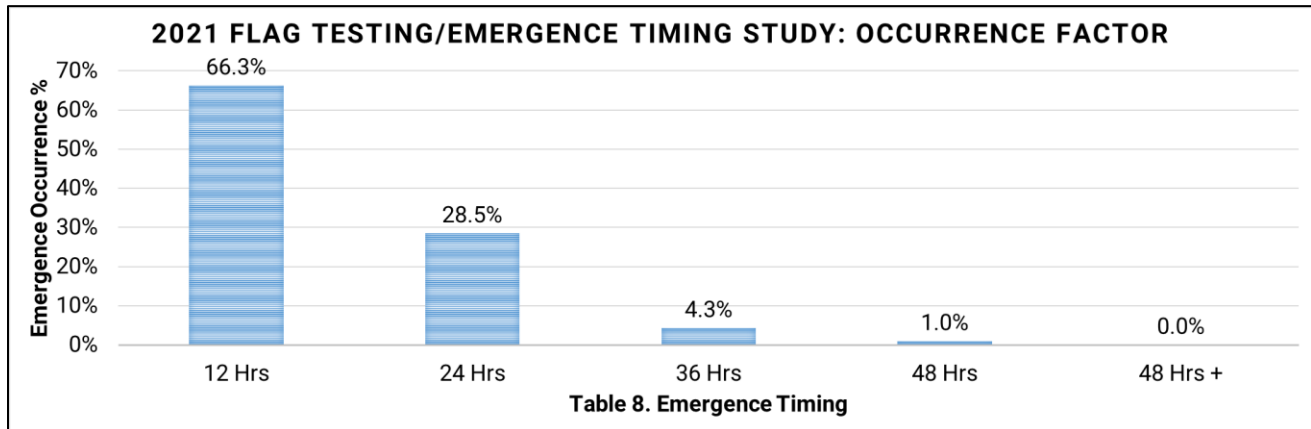
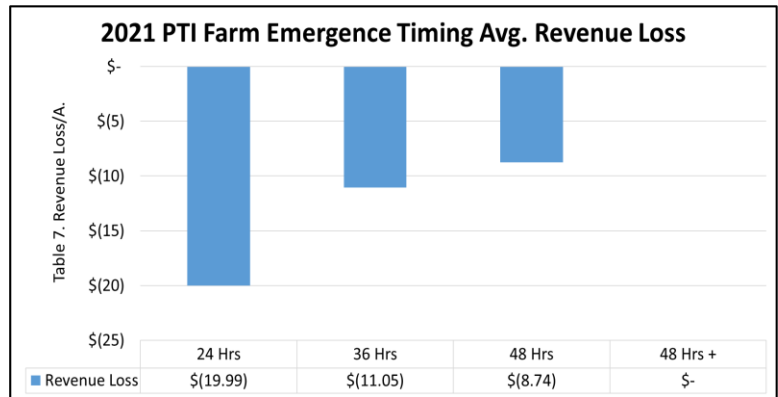
Tables 5-6. illustrate the average yield and resulting economic losses of all single-stage non-sensing closing systems compared to that of the 2-stage automatic FurrowForce® sensing system. FurrowForce® outyielded all other closing systems by an average of +4.46 Bu/A., while obtaining additional revenue of +\$22.28/A.



Corn Closing Wheel System Emergence Timing and Yield Study

In summary, the 2-stage automatic sensing FurrowForce® system achieved the highest 12-hour emergence, along with the lowest frequency of late emergers at 24, 36, and 48-hours. As a result, the FurrowForce® closing system garnered overall revenue gains of +\$22.28/A.

To help explain this, Table 7. illustrates the average overall revenue loss from all closing systems. Corn that emerged just 12-hours later (24-hour emergence) resulted in the largest revenue losses in the study at **-\$19.99/A**. One might think that the last emergers in the 36,48, and 48+-hour timing would be the highest overall losses on a per acre basis, however losses are based on how often the later emergence occurs. The 24-hour emergence timing was the highest occurrence level of all emergence timings at 28.5%, while 36-hour and 48-hour late emergers only occurred at 4.3% and 1% respectively (Table 8). As a result, the overall highest corn yield loss occurred at the 24-hour emergence timing.



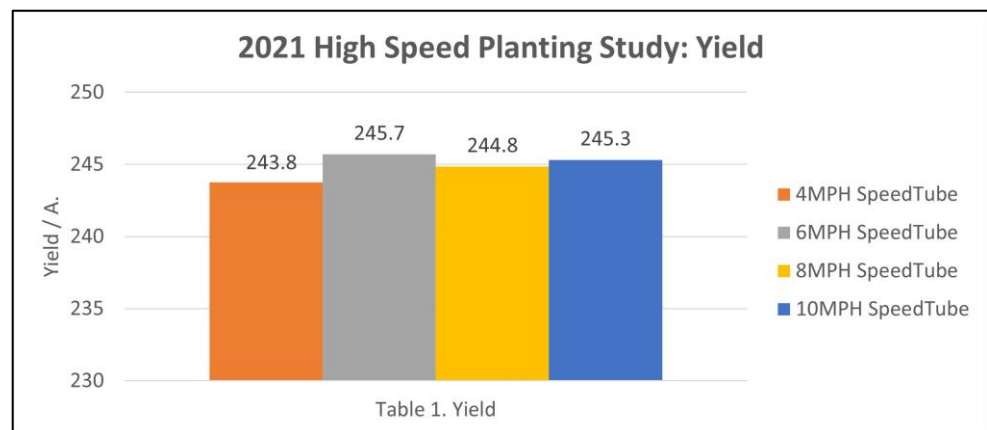
In conclusion, the goal to higher corn yield is uniform emergence. When sporadic emergence occurs, yield is sacrificed. Using an automated 2-stage, sensing-based, closing system allows the ability to fracture and lift side-wall smear, remove air pockets, and above all create the same carbon copy furrow giving each seed the same resistance that ultimately results in uniform emergence timing.

SpeedTube® Corn High Speed Planting Study

Objective: To evaluate yield response of planting speeds of 4, 6, 8, and 10 MPH with a SpeedTube® system. This high-speed planting technology takes the place of conventional seed tubes and consists of a flighted belt. By transporting each seed to the furrow, there is no opportunity for seeds to ricochet into the trench. Even at twice normal planting speeds, seed arrives safely at the bottom of the trench, spaced evenly, every time.



Results: Corn yield from planting speeds of 4 to 10 MPH only varied 1.9 Bu/A. between all speed intervals. This yield difference represents a deviance of **-0.5%**. With traditional planting speeds typically near 5 mph, this data would suggest that growers could plant twice as fast without sacrificing planter performance. Our experience with high-speed planting at the PTI Farm has been important two-fold. First, high-speed planting has allowed us to be patient and wait for fields to get fit, then we are confident we can plant quickly in those good planting conditions. Second, planting windows can be brief due to frequent rains throughout the spring, allowing high speed planting to achieve more acres planted daily within these windows.



WaveVision® SeedTube Corn High Speed Planting Study

Objective: To evaluate yield response of planting speeds of 4, 6, 8, and 10 MPH with a WaveVision® SeedTube system. WaveVision is a seed sensor that counts only seeds and not dust, giving you confidence that the population you see on your monitor is the population that you're planting. WaveVision® does not incorporate an optical sensor in the housing, meaning there is no opportunity for seeds to ricochet into the trench. Instead, a high-frequency radio waves to measure mass instead of shape.

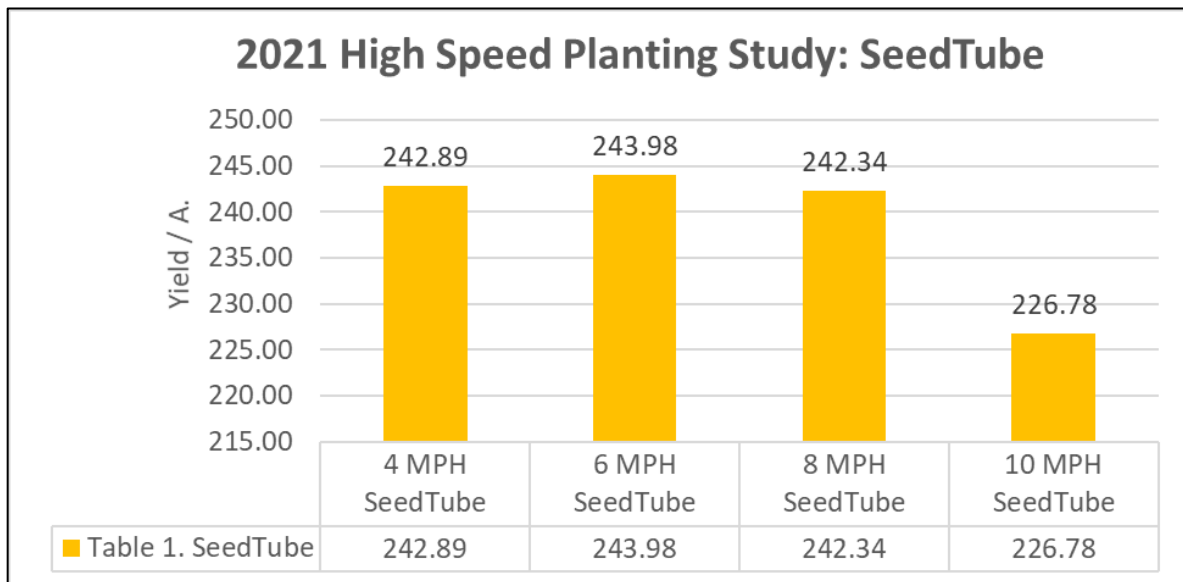
Figure 1. WaveVision® SeedTube



Figure 2. 20|20® Monitor System



Results: Corn yield from planting speeds of 4 to 8 MPH varied only -1.64 Bu/A., however when planting speed was pushed up to 10 MPH corn yield fell significantly by **-16.20 Bu/A.** compared to average 4,6, and 8 MPH planting speeds.



Corn Tillage/Closing Wheel Study

Objective: To evaluate the performance of a single-stage, non-sensing and two-stage automatic sensing closing systems in five different tillage practices including conventional, strip, vertical, in-line rip and no-till.

Closing systems are designed to close the seed trench, eliminate sidewall compaction/smearing and remove air pockets, all while achieving good seed-to-soil contact. This study evaluates the two distinctly different types of closing wheel systems including the following:



FurrowForce® Closing and Sensing/Control System:

Advantages:

- Lifts and fractures sidewall compaction/smear
- 2nd stage stitching, removal of air pocket
- Automatic Sensing of soil variability
- Automatic Control to ensure proper settings

Disadvantages: Rocks can cause plugging



Dual Yetter Poly Twister™ Spike Closing System:

Advantages:

- Lifts and fractures sidewall compaction/smear
- Center Ring acts as depth maintainer

Disadvantages: Lightweight wheels require increased tension

- Manual T-Handle Control
- Spring Variability
- Non-Sensing to Soil Density Changes

Corn Tillage/Closing Wheel Study Continued

Four tillage systems were evaluated in the study to evaluate the difference in closing performance.

Vertical-Till (Figure 1.) In the fall after harvest, vertical tillage was used to mix, cut, and level residue in a 3" depth tillage pass. Herbicide was used as a burndown to control early season weeds in the absence of spring tillage.

No-Till: (Figure 2.) Planting directly into last year's corn stalks with no tillage activity performed. Herbicide was used as a burndown to control early season weeds in the absence of tillage.

Conventional-Till (Figure 3.) In the fall after harvest, deep 13" ripping with aggressive cutting and mixing of residue. A spring soil finisher leveled before planting.

Strip-Till (Figure 4.) In the fall after harvest, 10" deep strips were created with a strip-till unit. Herbicide was used as a burndown to control early season weeds in the absence of spring tillage.

Figure 1. Sunflower® 6833 Vertical-Tillage Tool



Figure 2. Planting in No-Till



Figure 3. Sunflower® 4630 Disc-Ripper

Figure 4. Kuhn® Krause Gladiator



Corn Closing Wheel Study Continued

Results:

Conventional: Yield differed by 1.4 Bu/A. between the two closing systems. FurrowForce® proved the positive yield gain, resulting in a revenue gain of +\$7.01/A.

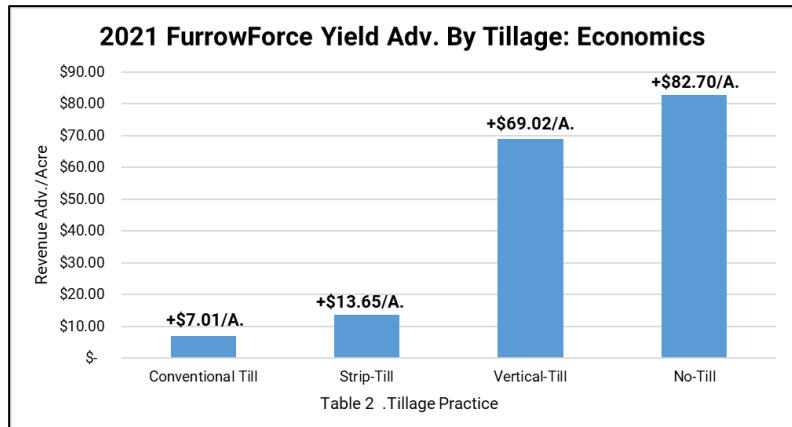
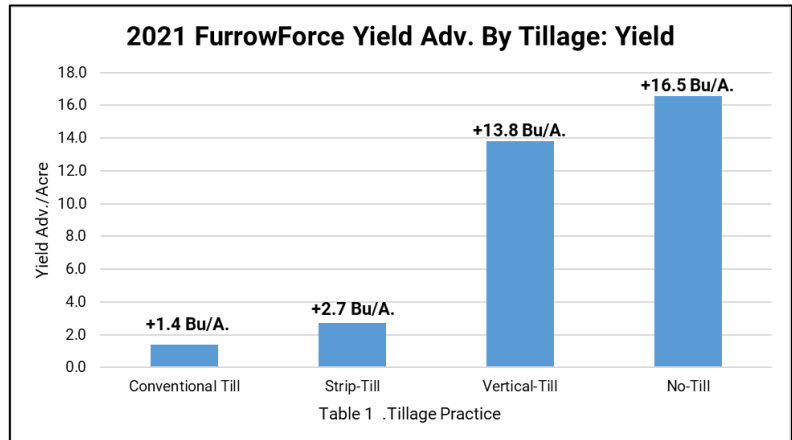
Strip-Till: FurrowForce® proved positive yield gains of +2.7 Bu/A., with revenue gains of +\$13.65/A.

Vertical-Till: FurrowForce® in vertical-till environments proved positive yield gains of +13.8 Bu/A., with associated revenue gains of +\$69.02/A.

No-Till: FurrowForce® proved positive yield gains of +16.5 Bu/A., with revenue gains of +\$82.70/A.

Overall, FurrowForce® two-stage automatic closing resulted in average yield gains of +8.6 Bu/A. and additional revenue of +\$43.09/A. However, the clear advantage came in reduced tillage environments such as no-till and vertical tillage. In these programs, yield gains of +13.8 to +16.5 Bu/A. with increased revenue of +\$69.02 to +\$82.70/A. clearly indicate that in tougher closing situations, a more robust system is needed to effectively close the furrow.

In summary, for years planters have struggled with closing systems with manual settings that offered the inability to account for and change for varying soil conditions. Today, we are excited that technology finally exists where farmers can use sensing technology on the planter row unit to determine how much force is needed on closing systems to address soil variability. By using a robust 2-stage closing system, load pin and sensing architecture, partnered with a 20|20® monitor, farmers can be confident of closing the seed trench, eliminating sidewall compaction/smearing, and removing air pockets all while planting through various seedbed conditions on a pass-pass basis.



DownForce Management Study

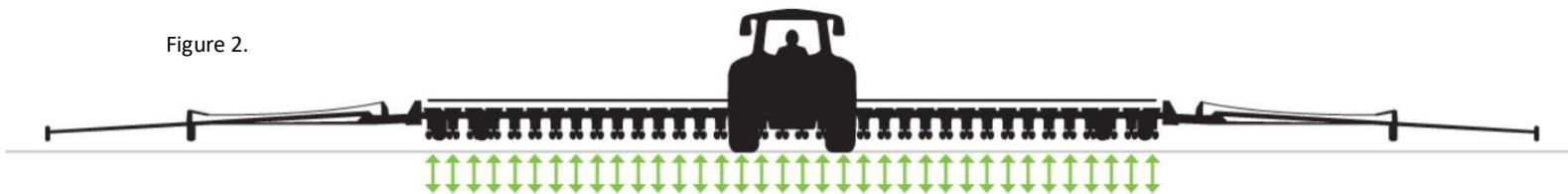
Objective: Planter row unit downforce is a common agronomic issue that often goes unaddressed. This study evaluates yield impact of implementing proper downforce, compared to too light or too heavy row unit settings. When downforce matches field conditions, the depth of planting is consistent and correct. Too light of row unit downforce causes planting depth to shallow up, potentially placing seed in dry soil, thus creating poorly rooted plants that struggle for water and nutrients. Conversely, too much downforce can lead to furrow side-wall compaction also creating an environment that can cause limited plant access to water and nutrients.

DeltaForce® system replaces the springs or air bags on your planter with hydraulic cylinders (Figure 1.) It automatically increases or decreases weight with military precision, on each row individually. When one row encounters conditions different than another (wheel tracks, old roadbeds, clay knobs, headlands, etc.), each will adjust independently (Figure 2). Row by row, foot by foot, and seed by seed, you produce an environment that fosters uniform germination, optimum growth, and maximum yield.

Figure 1. DeltaForce® Cylinder



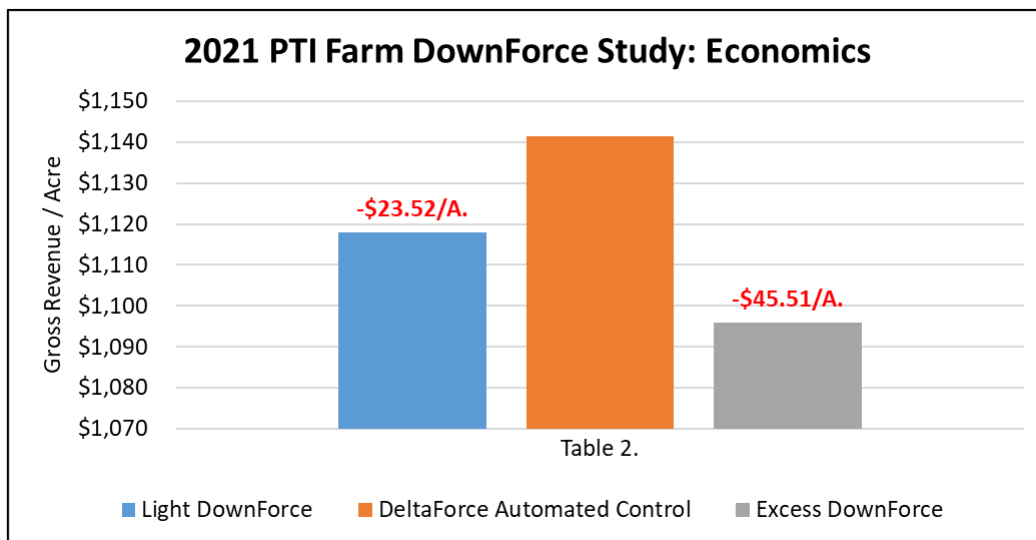
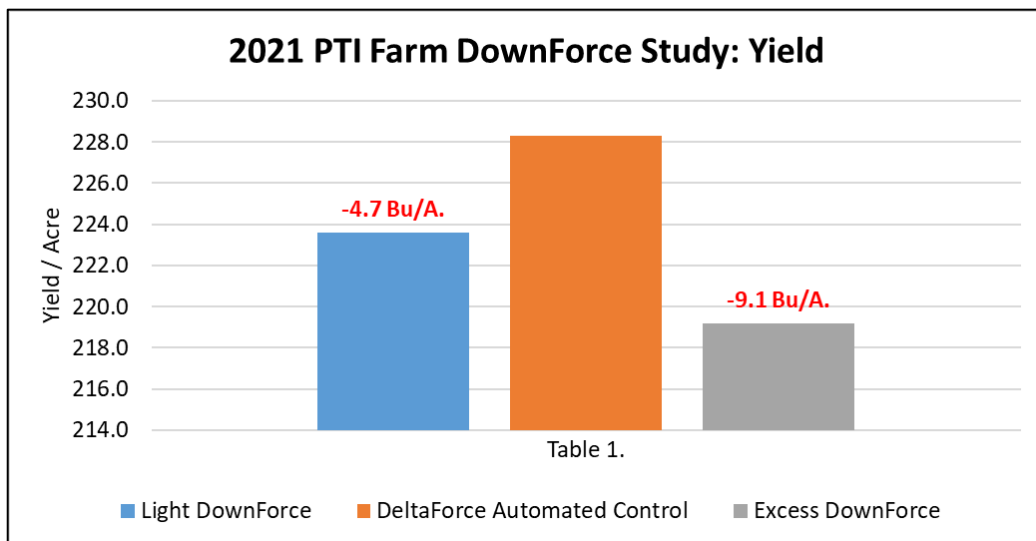
Figure 2.



DownForce Management Study Continued

Results: Table 1. illustrates the yield response of DeltaForce® automated control (Custom 120#) compared to excessive and light downforce settings. Too light of downforce (175# lift, 100# down) resulted in yield decreases of **-4.7 Bu/A.**, while excess downforce (550# down, 100# up) offered the largest yield losses of **-9.1 Bu/A.**

Table 2. reveals the economics of the automated downforce system. Excess downforce suffered the largest overall losses of **-\$45.51/A.**, while too light of downforce resulted in a loss of **-\$23.52/A.**

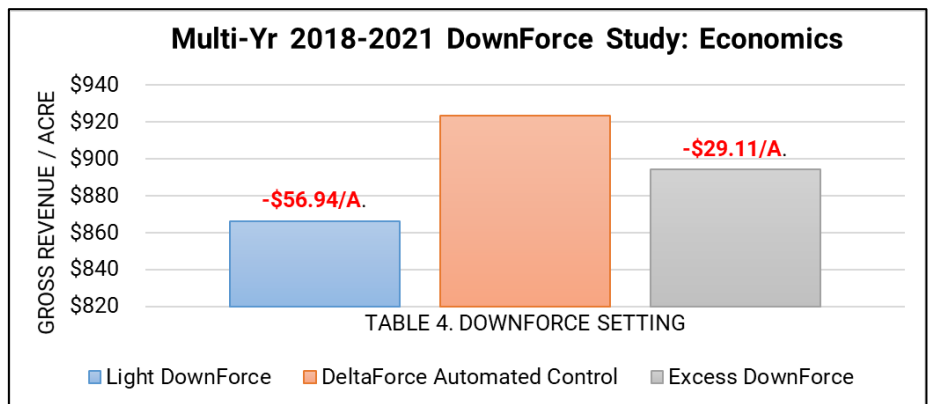
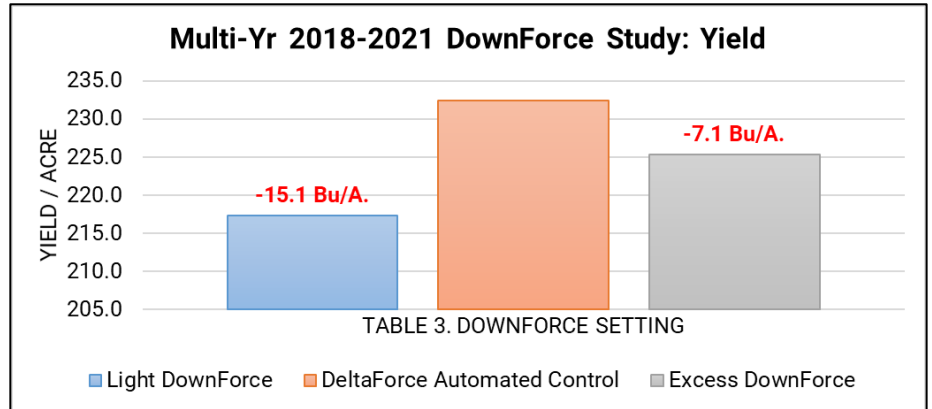


DownForce Management Study Continued

Table 3. illustrates multi-year downforce yield results over the time-period of 2018 to 2021 at the Precision Planting PTI Farm. During these growing seasons, light downforce resulted in yield losses of **-15.1 Bu/A.** compared to automated control with a DeltaForce® system. Excess downforce resulted in losses as well, however at only **-7.1 Bu/A.**

Table 4. depicts the same multi-year time-period, but economics rather than yield. Over 2018-2021, light downforce resulted in economic losses of **-\$56.94/A.** and excess downforce of **-\$29.11/A.**

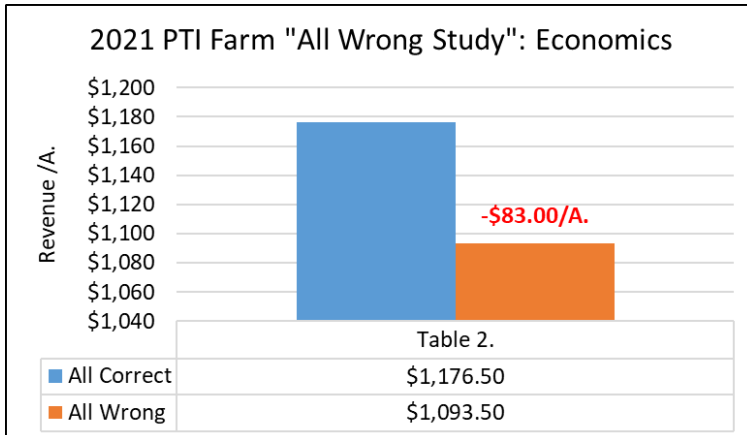
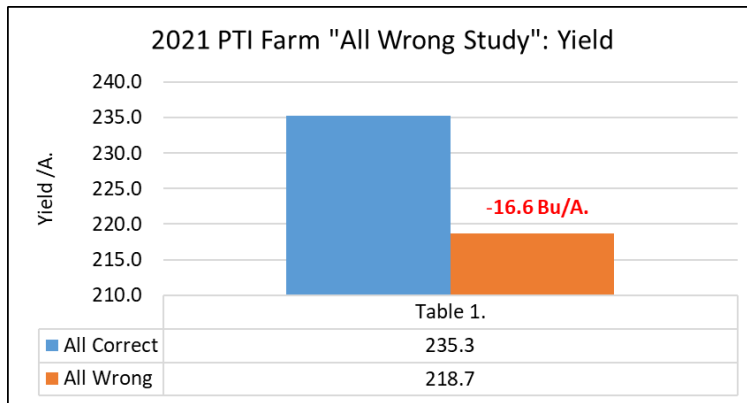
In summary, when downforce matches field conditions, the depth of planting is consistent and correct. By measuring with the DeltaForce® system, farmers can react and take control to ensure proper downforce and eliminate yield and economic losses.



Planter “All Wrong Study”

Objective: This planter trial is designed to simulate yield and economic effects when a grower gets downforce, residue manager settings, and singulation incorrect on the planter, all at the same time. For this study we implemented light downforce, “goof” plates to achieve 95% singulation, and removed the use of residue managers.

Results: Table 1. reveals “All Wrong” planter settings caused yield losses of **-16.6 Bu/A**. Table 2. calculates economic losses of **-\$83.00/A**. when all three planter settings are incorrect. For more information on individual performance of these attributes, please see individual 2021 summary results for down force management, residue management trials, and singulation studies.



Water Management and Recycling Study

Objective: When the Precision Technology Institute was acquired back in the Fall of 2017, we quickly learned that our new research site was a “wet farm”. We learned there was very little field tile to drain our soils to prevent yield losses. Our focus then turned to adding and installing field tile, but problems occurred with that idea as the farm had no good outlet to release the water. Interstate-55 on the west side of the farm, prevents out-letting water through the present road system. To make matters worse, the City of Pontiac resides on the east side of the farm, leaving no good outlet to release water without draining into municipal sewer drains.

Knowing that we ultimately needed to add field tile to our farm to achieve high yields and consistent research trials, we investigated on how to create and sustain our own farm outlet to capture excess water. In the winter of 2018, we began the construction of a new “reservoir” that would be a large body of water designed to act as an outlet for our field tile installed on the farm. This reservoir is nearly 2.5 acres in size and dug near 25’ deep to create enough volume to hold as much water as possible. It was dug on the lowest elevation of the farm, typically where water would stand and remove crops. This size of reservoir was designed as such to act as an outlet for 80 tillable acres. We also chose this design as an 80-acre farm is quite common in size and relatable to most farmers. As we built this system, it was our intention from day one to keep this project practical, realistic, and a system that many farmers could employ on their farms, that could also have drainage issues but no outlet currently.



Figure 1. Drainage Issues at PTI



Figure 2. Digging of “Farm Reservoir”



Figure 3. Farm Reservoir Installation

Water Management and Recycling Study Continued

Once the reservoir was complete, we then began the focus on water capture, an especially important piece to this project. To accomplish this, field tile was installed so that rainwater could be collected from entering the soil profile and filtered through our new field tile drainage system.

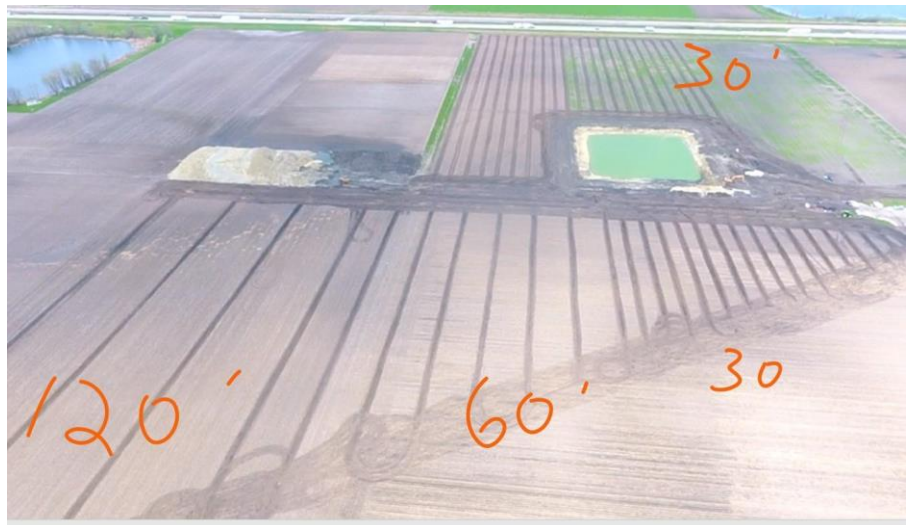
Figure 4. illustrates phase 1 of our project, which included field tile V-Plowed on mostly 30' or 60' patterns, as well as 120' tile to compare agronomic yield and economic returns of various sizes of field tile (Figure 5). It is our intention and desire to monitor this tile performance over the next two decades to understand how tile performs and how long it takes to pay for the system economically.

Water mains were installed around the farm reservoir to collect and direct water from our new tile system into a station designed to “lift” water from the drainage system and deposit water to fill the reservoir.

Figure 4. ADI® V-Plow Tile Installation



Figure 5. 30', 60', 120' Tile Patterns



Water Management and Recycling Study Continued

The water in the farm reservoir is held in place until July and August where it is available to be “recycled” for irrigation purposes (Figure 6). The recycling of rainwater in this project is truly unique and offers sustainability advantages for farmers that have both drainage issues and the lack of water for irrigation of crops.



Figure 6. Completed Farm Reservoir

An important attribute to the PTI Farm’s Water Management Project is the ability to recycle rainwater. Since field tile is collecting and depositing excess rainwater into the reservoir, millions of gallons of water are available to use for irrigation. The crop is fed by delivery from drip tape irrigation. This method of irrigating a crop uses a NETAFIM™ drip tape with small pressure regulated emitters evenly spaced at 24” apart. Drip tape in this study is not sub-surface irrigation, rather the team at PTI installed this system on the soil surface to demonstrate how the system works. Multiple agronomic studies have been implemented as a result of this precious water management in the 2021 Yield Summary Report.



Figure 7. NETAFIM™ Drip Tape



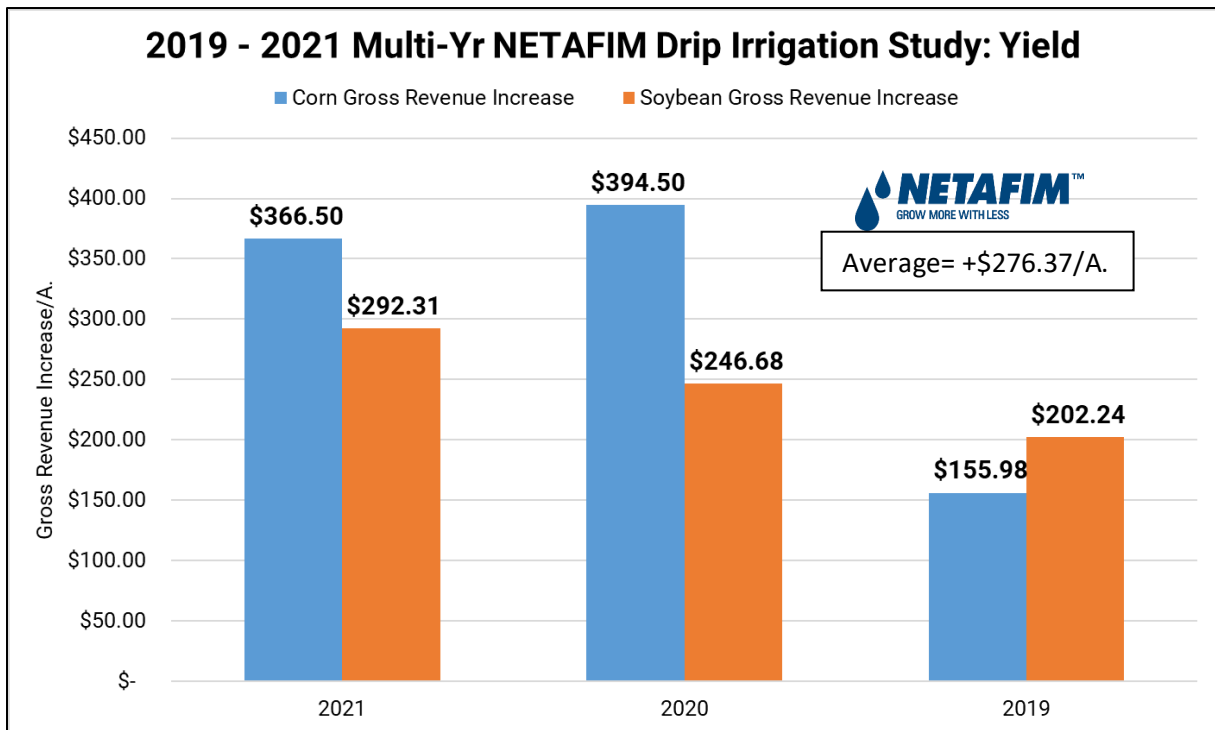
Water Management and Recycling Study

One way to measure the effectiveness of this water management and recycling system is to evaluate corn yield before and after the system was built. Figure 8. summarizes corn yield in a high management trial system through the years 2018 to 2021. High yield trials in 2018 to 2019 resulted in highest yields of 272 Bu/A. to 285 Bu/A. corn, however once the water management system was implement to its fullest capacity, yields improved to 368.2 Bu/A. in 2020 and 357.9 Bu/A. in 2021.

Figure 8. PTI Farm Corn Yield History

Year	Hybrid	Corn Yield
2018	Pioneer 1197	272.5
2019	Dekalb 5356	285.0
2020	DeKalb 63-42	368.2
2021	Golden Harvest 15J91	357.9

The table below puts the ability to irrigate and fertigate into perspective over 2019 to 2021. The ability to recycle rainwater and to mutually fertigate at the same time when needed, has resulted in gross revenue gains averaging +\$276.37/A.



Water Management and Recycling Study

In regard to fertigation, the water management and recycling system does in fact give us the ability to add crop nutrition as we irrigate water to our crops, adding even more potential yield increase.

All water from the farm reservoir is cleaned through a 3-stage sand filtering system that removes any debris or foreign material from the water. This is an important component, as debris could potentially plug emitters that release water on the drip tape, consequently lowering output of irrigation water.

To be efficient as possible, no water is wasted in this scenario. All “dirty water” cleaned from filters is then disposed back into the reservoir for future cleaning once again.

Inside the pump-house resides the sand filters, along with electric pumps, and fertigation meters. Based upon soil tests or plant tissue results, a recipe can be created and then added to irrigation water as it’s sent out to drip lines. Flow meters with-in the system allow the ability to add nutrients very accurately and even in timed applications.

Figure 12. Back-Wash Water to Reservoir



Figure 9. 3-Stage Sand Filtration System



Figure 11. NETAFIM Fertigation System



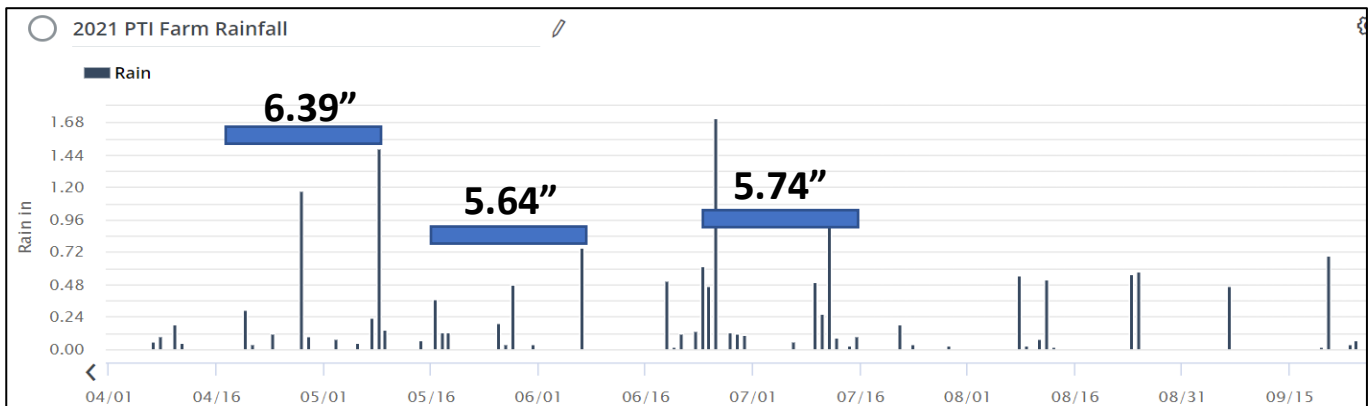
Water Management and Recycling: Tile Study

Objective: To evaluate the performance of 15', 30' and 60' tile patterns. At the PTI Farm we have been annually adding field drainage tile (Figure 1.) at various tile pattern spacing to drain saturated soils, increase soil oxygen levels, and to give the ability to allow earlier planting dates each spring. This study compares the yield performance of three different tile spacings.

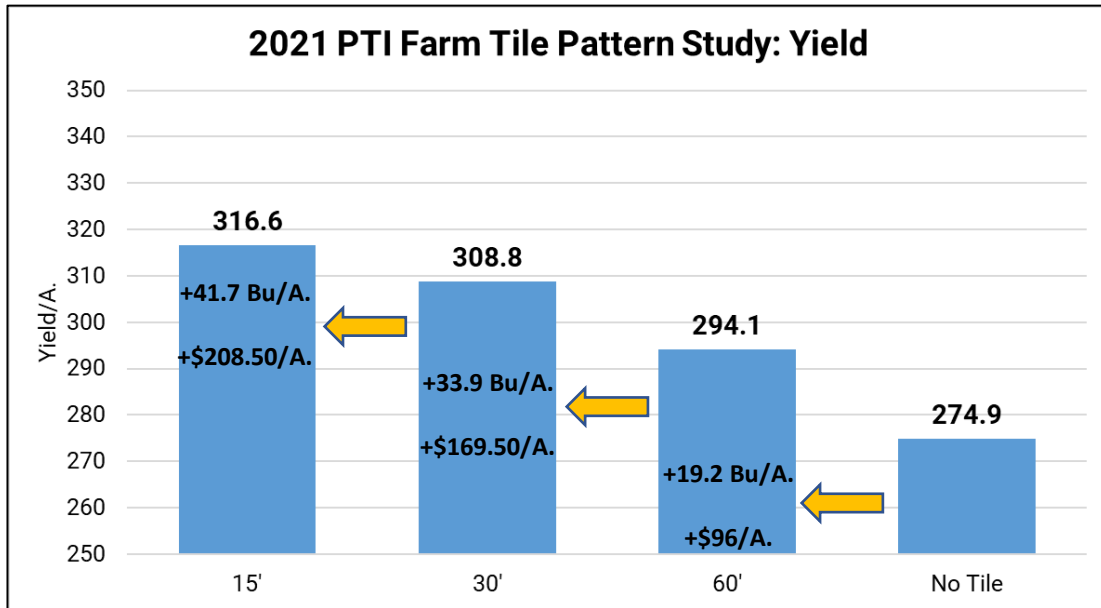
Figure 1. Tile Installation



Rainfall in May, June, and July offered some very large individual rain events that did cause flooding and saturated soils at the PTI Farm. The period around May 1, June 1, and July 1, were three specific timeframes where individual rainfall events surpassed 5" to 6" rainfall totals. Consequently, tile drainage was crucial to get away excess water and to eliminate anaerobic soil conditions.



Water Management and Recycling: Tile Study



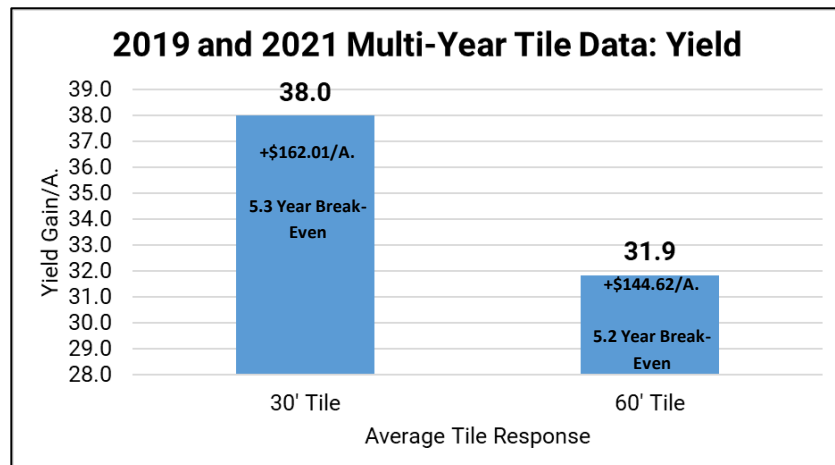
Results:

11. 60' pattern tile resulted in yield gains of +19.2 Bu/A. along with additional gross revenue of +\$96.00/A.

12. 30' pattern tile increased yield gains further by +33.9 Bu/A. with gross revenue of +\$169.50/A.

13. 15' pattern tile increased yield by +41.7 Bu/A., obtaining highest gross revenues of +\$208.50/A.

14. Multi-year data indicates near 5 year break-even for tile installed in spring 2019.



Water Management and Recycling: Tile Irrigation Study

Objective: To evaluate the performance of using field tile as a form of irrigation. Normally, field tile is used to drain saturated soils (Figure 1.) However, in this study we installed 15' and 30' 3" black plastic field tile to compare its ability to not only drain water, but to also back-feed irrigation water back through the field tile to offer irrigation to a growing crop.

Figure 2. shows the layout of our pattern tiled field installed in the early spring of 2021. Both 15' and 30' pattern tile widths were used to understand the difference in the soil's capillary action or uptake of water. This study is one of many at the PTI Farm designed as long-term 10+ year studies to study consistency and longevity of the system.

Figure 1. Tile Installation



Figure 2. 15' and 30' Pattern Tile Installation



Water Management and Recycling: Tile Irrigation Study

Figure 3. is a photo of our gate system that gives the ability to control the water table. Gates can be added or removed to allow water to back-feed or “fill up” the tile, which in turn draws water up into the soil profile. Water is sourced and pumped out of our water recycling reservoir to back feed the water through the tile system in the field.

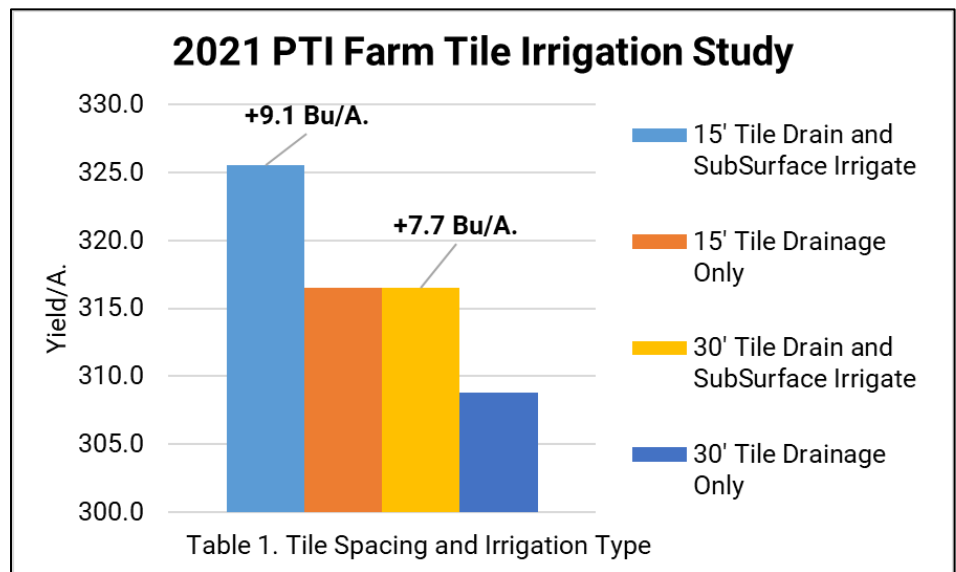


Figure 3. Gate Structures to Control Water Table

Results: Back-feeding water through tile gained +7.7 Bu/A. in 30’ tile pattern tile and +9.1 Bu/A. yield gains in 15’ tile patterns.

It should be noted that for this first year of testing (2021), NETAFIM drip tape was used as the primary irrigation source for all treatments and the back-feeding of water for secondary irrigation. We did this for two reasons:

- Back-Feeding of water in tile does not allow the use of fertigation. Applying nutrients such as N, P, or K could contaminate water supply, so tile is used for water irrigation only. The NETAFIM drip tape is used for additional water as well as fertigation.



- In the fall of 2021 after harvest, permanent NETAFIM was installed in zones by tile pattern to allow the ability to use drip tape for fertigation alone, and the 15’ and 30’ tile patterns for irrigation water only. This system will be in full use in 2022 to separate the two irrigation and fertigation systems.

2021 PTI Farm High Management Corn Yield Study

Objective: In 2021 we took the opportunity to use the water management and recycling system at the PTI Farm to act as host to one of our many high yield management trials on the farm. Our goal was to learn how to implement high yielding programs and what it takes to drive corn yield, knowing that we would have sufficient drainage and ample irrigation water throughout the growing season.

The following recipe was our protocol to achieve high corn yield:

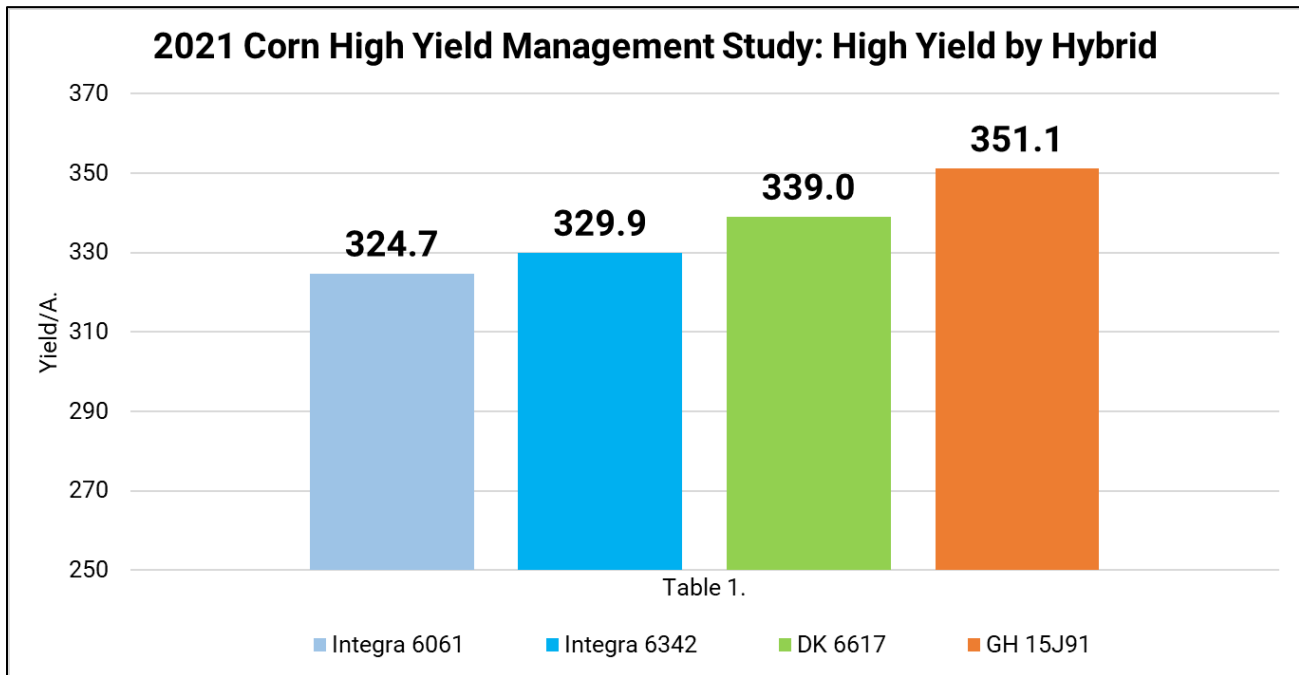
Figure 1. 2021 High Yield Protocol

<p>FurrowJet® Center: At-Plant</p> <ul style="list-style-type: none"> • 2 Gal/A. Nachurs® First Down™ • 1 Qt/A. Nachurs FaceOff® • 2 Gal/A Water 	<p>FurrowJet® Wing: At-Plant</p> <ul style="list-style-type: none"> • 4 Gal/A. Nachurs First Down™ • 1Qt/A. Nachurs Humi-Flex® • 2 Gal/A. Water 	<p>Conceal® Dual Band: At-Plant</p> <ul style="list-style-type: none"> • 3 Gal/A. Nachurs K-Fuse • 3 Gal/A. Nachurs Throwback® • 1 Gal/A. Nachurs SideSwipe® • 27 Gal/A. UAN 32%
<p>V4 Side-Dress</p> <ul style="list-style-type: none"> • 30 Gal/A. 32% UAN • 2 Gal/A. Nachurs K-Flex® Max • 1 Gal/A. SideSwipe® 	<p>Foliar: V3</p> <ul style="list-style-type: none"> • 1Qt/A. Nachurs Finish Line® • 2Gal/A. Nachurs Triple Option® • 1pt/A. Humi-Flex® FA 	<p>Foliar: V10</p> <ul style="list-style-type: none"> • 1 Gal/A. Nachurs K-Fuel® • 1 Qt/A. Nachurs Finish Line® • 5oz FMC TopGuard® Fungicide
<p>V10-V12 Fertigation</p> <ul style="list-style-type: none"> • 10 Gal/A. 32% UAN • 4 Gal/A. Nachurs K-Fuel® 	<p>V12-Tassel Fertigation</p> <ul style="list-style-type: none"> • 7.5 Gal/A. 32% UAN • 1 Gal/A. Nachurs SideSwipe® 	<p>After Tassel Fertigation</p> <ul style="list-style-type: none"> • 7.5 Gal/A. 32% UAN
<p>Foliar: VT</p> <ul style="list-style-type: none"> • 13.7oz/A. Miravis® Neo Syngenta • 1 Gal/A. Nachurs First Down™ • 1 Gal/A. Nachurs Balance® 		<p>Foliar: R2</p> <ul style="list-style-type: none"> • 13.7oz/A. TrivaPro® Syngenta • 2 Gal/A. QLF® Amino-15 • 3 Gal/A. Nachurs Aqua-Tech® 7-20-4



2021 PTI Farm High Management Corn Yield Study

Four corn hybrids were planted in this high management yield study, including Dekalb 66-17, Golden Harvest 15J91, Integra 6342, and Integra 6061. Table 1. illustrates the high yield for all four corn hybrids in the high management corn study. Golden Harvest 15J91 took top honors at 351.1 Bu/A., DeKalb 66-17 at 339 Bu/A., Integra 6342 at 329.9 Bu/A. and Integra 6061 at 324.7 Bu/A.



351.1 Bu/A.



2021 PTI Farm High Management Corn Yield Study

Table 2. illustrates corn yield divided by seeding rates for each hybrid. All hybrids averaged 9.34 Bu/A./1000 seeding rates. Golden Harvest 15J91 proved a 9.75 ratio, the highest of all four corn hybrids.

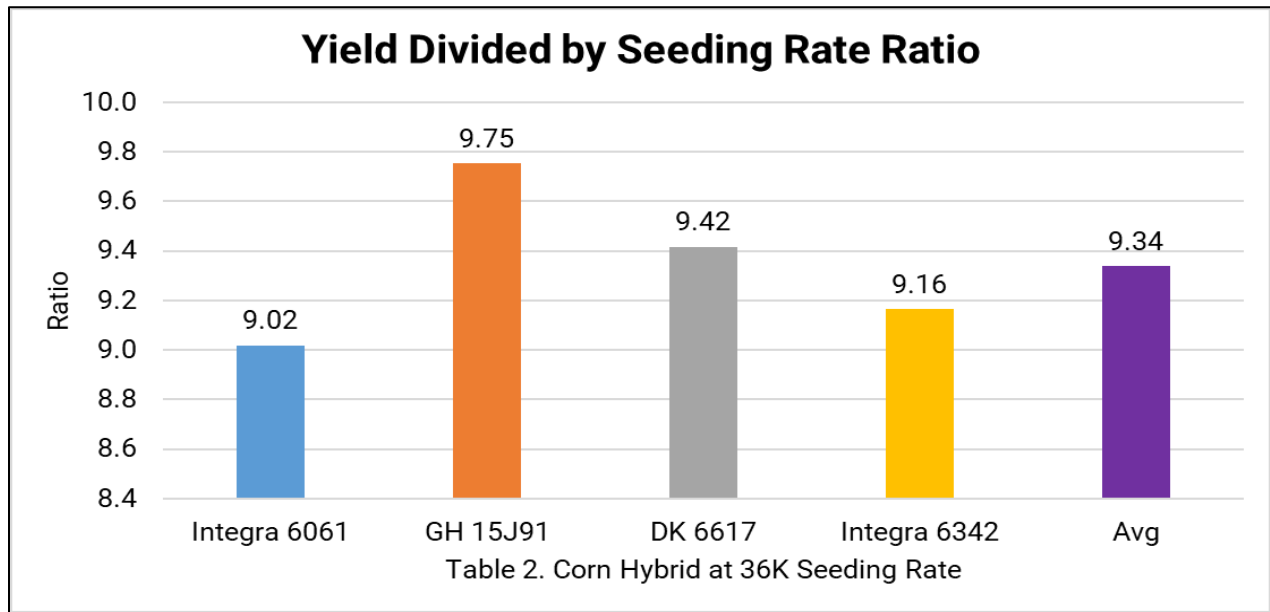
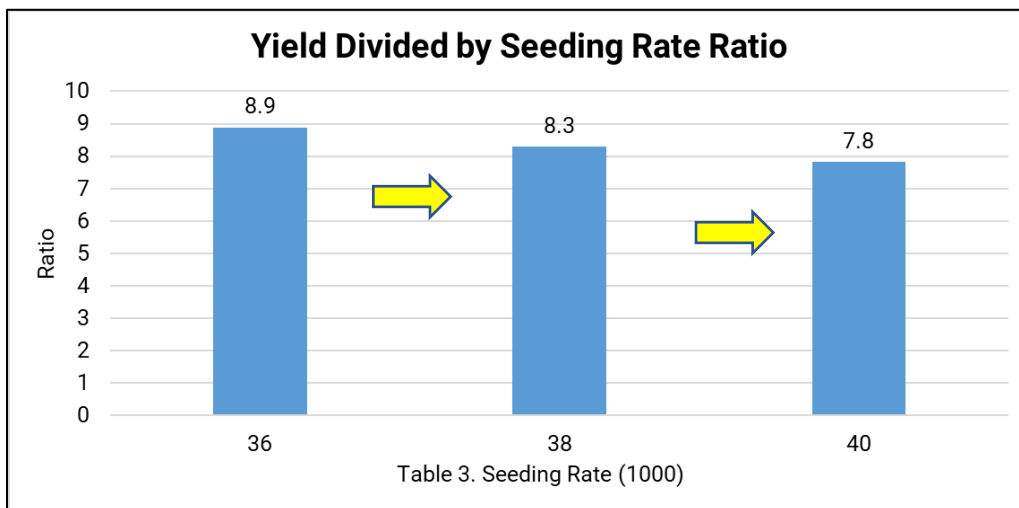


Table 3. illustrates average yield to seeding rate ratio for each seeding rate of 36K, 38K and 40K populations. In 2021, increased seeding rates did not equate to additional yields. In fact, yield to seeding ratios decreased at a rate of 0.5 at each seeding rate increase at 38K and to 40K.

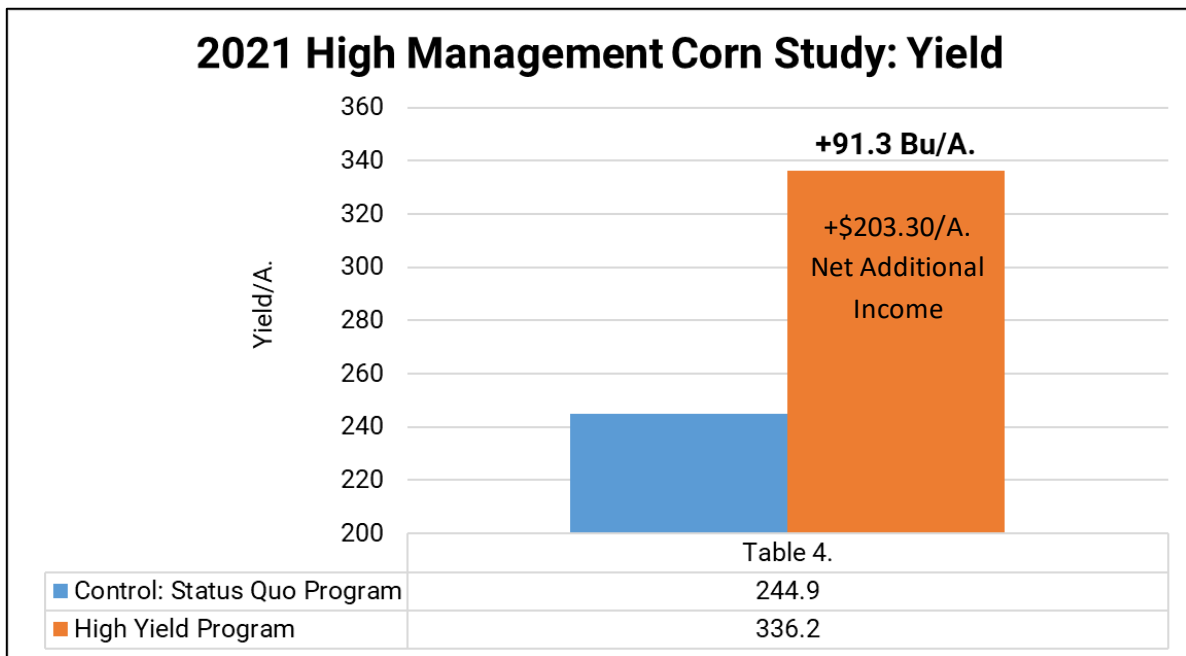


2021 PTI Farm High Management Corn Yield Study

Table 4. summarizes the overall yield response of the PTI Farm High Management program (listed in Figure 1. earlier) compared to a “Status Quo” program that is not intensively managed. The High Management Program resulted in additional yield gains of +91.3 Bu./A. and the exciting endeavor of this program is the financial aspects. Additional input costs of the high yield program tallied an extra +\$253.20/A., however the additional yield gains outweighed these costs by +\$203.30/A.

The status quo program consisted of the following:

- No Field Tile Drainage
- No Irrigation
- 150# 18-46-0 + 125# 0-0-60
- 180# Nitrogen Program (25% WNF+25% Conceal®+50% Side-Dress) with all N blended to a 7:1 nitrogen: sulfur blend.
- 6 Gal FirstDown™ Starter Fertilizer Program Applied via FurrowJet® Tri-Band
- 3 Gal K-Fuse Starter Program Applied via Dual Band Conceal®
- 2 Gal TripleOption, 1Qt FinishLine Post V3 Foliar 5oz TopGuard® Fungicide applied at VT



2021 PTI Farm High Management Corn Yield Study

As a new technology in the marketplace, many foliar treatments in the PTI Farm High Management Study included the use of a Rantizo spray un-manned ag vehicle (UAV) (Figure 2.) In our 1st year of evaluating spray UAV applications, it does appear that this technology is an effective method to apply crop protection products. Advantages to this technology include precise application due to downward propeller air movement, low carrier rates, the absence of ground or soil engagement, and the ability to spray in fields with topography challenges.

Additional studies with this exciting technology is available throughout the 2021 PTI Farm Yield Summary Report.

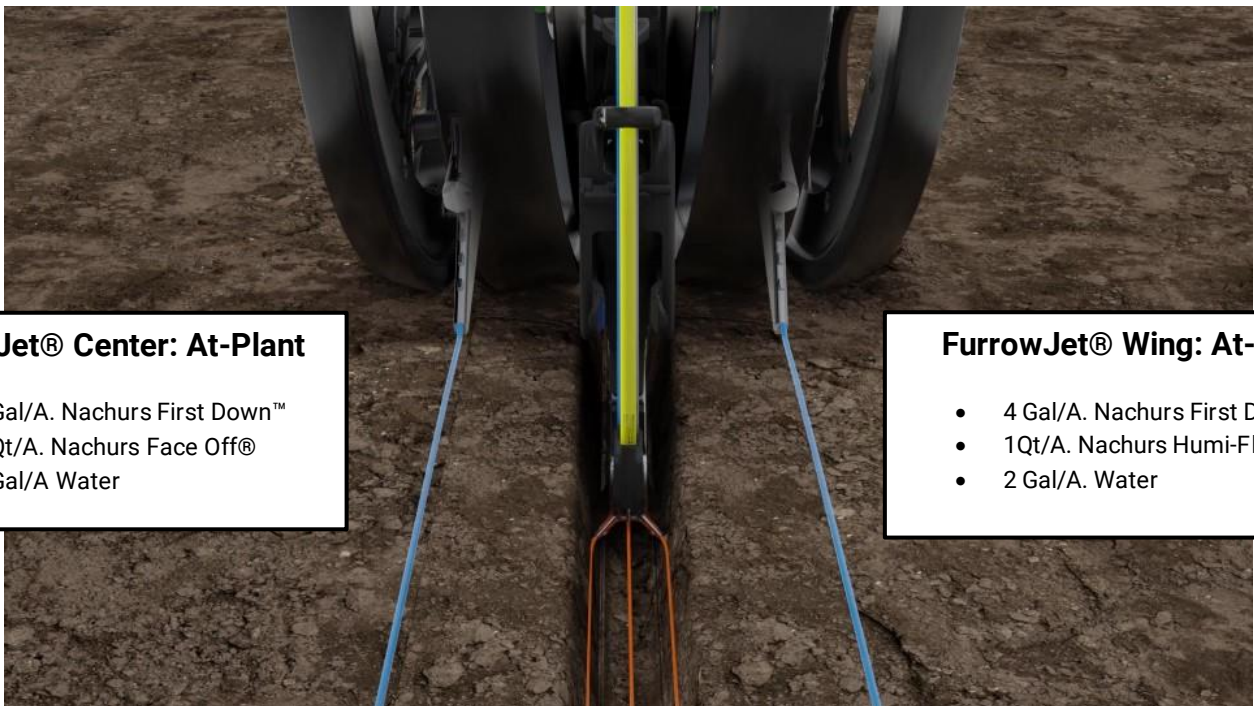


Figure 2. Rantizo Spray UAV

High Management Corn Nachurs® Planter Fertilizer Study

Objective: In this high yield management trial, our goal was to learn how to implement high yielding programs and what it takes to drive corn yield using FurrowJet® and Conceal® at-plant fertilizer treatments. This high yield study utilizes the water management and recycling system at the PTI Farm and uses intensive tile drainage as well as NetAFim NutraDip irrigation.

Three at-plant treatments, as well as a combination application are evaluated in this study and exists of the following Nachurs crop nutrition products:



FurrowJet® Center: At-Plant

- 2 Gal/A. Nachurs First Down™
- 1 Qt/A. Nachurs Face Off®
- 2 Gal/A Water

FurrowJet® Wing: At-Plant

- 4 Gal/A. Nachurs First Down™
- 1Qt/A. Nachurs Humi-Flex® Max
- 2 Gal/A. Water

Conceal® Dual Band: At-Plant

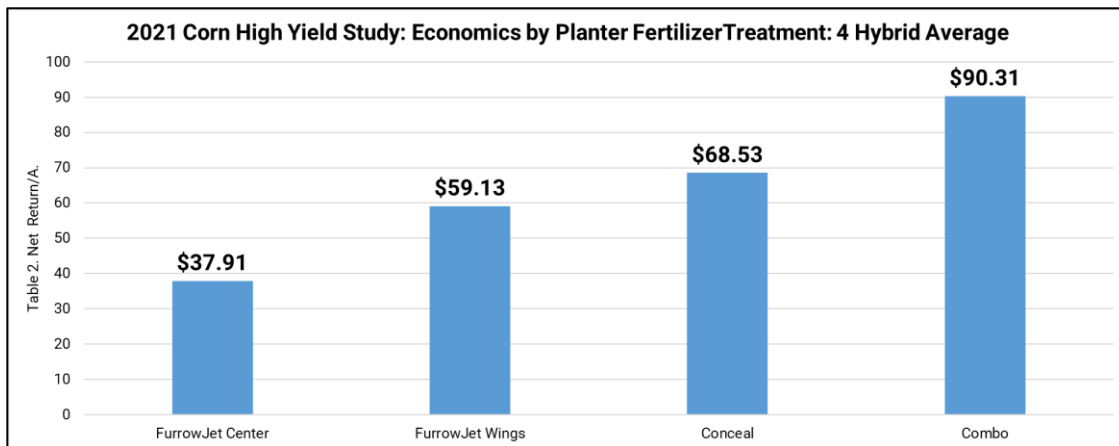
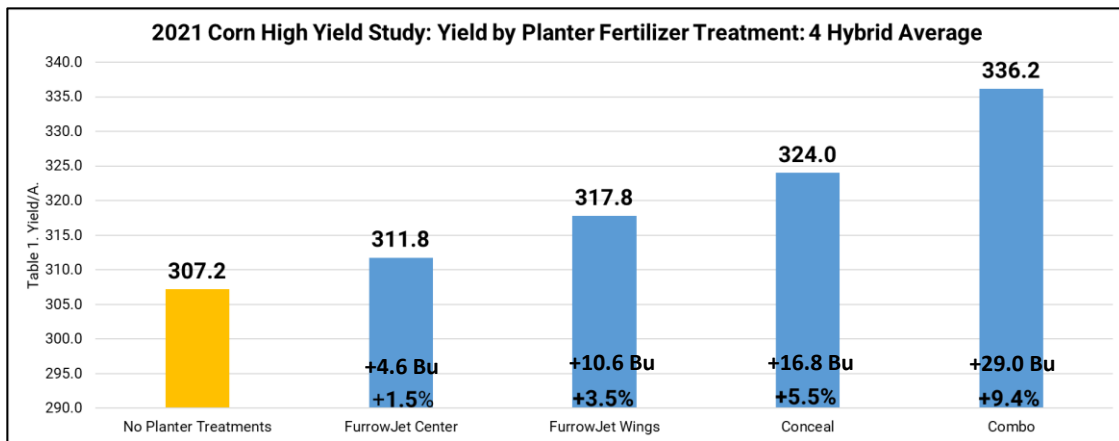
- 3 Gal/A. Nachurs K-Fuse
- 3 Gal/A. Nachurs Throwback®
- 1 Gal/A. Nachurs SideSwipe®
- 27 Gal/A. UAN 32%



High Management Corn Nachurs® Planter Fertilizer Study

Results: Four corn hybrids were planted in this high management yield study, including Dekalb 66-17, Golden Harvest 15J91, Integra 6342, and Integra 6061. Table 1. illustrates corn yield at each fertilizer placement. The highest overall yield received was from 3-way combination treatments at 336.2 Bu/A, representing at +9.4% yield increase (+29.0 Bu/A.) Individual contribution included Conceal® treatments proving +5.5% yield improvements at 324 Bu/A. (+16.8 Bu/A.), FurrowJet® wings adding +3.5% yield gain at 317.8 Bu/A. (+10.6 Bu/A.), and FurrowJet® centers at +1.5% yield gain at 311.8 Bu/A. (+4.6 Bu/A.)

Table 2. summarizes net return of all planter fertilizer treatments. All treatments incurred positive gains with averages of +\$37.91/A. to +\$90.31/A.

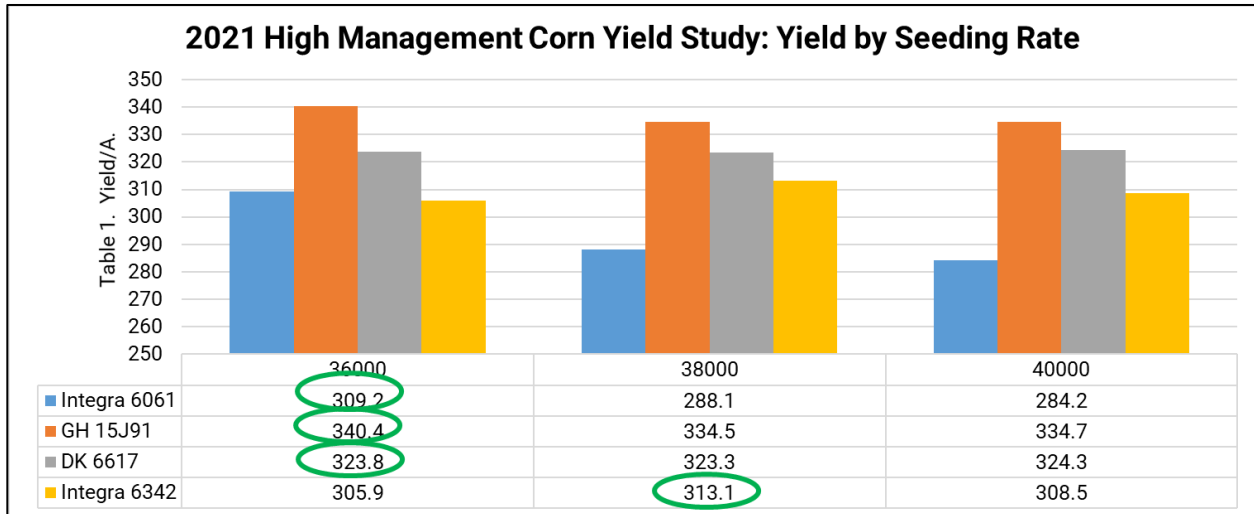


Planting Date: April 24 Hybrid: Integra 6061, 6342, DKC 6617, GH 15J91 Population: 36,38,40K Row Width: 30" Rotation: CAB Corn Price: \$5.00

Firstdown: \$4.92/Gal FaceOff: \$21/Gal. Humi-FlexMax: \$17.28/Gal. KFuse: \$4.80/Gal. Throwback: \$5.10/Gal. SideSwipe: \$15.90/Gal

High Management Corn 30" Row Seeding Rate Study

Objective: This study evaluates yield and economic impact of four corn hybrids including Dekalb 66-17, Golden Harvest 15J91, Integra 6342, and Integra 6061 at seeding rates of 36K, 38K, and 40K in 30" rows.



Results: Three of the four corn hybrids offered highest yield at the 36K seeding rate. Integra 6342 deviated from this with 38K seeding rates providing a 7.2 Bu/A. yield increase or +2.4% compared to 36K. The green circles on table 1. illustrate the highest yield for each corn hybrid.

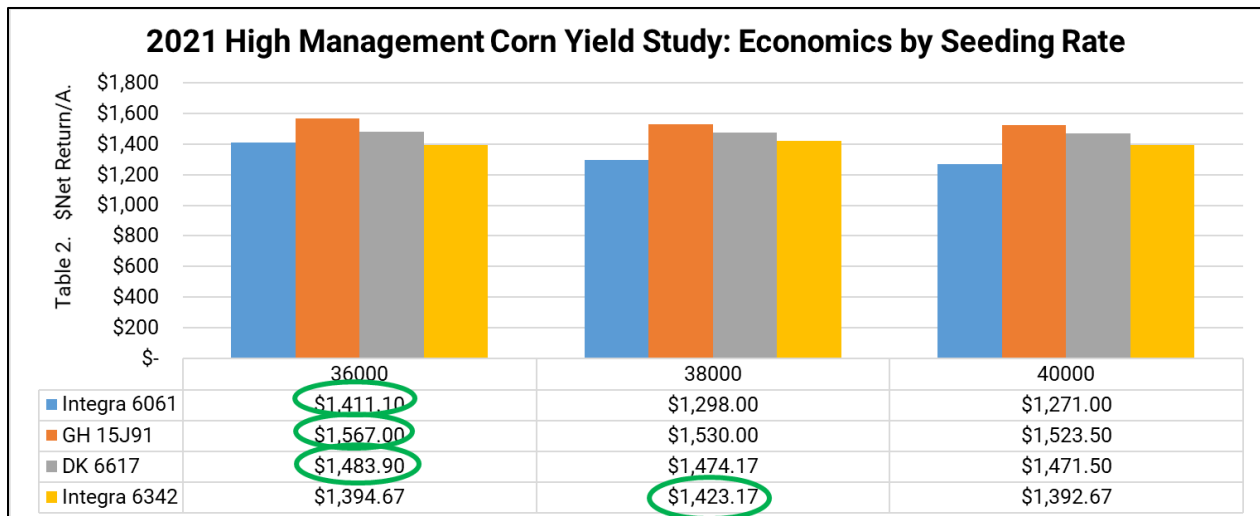
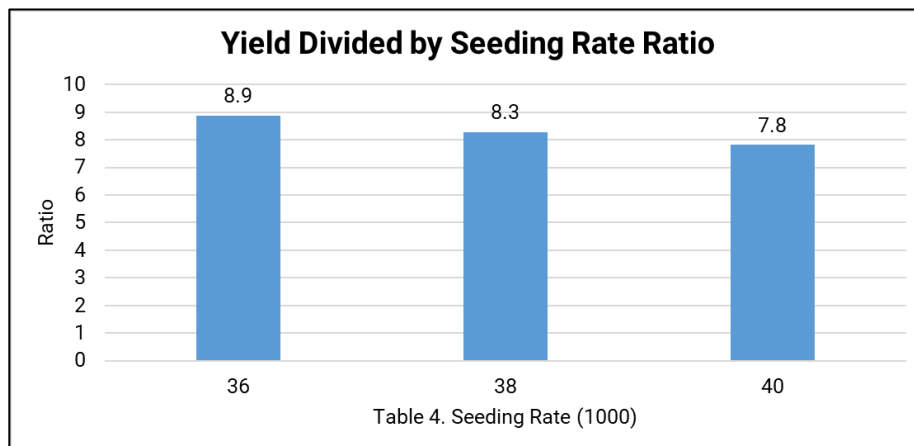
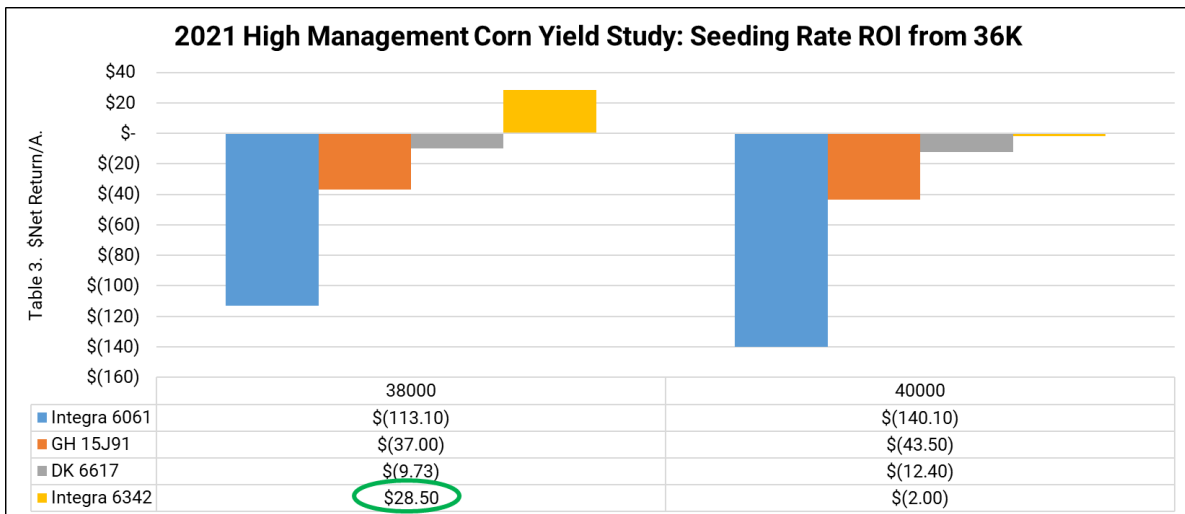


Table 2. illustrates economic optimum seeding rate after cost of seed. Only Integra 6342 benefitted from increasing seeding rate higher than 36K with a 38K optimum rate.

High Management Corn Seeding Rate Study Continued

Table 3. illustrates the economic response for each of the four corn hybrids when seeding rates were increased past 36K to 38K and 40K seeding population:

- ✓ Integra 6061 demonstrated losses of **-\$113.10** at 38K to **-\$140.10/A** at 40K.
- ✓ Golden Harvest 15J91 proved losses of **-\$37.00** at 38K to **-\$43.50/A.** at 40K.
- ✓ DeKalb 66-17 proved losses of **-\$9.73** at 38K to **-\$12.40/A.** at 40K.
- ✓ Integra 6342 offered gains of **+\$28.50** at 38k, while losses of **-\$2.00/A.** at 40K
- ✓ Average Yield to Seeding Rate Ratios = 8.9, 8.3 and 7.8 respectively (Table 3.)



High Management Corn Ocean Blue Ag Fertility Study

Objective: To evaluate the yield and economics of Ocean Blue Ag's corn nutrition program. This high management fertility study implements the use pre-plant dry calcium, at-plant FurrowJet® and Conceal® liquid nutrition, as well as foliar liquid applications at V3, VT, and R1 growth stages in a high yield, irrigation corn/soybean rotation.

SandyCal by Calcean, is applied as a broadcast pre-plant and is raw natural aragonite sand that is 94-98% pure calcium carbonate.

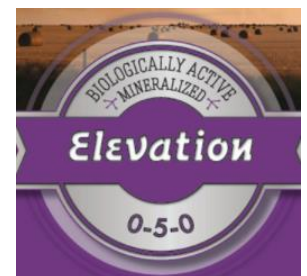
Elevation 0-5-0 is an early V3 foliar feed that contains long lasting bio-stimulated catalyst and phosphoric acid that helps pollination, blossom retention and fruiting.

Grain Gain 0-5-0 is a VT foliar feed that is a reproductive energizer and catalyst that improve test weight, insect and disease resistance and better grain fill.

Nutri-Shield 0-7-0 is applied in-furrow and contains vitamin hormone enzymes, rooting acids, chelated trace minerals, and humic acids. It helps provide for immediate growth energy, promotes stronger roots and suppresses insect feeding.

Power Pro N 7-0-0 S-8 Ca-3 is applied as a tank-mix with 32% UAN at side-dress and is a soil nutrient enhancer and natural nitrogen stabilizer that revives soil microbiology, and improves nitrogen efficiency.

Hydron is a liquid foliar product made from anhydrous ammonia mixed with water.



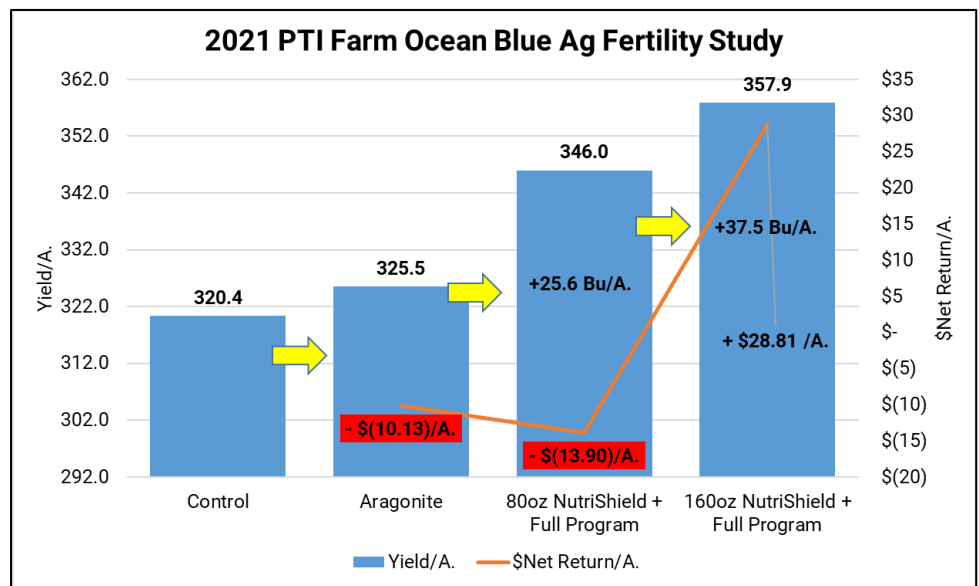
Ocean Blue Ag Fertility High Management Study

Product	Application Timing	Placement of Fertilizer
750# Aragonite	Pre-Plant	Broadcast Spinner
80oz NutriShield	At-Plant In-Furrow	FurrowJet® Tri-Band
160oz NutriShield	At-Plant In-Furrow	FurrowJet® Tri-Band
6 Gal PowerPro	Side-Dress N	Center Knife w/Sealer
64oz Elevation	V3	Foliar Broadcast Spray
1 Gal GrainGain	VT	Foliar Broadcast Spray
64oz Hydron	VT and R1	Foliar Broadcast Spray

Results: The table above represents all individual treatments in this high yield study. NutriShield was evaluated as 80oz and 160oz program in-furrow programs in conjunction with Aragonite and all treatments.

Aragonite treatments alone resulted in +5.1 Bu/A. gains, however, failed to provide economic gains with losses of **-\$10.13/A.**

160oz of NutriShield in-furrow, along with all other treatments resulted in excellent yields of 357.9 Bu./A., proving +37.5 Bu/A. over the untreated control. Financially, this treatment resulted in economic gains of +\$28.81/A.



Reducing NutriShield to 80oz/A. in-furrow, reduced yield by **-11.9 Bu/A.** and resulted in economic losses of **-\$42.72/A.**

Planting Date: April 24 Hybrid: GH 15J91, DK66-17, Integra 6061, 6342 Population: 38K Row Width: 30" Rotation: CAB Corn Price: \$5.00

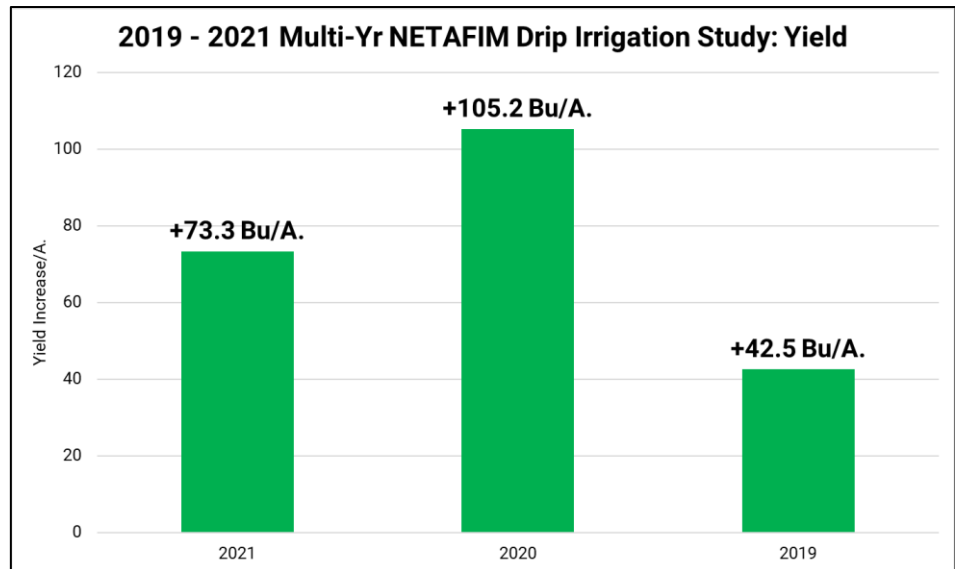
Foliar Apps: \$12/A. Aragonite: \$159 + \$6 App PowerPro: \$5.38/Gal NutriShield: \$26.88/Gal Grain Gain: \$19.95/A. Elevation: \$26.88/A. Hydron: \$11.80/Gal

High Management Corn NETAFIM™ Irrigation Study

Objective: This study evaluates NETAFIM drip tape irrigation designed by NutraDrip Irrigation Systems, and its' ability to feed corn with water and nutrients for high yield potential. This method of irrigating a crop uses NETAFIM drip tape with small pressure regulated emitters evenly spaced at 24" apart. Drip tape in this study is not sub-surface irrigation. It is rather installed on the soil surface to demonstrate how the system works to growers who come to visit the PTI Farm. Water is accessed from a water recycling management program installed at the PTI Farm.



Results: In 2021, NETAFIM drip tape irrigation resulted in average corn yields of 310.4 to 357.9 Bu/A., an average of +73.3 Bu/A. increase over the non-irrigated control. 5" of rain was applied through drip irrigation throughout the growing season from June - September. Fertigation was also implemented to apply N, B, Cu, S, P, and K.



Multi-Year data has proven to increase corn yield by an average of +73.7 Bu/A., while increasing additional gross income by an average of +\$305.66/A.



mSet® Multi-Genetic Planting Study

Objective: To analyze the yield and economic benefit of implementing mSet® single meter multi-genetic technology to place specific corn hybrids for individual spatial management zones.

mSet® is an upgradeable product to vSet® meters and vDrive® controller, which couples a seed selector added to the hopper to switch hybrids, and a seed pool level sensor in the meter (Figure 1.) The level sensor tells the seed selector when the meter needs more seed, and it drops a dose of seed into the meter. This continually happens until it is time to switch hybrids. At hybrid change, the level sensor will let the seed pool run low, then call for a dose of the other hybrid to enter the meter just in time for the change, leading to a short transition between hybrids. The seed pool is controlled by the mSet® selector (Figure 2.), providing the correct hybrid in the meter, and allowing the vSet® meter to accurately singulate those seeds. The ultimate result is the hybrid you select, planted in the area of the field you select, planted with highest accuracy of singulation. Additionally, for those who want to both; plant fast, and place hybrids by spatial zone variability, SpeedTube® system can be used in tandem with multi-genetic technology (Figure 3).

Figure 1. mSet® Box



Figure 3. Speedtube®

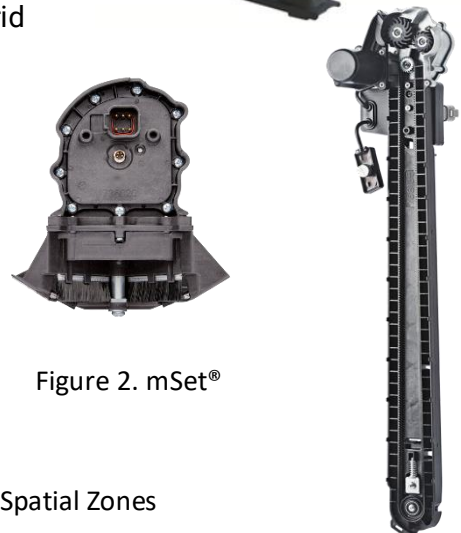
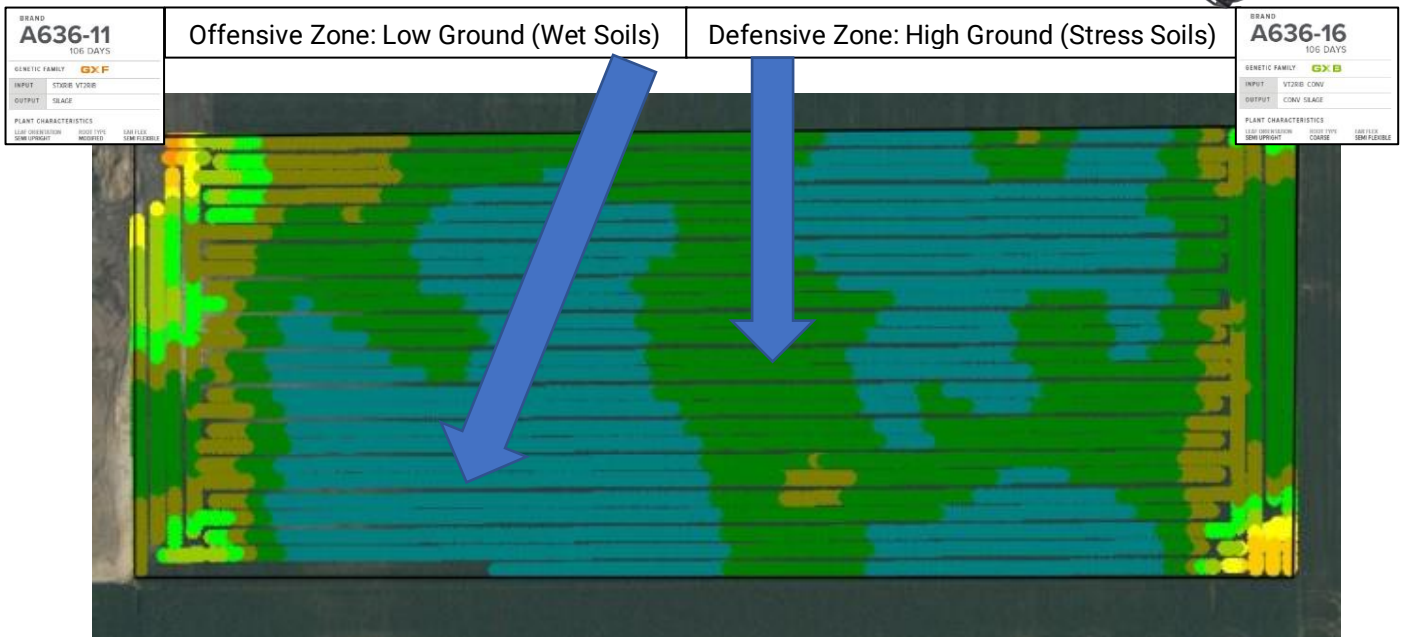


Figure 2. mSet®



Figure 4. Offensive and Defensive Spatial Zones



Multi-Genetic Planting Study Continued

Results: AgriGold 636-11VT2RIB was used as our offensive corn hybrid in the lower elevation, higher OM, but potentially saturated soils. AgriGold 636-16VT2RIB was used as the defensive hybrid planted into the higher ground, lower OM, and potentially droughty soils. Each genetic package was placed into the appropriate matching spatial management zone (Figure 4). Test blocks were planted to evaluate the yield performance when hybrids were placed correctly, as well as incorrectly.

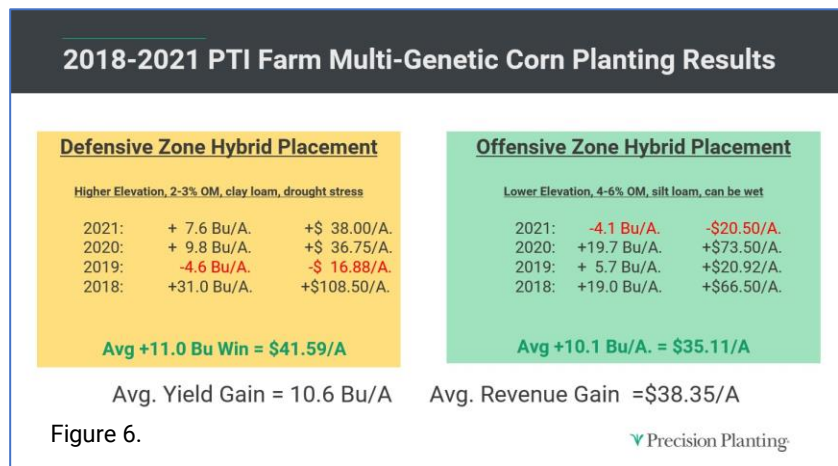
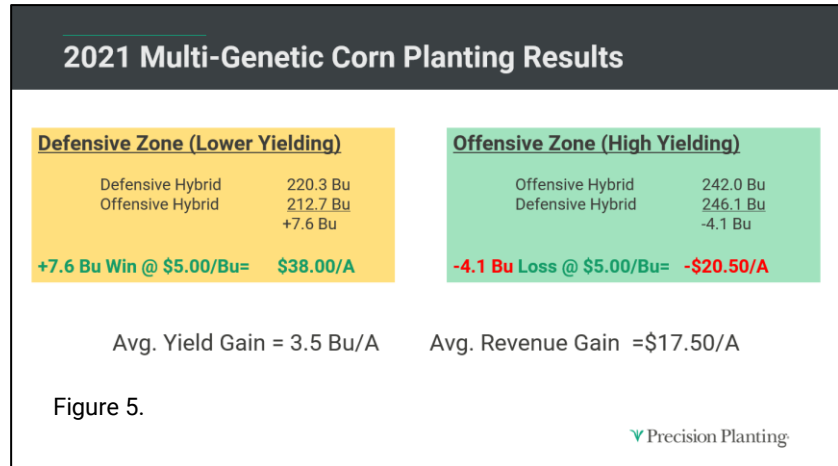
Figure 5. illustrates the 2021 multi-genetic planting results. Correct placement in the defensive zone resulted in yield gains of +7.6 Bu/A. and corresponded to an economic advantage of +\$38.00/A.

Figure 5. also illustrates that the correct hybrid placement in the offensive zone resulted in yield losses of **-4.1 Bu/A.** and decreased revenue of **-\$20.50/A.**

Figure 6. summarizes multi-genetic corn planting performance over the four-year time period of 2018-2021. During this timeframe, multi-genetic corn has offered increased yield gains of +10.6 Bu/A. with additional farm

revenue of +\$38.35/A. in increased revenue. In each zone placement over the last 4 years, only once was the placement incorrect. This track record would suggest a 75% success rate for multi-genetic planting over 2018-2021 for each high/low yield zone.

Based on this data, if a grower invested \$1000/row on a 16-row planter for multi-hybrid technology, these types of yield and economic gains would result in return on investment at only 417 acres. These yield results confirm that a multi-genetic system can offer yield advantages and potentially large economic gains if used properly. For this system to work, growers and seedsperson need to work together to place the appropriate genetics on the correct acre and planted at suitable seeding rates.



Force® 6.5G vDrive® Insecticide Study

Objective: This trial evaluates the yield and net return of Force 6.5G soil applied insecticide. Force 6.5G soil-applied corn insecticide is a higher-load (2lbs/A.) granular formulation for control of corn rootworm and other soil-dwelling insect pests. This formulation was developed by Syngenta to better meet the changing needs of today's corn growers who are looking for both superior performance and increased at-plant efficiency. Four Golden Harvest corn hybrids were tested in this study to evaluate the yield and net return at a full rate of Force 6.5G.

Results: Table 1. reports Force 6.5G applications resulted in average yield gains of +7.6 Bu/A., ranging from +5.5 Bu/A. to +11.5Bu/A. over the four corn hybrids tested. Yield response needed for break-even was +5.00 Bu/A.

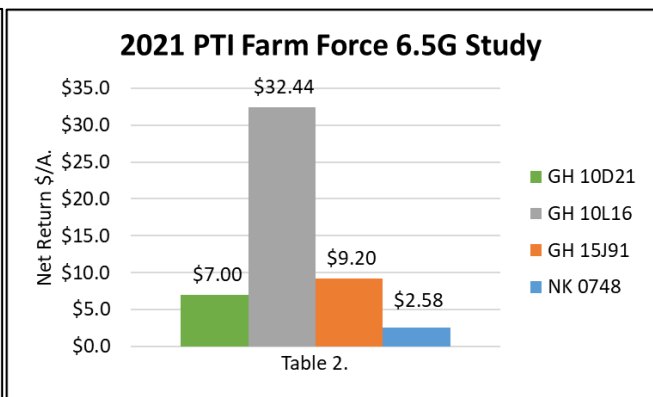
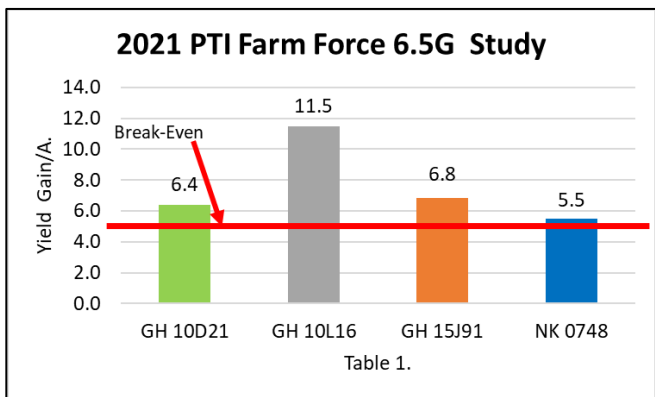
Table 2. illustrates that all four corn hybrids proved economic gains from using Force 6.5G. GH10L16 proved highest individual returns at +\$32.44/A.

As corn rootworm (*Diabrotica virgifera*) continues to be a major insect threat to corn yield, solutions like granular insecticides on the planter are an excellent tool in the toolbox for accurate placement and protection.

Figure 1. Force® 6.5G Label



Figure 2. vDrive® Insecticide



Planting Date: May 15 Hybrid: Varied Population: 36K Row Width: 30" Rotation: CAC Corn Price: \$5.00 Force 6.5G: \$25/A.

Fendt® Momentum® Planter Study

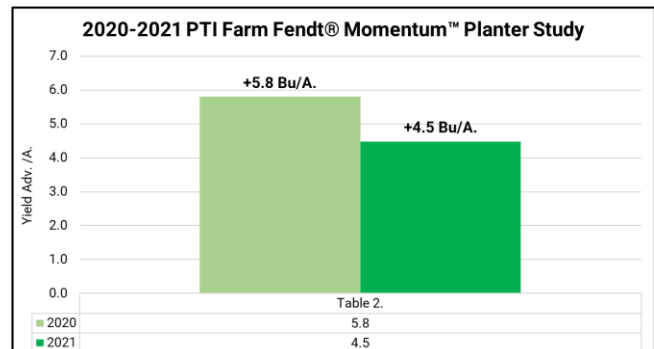
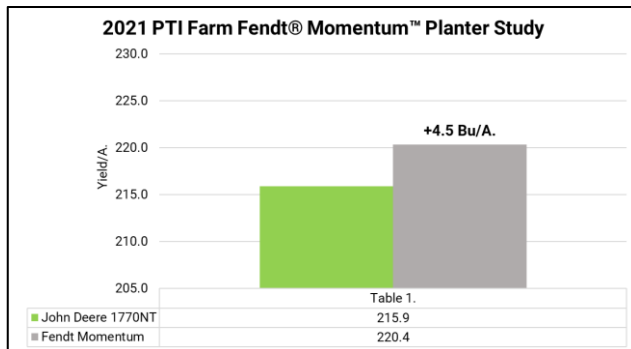
Objective: To evaluate the yield benefit of AGCO’s all new Fendt® Momentum® planter, equipped with a Load Logic System. In 2020, AGCO released the all-new Fendt® Momentum® planter equipped with key agronomic features to help alleviate pinch row compaction. One of those key features is the Load Logic system that includes both a weight transfer and tire inflation system.

In this study, we compare a 16-row John Deere 1770NT planter to that of the new Fendt® Momentum® planter. Each planter was built to exact specifications consisting of Yetter residue managers with CleanSweep®, Dual Band Conceal®, FurrowForce®, vSet®, vDrive®, and DeltaForce® configurations. A Fendt® 1050 row crop tractor pulled the 16-row Momentum® planter, while a Fendt® 942 tractor led the John Deere 1770NT.



Tire inflations for the John Deere planter consisted of 10.2psi in the front and 11.6psi in the rear of the 942 Fendt® tractor and 50psi in all center and wing tires of the planter. The Momentum® planter was set to automatic weight transfer mode, low tire inflation of 10.2psi in the front tires, 11.6psi on the rear tires of the Fendt® 1050 tractor, and 35psi in the planter tires.

Results: Table 1. illustrates the Fendt® Momentum® planter equipped with the Load Logic weight transfer and tire inflation system outperformed the John Deere 1770NT by an average of +4.5 Bu/A. Table 2 summarizes 2020-2021 Momentum® yield gains averaging +5.1 Bu.A.



Broadcast vs Banding Dry Fertilizer Study

Objective: To evaluate yield and economics of traditional broadcast applications of dry fertilizer compared to 8" deep high concentrated strip-till banding.

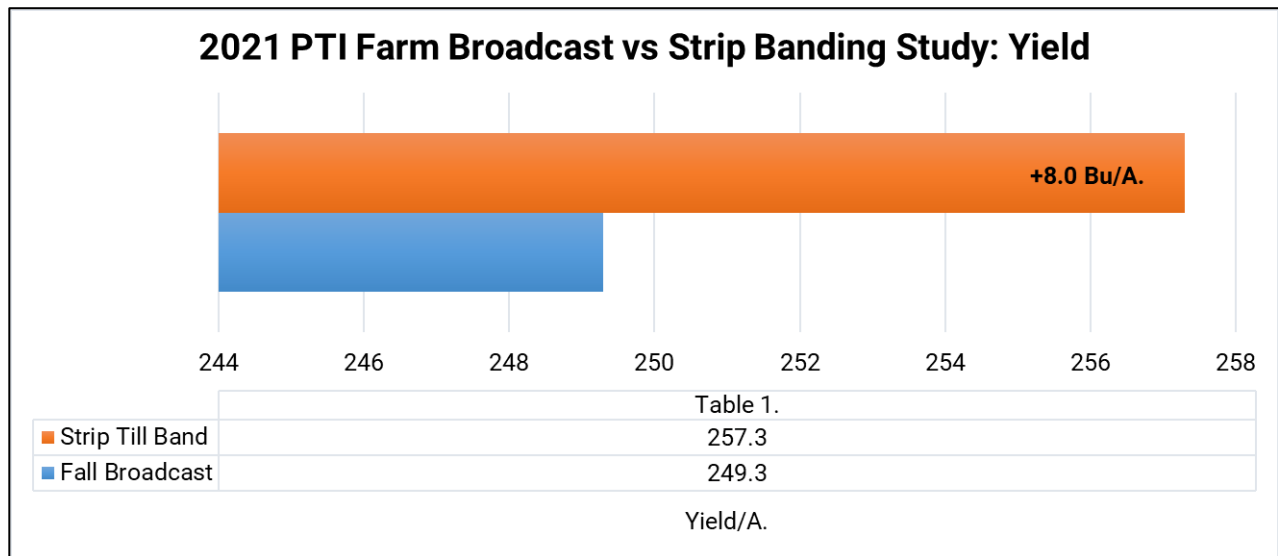
Based upon soil test results and yield goals of 250 Bu/A. corn in a corn/soybean irrigated rotation, 260# 18-46-0 and 140# 0-0-60 was applied in a traditional broadcast surface application made with a traditional spinner truck (Figure 1). Using the same fertilizer rates, a strip-till bar was used to place fertilizer in high concentrated strips 8" deep on 30" corn rows (Figure 2). Corn was then planted directly into the strips above the 8" fertilizer placement. A KUHN Krause Gladiator® pulling a Montag Equipment 2208 Gen 2 fertilizer cart was used to implement this testing program for 2021.

Results Table 1. illustrates strip-till fertilizer resulted in +8.0 Bu/A. yield gains over traditional broadcast applications. Corn yield from broadcast fertilizer averaged 249.3 Bu/A., while strip-till 257.3 Bu/A.

Figure 1. Broadcast Dry Fertilizer



Figure 2. Strip-Till Banded Fertilizer



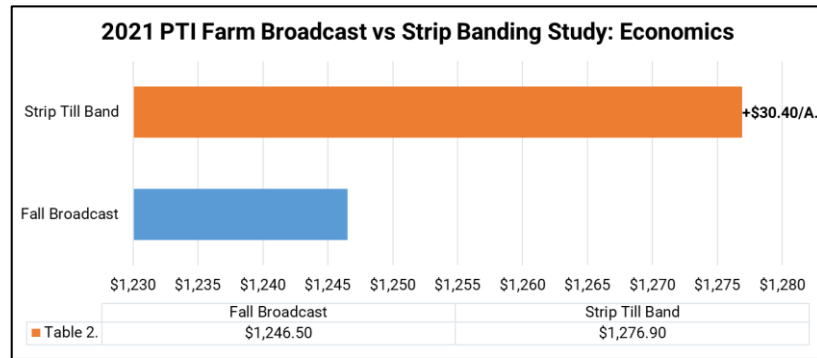
Broadcast vs Banding Dry Fertilizer Study Continued

Using University of Illinois Machinery Cost Estimates in Figure 1., strip-till resulted in additional costs of +\$9.60/A. in comparison to a conventional tillage program. Using this cost scenario, Table 2. illustrates the economic impact from our 2021 study. Strip-till, with its tillage and fertility system, posted positive economic gains of +\$30.40/A. over a conventional tillage system.

Figure 1. University of IL Machinery Cost Estimates

Tillage Practice	Category	Cost
Conventional	Soil Finisher	\$ 11.10
	Plant	\$ 17.20
	Fertilizer Spread	\$ 3.00
	Total:	\$ 31.30
Strip Till	Strip	\$ 17.30
	Plant	\$ 17.20
	Burndown	\$ 6.40
	Total:	\$ 40.90

2020 data revealed banded fertilizer with strip-till resulted in yield gains of 17.6 Bu/A. with net returns of +\$52.30/A. Seeing these optimistic results for a second year in a row, protocols have been implemented to include more strip-till studies with the focus on fertility efficiencies at the PTI Farm in the future.



Broadcast vs Banding Rate Efficiency Study

Objective: To evaluate yield and economics of traditional broadcast applications of dry fertilizer compared to concentrated strip-till bands applied 8" in depth under the corn row.

Based upon soil test results and yield goals of 250 Bu/A. corn in a corn/soybean rotation, 260# 18-46-0 and 140# 0-0-60 was applied as a recommended fertility application from a recent soil test.

To study placement efficiency, dry fertilizer was applied in a traditional broadcast surface application as a spinner truck (Figure 1). Using the same fertilizer rates, a strip-till bar was used to place fertilizer in high concentrated strips 8" deep on 30" corn rows (Figure 2). Corn was then planted directly into the strips above the 8" fertilizer placement. Corn was also planted in a strip-till situation with the broadcast fertilizer, however as surface applied on top of the fall strips. A KUHN Krause Gladiator® pulling a Montag Equipment 2208 Gen 2 fertilizer cart was used to implement this testing program for 2021.

To then study rate efficiency, fertilizer was applied at the following rate structure in both strip-till bands and broadcast applications:

- ✓ 100% Fertilizer Rate
- ✓ 75% Fertilizer Rate
- ✓ 50% Fertilizer Rate
- ✓ 25% Fertilizer Rate
- ✓ 0# Rate

Figure 1. Broadcast Dry Fertilizer



Figure 2. Strip-Till Banded Fertilizer with Montag cart



Figure 3. KUHN Krause strip-till unit



Broadcast vs Banding Rate Efficiency Study Continued

Results: Table 1. illustrates the yield of all rates in band and broadcast applications. Highest yield came from rates at either 100% or 75% in bands at 264.7 to 264.3 Bu/A. Overall, high concentrated bands surpassed broadcast spreading yields at every individual rate percentage.

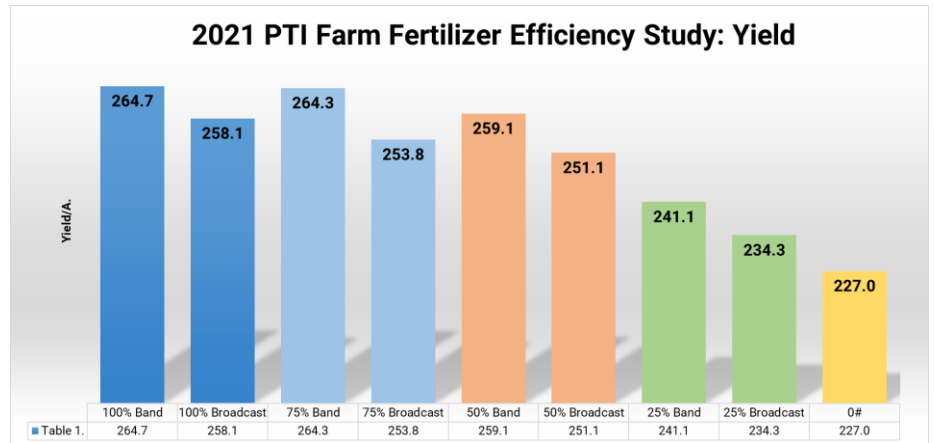
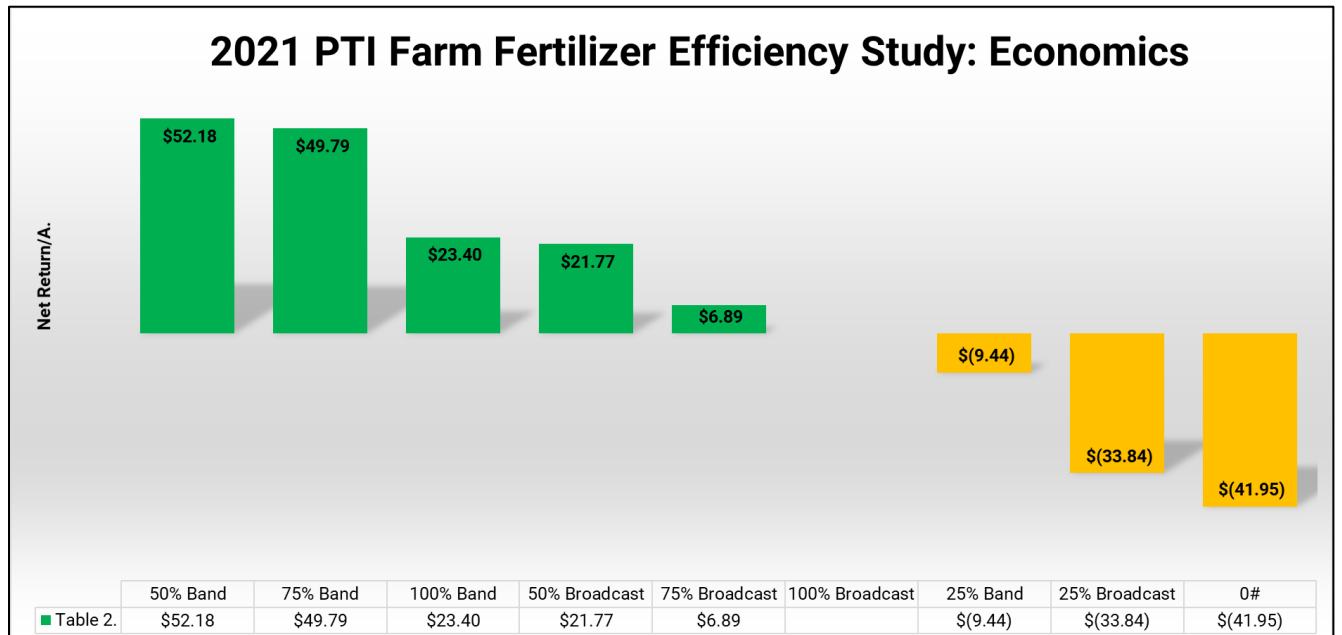


Table 2. tells the story very well as it summarizes economic optimum rate and placement. 50%-75% rate bands achieved highest net returns and resulted in +\$49.79/A. to +\$52.18/A. over 100% broadcast rates respectively. 100% bands proved net returns over 100% broadcast fertilizer by +\$23.40/A.

Where we got in trouble with this study, was reducing fertilizer rate too far. Both 25% band and broadcast rates proved negative losses of **-\$9.44** to **-\$33.84/A.** compared to that of 100% broadcast, indicating too low of fertilizer rate. The same applies with the 0# rate, as it proved economic losses of **-\$41.95/A.**



Marco QuickGrow™ LTE FurrowJet® Study

Objective: To evaluate the yield and net return of Marco Fertilizer’s QuickGrow LTE 6-20-4-.25Zn-2.7S liquid starter fertilizer at rates of 4, 6 and 8 Gal/A. applied in an at-plant 3-way FurrowJet® system. QuickGrow LTE is a 70% polyphosphate and 30% orthophosphate formulation of nitrogen, phosphorus, potassium, sulfur, and EDTA Zn.

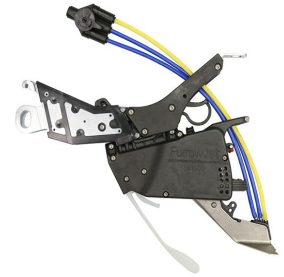
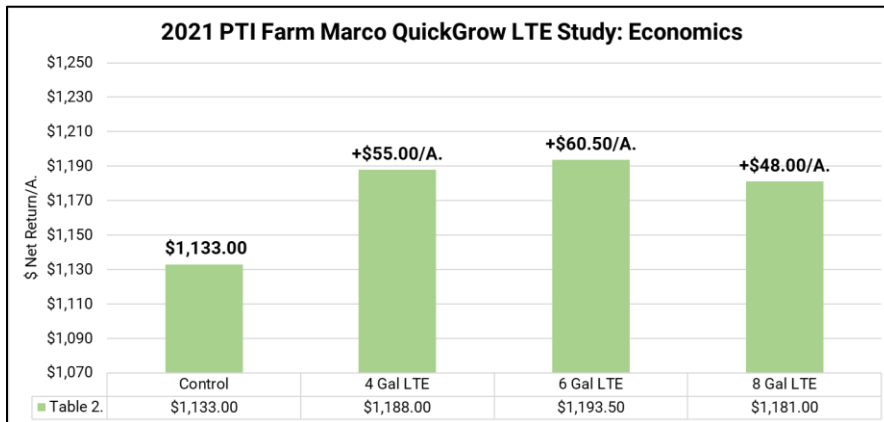
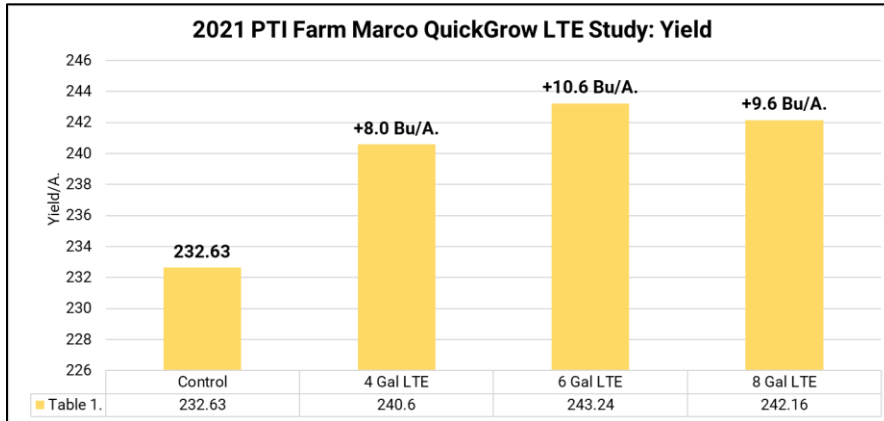


Figure 1. FurrowJet® Placement



Results: All rates of Marco QuickGrow LTE resulted in positive yield gains. 6 Gal/A. rates achieved both agronomic and economic optimum rate, with yield gains of +10.6 Bu/A. and net returns of +\$60.50/A.

The Anderson's® Corn Nutritional Study

Objective: To evaluate the yield and economic impact of a corn liquid starter fertilizer nutritional program from The Andersons. This trial consisted of the following:

Protocol and Placement:

Program 1: 5oz Root Growth Stimulator (RGS) + 3 Gal/A. Ammonium Thiosulfate (ATS)
Conceal®

Program 2: 5 Gal/A. Season Pass Plus 6-18-6 with MicroCarb FurrowJet® Wings+ 1pt BioPass
FurrowJet® Center

Program 3: Combination Treatment (Program 1+2)



<u>Product</u>	<u>Fertilizer Analysis</u>	<u>Placement of Fertilizer</u>
5oz/A. Root Growth Stimulator	14-0-0 + 17.0Zn	Conceal® Single Band
3 Gal/A. (ATS)	12-0-0-26S	Conceal® Single Band
5 Gal/A. SeasonPass Plus w/MicroCarb	6-18-6-1S-.46Zn-.4 Carbon + .1B-.5Mn-.75Zn	FurrowJet® Wings
1pt BioPass	-----	FurrowJet® Center



Figure 1. Conceal® Single or Dual Placement 3" from Seed Trench, 1.5" in Depth



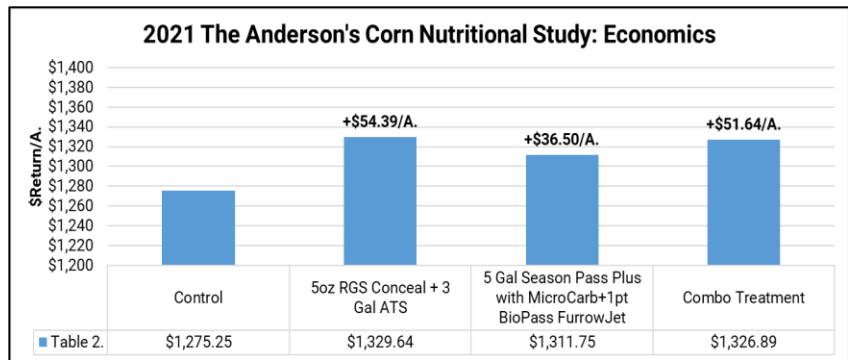
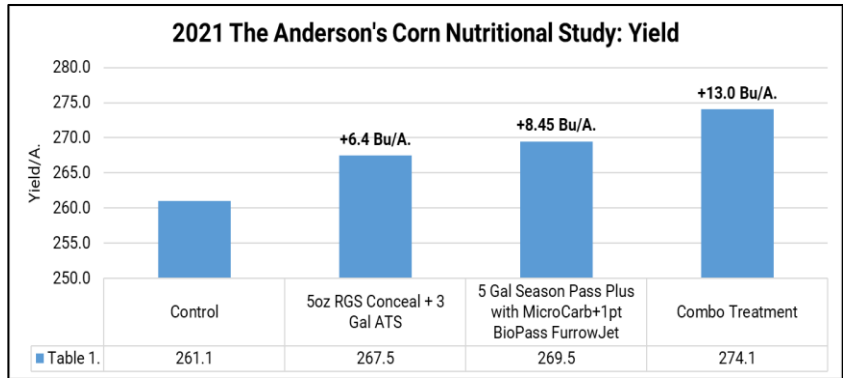
Figure 2. FurrowJet® Placement

The Anderson's® Corn Nutritional Study Continued

Results: Conceal® treatments offered +6.4 Bu/A. yield gains with positive net returns of +\$54.39/A.

FurrowJet® treatments of Season Plus with MicroCarb + 1pt BioPass resulted in yield gains of +8.45 Bu/A. with positive net returns of \$36.50/A.

The combination of Conceal® and FurrowJet® treatments offered the highest yields in the study at +13.0 Bu/A., along with positive net returns of +\$51.64/A.



Planting Date: 5/20 Hybrid: DKC 65-95 Population: 36K Row Width: 30" Rotation: CAB Corn Price: \$5.00 RGS: \$2.27/A.
 Season Pass: \$22.50/A BioPass: \$13.25/A ATS: \$5.34/A Fert Reallocation: \$30/A.

AgroLiquid® Starter Fertilizer Study

Objective: To evaluate the yield and economic impact of a corn liquid starter fertilizer nutritional program from AgroLiquid using FurrowJet® and Conceal® (Figure 1.) The protocol consists of the following:

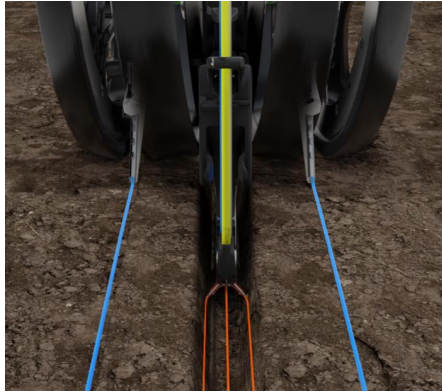


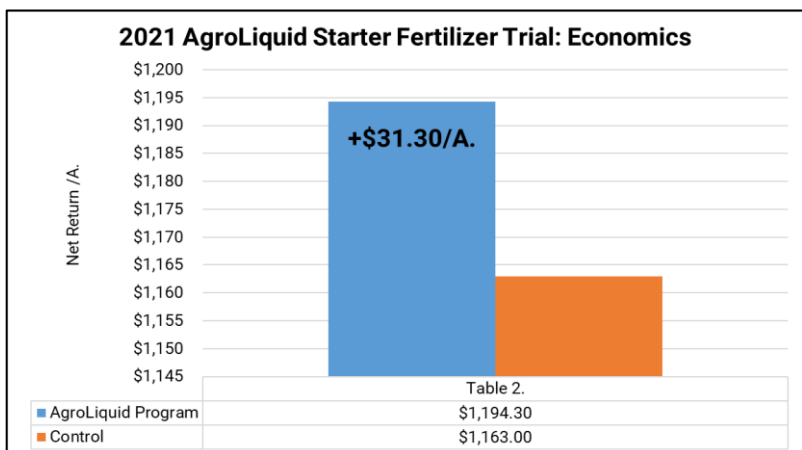
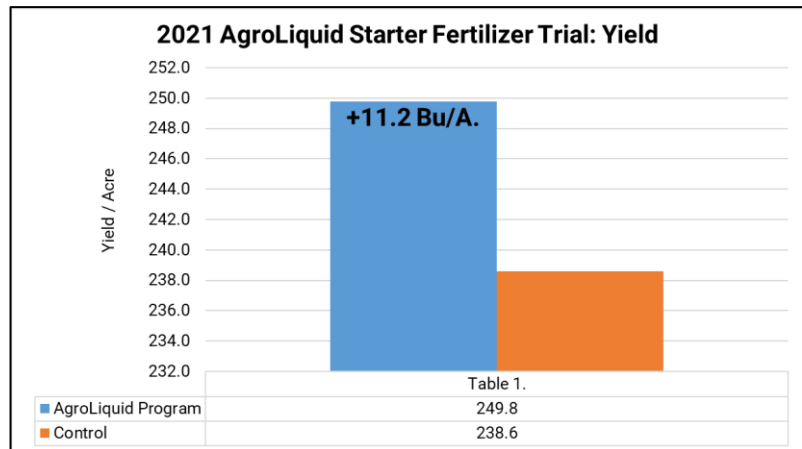
Figure 1. Conceal® and FurrowJet® Placement

Results: Table 1. illustrates the AgroLiquid fertility program achieved average yield gains of +11.2 Bu/A. Table 2. depicts net returns tallied a positive return on investment of +\$31.30/A.



Figure 2.

Product/A.		Application
3-Gal Spring-uP®	4-15-3	FurrowJet®
1 Gal/A. SureK®	2-1-6	FurrowJet®
0.25 Gal/A. Micro 500™	.02B-.25Cu-.37Fe-1.2Mn-1.8Z	FurrowJet®
0.25 Gal/A. Manganese	4% Manganese Sulfate	FurrowJet®
.125 Gal/A. eNhance™	7-0-0-8.7S-.07MN-.07Zn	Conceal®
2 Gal AccessS®	7-0-0-17S-.25Fe-.05Mn-.05Zn	Conceal®
2 Gal/A. SureK	2-1-6	Conceal®



Planting Date: 4/27 Hybrid: DKC 64-64 Population: 36K Row Width: 30" Rotation: CAB Corn Price: \$5.00 \$30/A Fert. Reallocation

SpringuP: \$5.17/Gal SureK: \$6.08/Gal Micro500: \$17.18/Gal Manganese: \$19.66/Gal eNhance: \$17/Gal AccessS: \$4.81/Gal

NACHURS® imPulse® FurrowJet® Center Placement Trial



Objective: To evaluate the effect on yield and economics when NACHURS imPulse 10-18-4 starter fertilizer (Figure 2.) is placed at 4 to 7 Gal/A. in FurrowJet® **center** only configurations (Figure 1). NACHURS imPulse is a premium 100% orthophosphate in-furrow liquid fertilizer that contains NACHURS Bio-K technology.

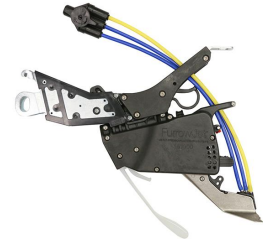


Figure 1. FurrowJet® Placement

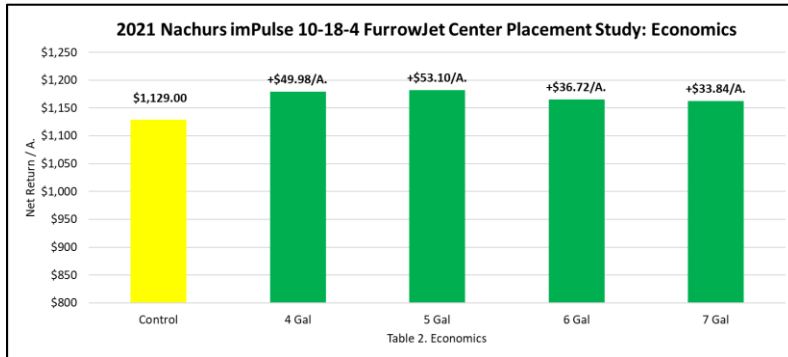
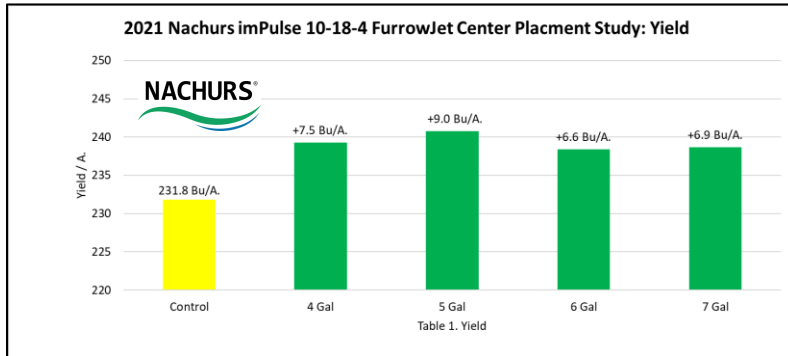


Figure 2. Nachurs imPulse® Starter

10-18-4 Liquid Fertilizer

Nutrients Supplied (pounds per gallon)

Total Nitrogen (N)	1.06
Available Phosphate (P ₂ O ₅)	1.91
Soluble Potash (K ₂ O)	0.42

Results: Tables 1-2, illustrate that all rates of imPulse 10-18-4 resulted in yield gains from +6.6 to +9.0 Bu/A., with positive return on investment from +\$33.84/A. to +\$53.10/A. Both agronomic and economic optimum rate occurred at 5 Gal/A.

Planting Date: 5/17 Hybrid: Integra 6342 Population: 36K Rotation/Row

\$30/A Fert. Reallocation imPulse: \$4.38/Gal

Derived from: ammonium hydroxide, urea, phosphoric acid, potassium acetate, and potassium hydroxide.

at +9.0 Bu/A. yield gains and positive return on investment of +\$53.10/A. As rates increased above 5 Gal/A., no additional yield gain was observed.

NACHURS® imPulse® FurrowJet® Wing Placement Trial

Objective: To evaluate the effect on yield and economics when NACHURS imPulse 10-18-4 starter fertilizer (Figure 2.) is placed at 4 to 7 Gal/A. in FurrowJet® **wing** only configurations (Figure 1). NACHURS imPulse is a premium 100% orthophosphate in-furrow liquid fertilizer that contains NACHURS Bio-K technology.

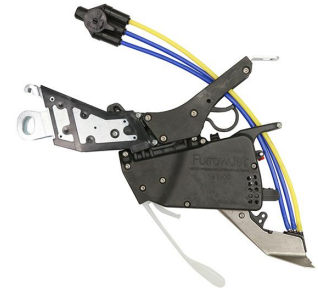


Figure 1. FurrowJet® Placement

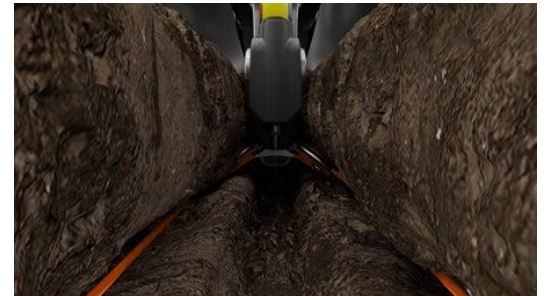
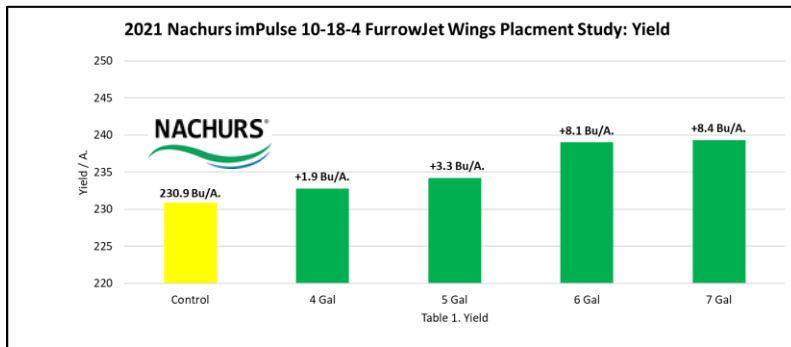


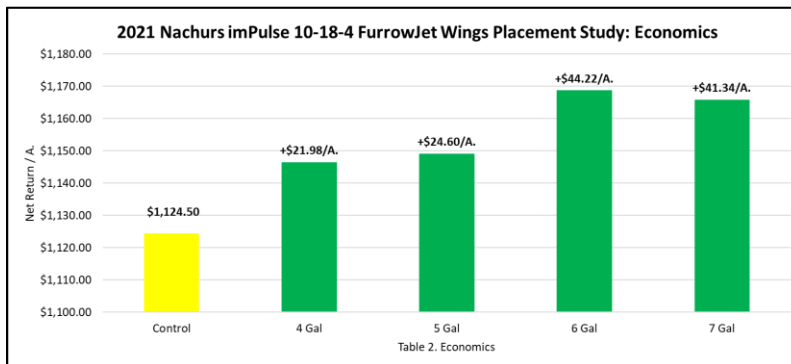
Figure 2. Nachurs imPulse® Starter

10-18-4 Liquid Fertilizer

Nutrients Supplied (pounds per gallon)

Total Nitrogen (N)	1.06
Available Phosphate (P ₂ O ₅)	1.91
Soluble Potash (K ₂ O)	0.42

Derived from: ammonium hydroxide, urea, phosphoric acid, potassium acetate, and potassium hydroxide.



Results: Tables 1-2, illustrate rates of imPulse 10-18-4 at 7 Gal/A. achieved agronomic optimum yield at +8.4 Bu/A. However, 6 Gal/A. proved economic optimum rate of gains of +\$44.22/A.

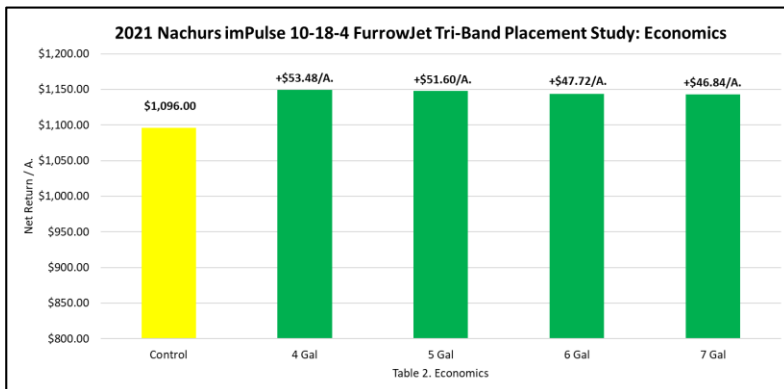
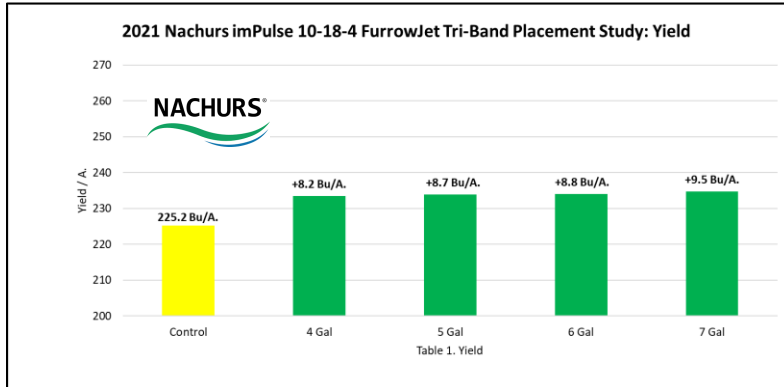
Lower rates of 4 to 5 Gal/A. of imPulse incurred lower overall yield responses, which may be a result of wing only placement. FurrowJet® center applications may be more ideal at these lower rates.

Planting Date: 5/17 Hybrid: Integra 6342 Population: 36K Rotation/Row Width: CAB,30" Corn Price: \$5.00

\$30/A Fert. Reallocation imPulse: \$4.38/Gal

NACHURS® imPulse® FurrowJet® Tri-Band Placement Trial

Objective: To evaluate the effect on yield and economics when Nachurs imPulse 10-18-4 starter fertilizer (Figure 2.) is placed at 4 to 7 Gal/A. in FurrowJet® **tri-band** configurations (Figure 1). NACHURS imPulse is a premium 100% orthophosphate in-furrow liquid fertilizer that contains NACHURS Bio-K technology.



Results: Tables 1-2, illustrate all rates of imPulse 10-18-4 resulted in yield gains and positive return on investment. The highest rate evaluated in this study of 7 Gal/A. achieved agronomic optimum yield at +9.5 Bu/A. However, after cost of product, economic optimum economic rate occurred at the 4 Gal/A. rate with a positive return on investment of +\$53.48/A.

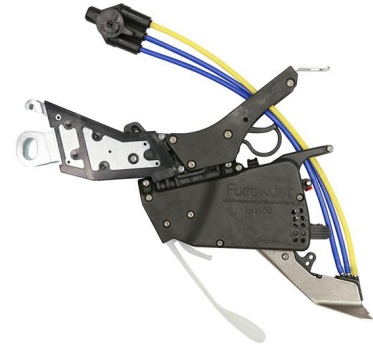


Figure 1. FurrowJet® Placement

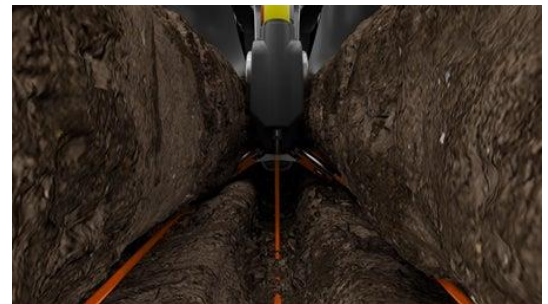


Figure 2. NACHURS imPulse® Starter

10-18-4 Liquid Fertilizer

Nutrients Supplied (pounds per gallon)

Total Nitrogen (N)	1.06
Available Phosphate (P ₂ O ₅)	1.91
Soluble Potash (K ₂ O)	0.42

Derived from: ammonium hydroxide, urea, phosphoric acid, potassium acetate, and potassium hydroxide.

Planting Date: 5/17 Hybrid: Integra 6342 Population: 36K Rotation/Row Width: CAB,30" Com Price: \$5.00

\$30/A Fert. Reallocation imPulse: \$4.38/Gal

NACHURS® Start2Finish™ Corn Fertility Trial



Objective: To evaluate the effect on yield and economics of NACHURS Start2Finish corn fertility program. This 3-way program consists of the following treatments:

At-Plant: 5 Gal/A. imPulse® applied via FurrowJet® 3-way

At-Plant: 2 Gal/A. K-Fuse® applied via Conceal® dual band

Foliar: 1 Qt/A. FinishLine® + 1Gal TripleOption®

NACHURS imPulse

NACHURS imPulse is a premium 100% orthophosphate in-furrow liquid fertilizer that contains NACHURS Bio-K technology, the most plant available source of potassium. Highly available phosphate and potassium promotes improved early season plant health and increased stress tolerance. Specially formulated for corn and wheat crops, NACHURS imPulse offers quick and uniform plant emergence which aids in achieving maximum yield potential.

NACHURS imPulse is seed safe when used at recommended rates, is non-corrosive to equipment, and has excellent cold-weather stability when stored properly (i.e. in flat bottom tanks).

(8-4-6-0.18-0.20Cu-1Mn-1Zn)

NACHURS Finish Line is a uniquely balanced foliar product with low use rates that have a proven record of increasing ROI on many crops. This foliar product is manufactured with the highest quality raw materials containing plant available orthophosphate, fully chelated micronutrients, surfactants, compatibility agents and organic acids as well as the latest potassium technology: NACHURS Bio-K. This ensures compatibility with most crop protection products and provides the best available nutrients essential for maximizing yield potential.*

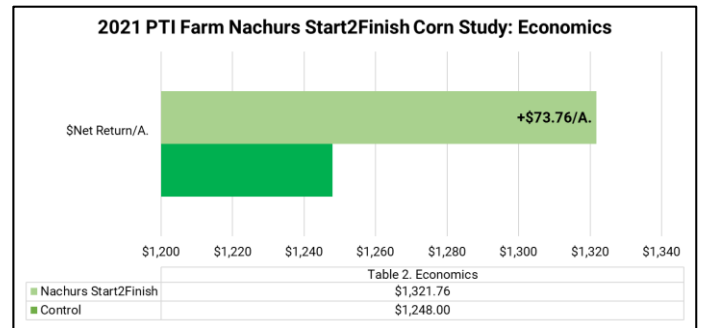
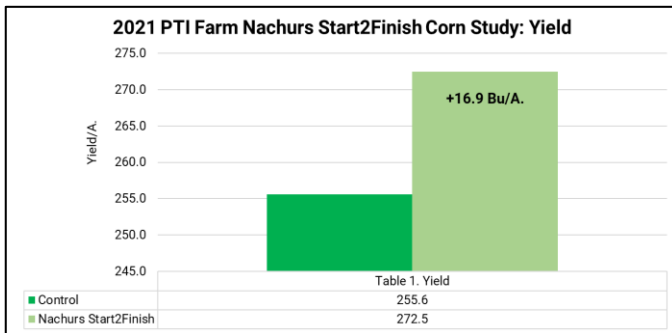
NACHURS Triple Option

NACHURS Triple Option is a versatile NPKS liquid fertilizer that contains 100% orthophosphate, sulfur, and NACHURS Bio-K technology, the most plant available source of potassium. NACHURS Triple Option is a high orthophosphate fertilizer offering immediate nutrient availability. Adapted for use on all crops, NACHURS Triple Option offers the flexibility for in-furrow, foliar, fertigation, and transplant applications. It is also compatible with many crop protection products and other crop technologies, aligning to promote crop yield and quality.

Generations of America's Farmers have used NACHURS® liquid fertilizers because it is a quality brand they can trust. NACHURS® Bio-K® products offer the latest technology advancements farmers need to take their crops to the next level.

Simple yet effective, profitable yet sustainable, Start2Finish™ is a comprehensive liquid fertilizer program to maximize your crop's potential

Results: Tables 1-2 illustrate that Nachurs Start2Finish proved agronomic gains of +16.9 Bu/A., along with positive economic gains of +\$73.76/A.



Planting Date: 5/27 Hybrid: DKC 59-82 Population: 36K Row Width: 30" Rotation: CAB Corn Price: \$ 5.00

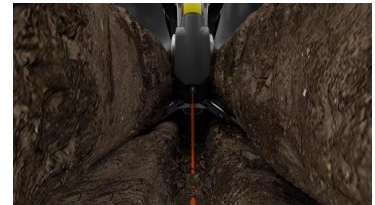
\$30/A Fert. Re-Allocation imPulse: \$4.38/Gal. K-Fuse: \$4.80/Gal. Finish Line: \$14.40/Gal TripleOption: \$5.64/Gal

Pivot Bio PROVEN40® Nitrogen Mgt. Study

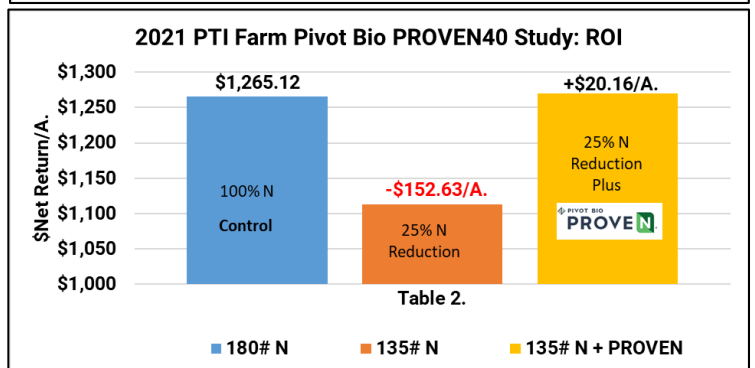
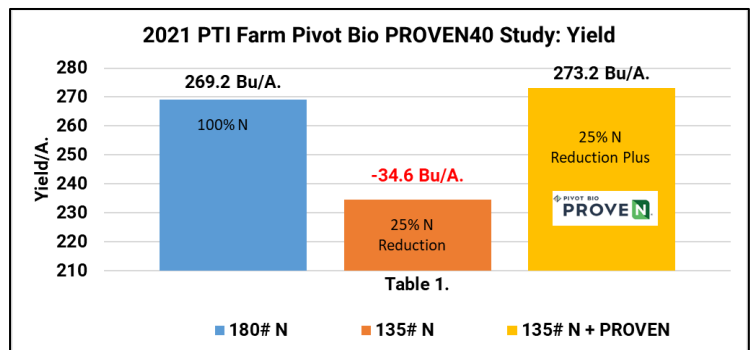
Objective: To evaluate the effect on yield and economics using Pivot Bio’s PROVEN40, the first nitrogen-producing microbe for corn. Pivot Bio PROVEN microbes are applied in-furrow during planting. These microbes create a symbiotic relationship with the corn plant, producing nitrogen and delivering it directly to the roots of the corn plant. Microbes then continually feed nitrogen to the corn plant throughout the growing season. Pivot Bio PROVEN40 microbes adhere to the roots of the corn plant and support a reliable and consistent method for delivering plant nutrition. For this agronomic study, nitrogen rate is evaluated at 100% full rates (180#N) as well as -25% N reductions (135# total N or 40# N reduction). Pivot Bio PROVEN40 was applied in-furrow at planting via FurrowJet® treatments (Figure 1).



Figure 1. FurrowJet® At-Plant



Results: Table 1. illustrates the control in the study being 100% nitrogen rates (180#N), offering base yields of 269.2 Bu/A. Reducing nitrogen by 40# (or 25%) resulted in losses of **-34.6 Bu/A.** However, when PROVEN40 was added to that same nitrogen reduction rate of 135#N, yields were +4.0 Bu/A. better than the control rate of 180# N/A. Table 2. reveals the economics of the PROVEN40 system. Stand-alone 25% nitrogen reductions resulted in economic losses of **-\$152.63/A.** PROVEN40 applied via FurrowJet®, even with -25% N reductions, resulted in an economic profit of **+\$20.16/A.** over the standard 180# N control rate.



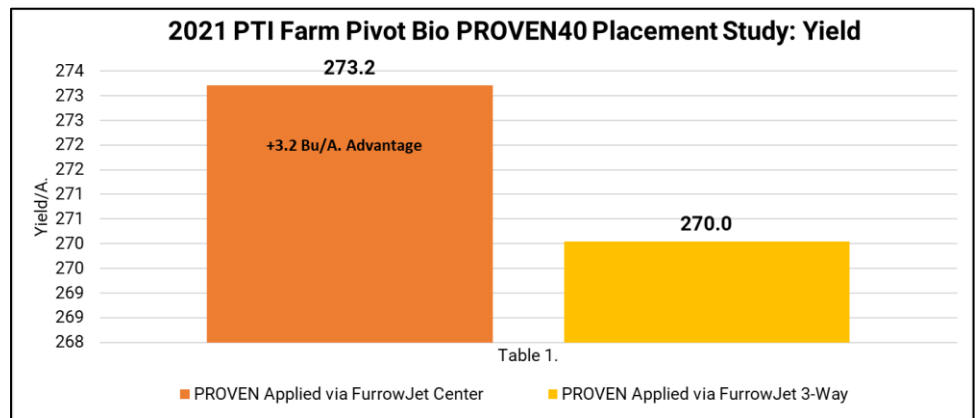
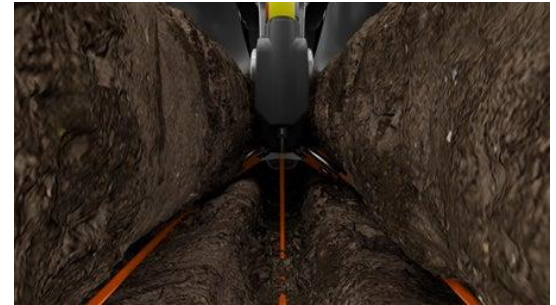
In summary, PROVEN40 treatments offered the ability to reduce nitrogen rates without sacrificing yield or economic losses. In 2020, the first year of testing with this product, yield was improved by +1.7 Bu/A., but only economic gains of +\$1.02/A. We look forward to a third year of testing in 2022, but for now we realized a win-win situation; a win for the environment with lower applied agronomic nitrogen rates, as well as a win with economics.

Pivot Bio PROVEN40® FurrowJet® Placement Study

Objective: To evaluate the yield and economics of in-furrow placement of Pivot Bio’s PROVEN40, the first nitrogen-producing microbe for corn applied via FurrowJet® wing or center application. Pivot Bio PROVEN40 microbes are applied in-furrow during planting. Microbes in PROVEN40 create a symbiotic relationship with the corn plant, produce nitrogen and deliver it directly to the roots of the corn plant. Microbes then continually feed nitrogen to the corn plant throughout the growing season. Pivot Bio PROVEN40 microbes adhere to the roots of the corn plant and supports a reliable and consistent method for delivering plant nutrition. This agronomic study focuses on best at-plant in-furrow application methods including FurrowJet® center versus wing applications (Figure 1).



Figure 1. FurrowJet® Center vs Wing Placement



Results: Table 1. illustrates Pivot Bio PROVEN40

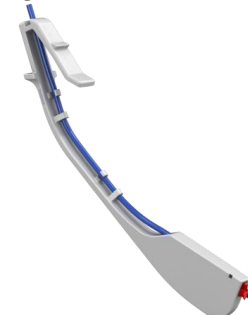
resulted in advantages for FurrowJet® center treatments by +3.2 Bu/A. In our first year of testing in 2020, FurrowJet® center application also resulted in yield gains of +3.8 Bu/A.

For growers wanting to apply this type of at-plant in-furrow application, FurrowJet® as well as a SmartFirmer® (Figure 2.) or Keeton® Seed Firmer (Figure 3.) could also be utilized on the planter to achieve that near seed placement and concentration.

Figure 2. SmartFirmer®



Figure 3. Keeton® Seed Firmer



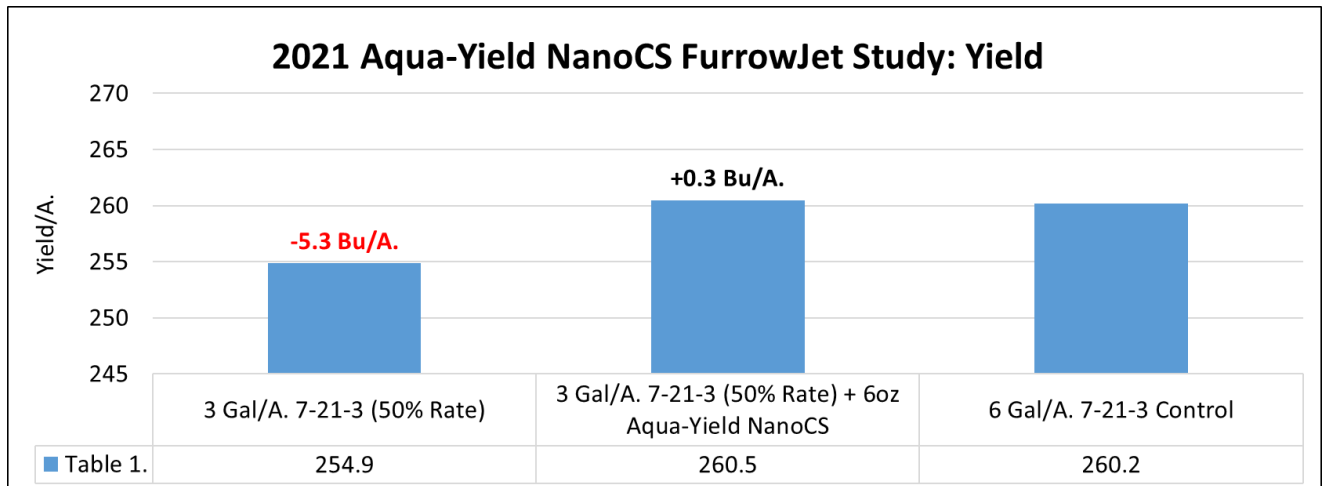
Aqua-Yield® NanoCS™ FurrowJet® Study

Objective: To evaluate yield and economics of NanoCS by AQUA-YIELD. NanoCS is a starter fertilizer enhancer with a robust combination of NanoShield Technology®, balanced NPK, Zinc, and Bio Stimulant. Aqua-Yield products contain nanoparticles that penetrate cell walls and creates a nano-sized shield around nutrient molecules/ions. This technology delivers essential nutrients into the seed for rapid germination and growth.

Figure 1: FurrowJet® In-Furrow Application



This trial aims to establish the efficiency of Aqua-Yield's NanoCS nano-liquid based fertility product in tandem with a 7-21-3 traditional starter fertilizer. Performance of a 50% rate reduction (3Gal/A.) of 7-21-3 is then compared to the 100% rate (6 Gal/A). NanoCS was applied in-furrow at planting in a FurrowJet® center only application (Figure 1.)



AQUA-YIELD®

NanoCS™

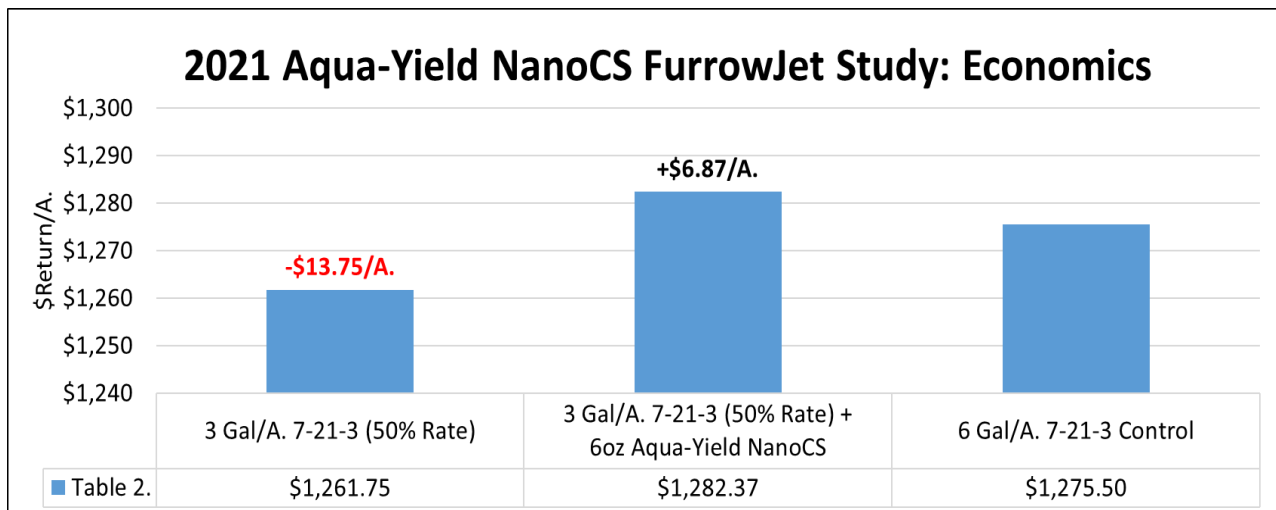
Aqua-Yield® NanoCS™ FurrowJet® Study Continued

Results: Table 1. illustrates yield results of all treatments. The 100% rate control treatment at 6 Gal/A. of 7-21-3 resulted in yields of 260.2 Bu/A., while 50% reductions reduced corn yield by **-5.3 Bu/A.** of the control. Aqua-Yield's NanoCS tank-mixed with 50% 7-21-3 rates resulted in +0.3 Bu/A. yield improvement over and above the 100% rate control treatment.



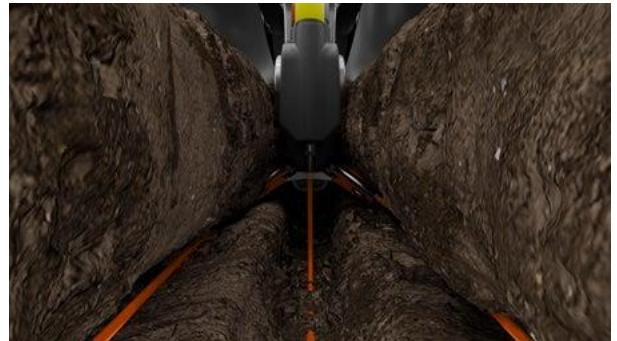
Table 2. illustrates the overall economics of the fertility study. Reducing 7-21-3 starter rates 50% resulted in economic losses of **-\$13.75/A.**, while the NanoCS tank-mix eliminated these losses and incurred a positive return on investment of +\$6.87/A.

As a first-year product study at the PTI Farm in 2021, we are interested in future results of this technology allowing the ability to reduce fertilizer rates without sacrificing yield or profitability.



AGROTECH NutriCharge® Phosphorus Efficiency Study

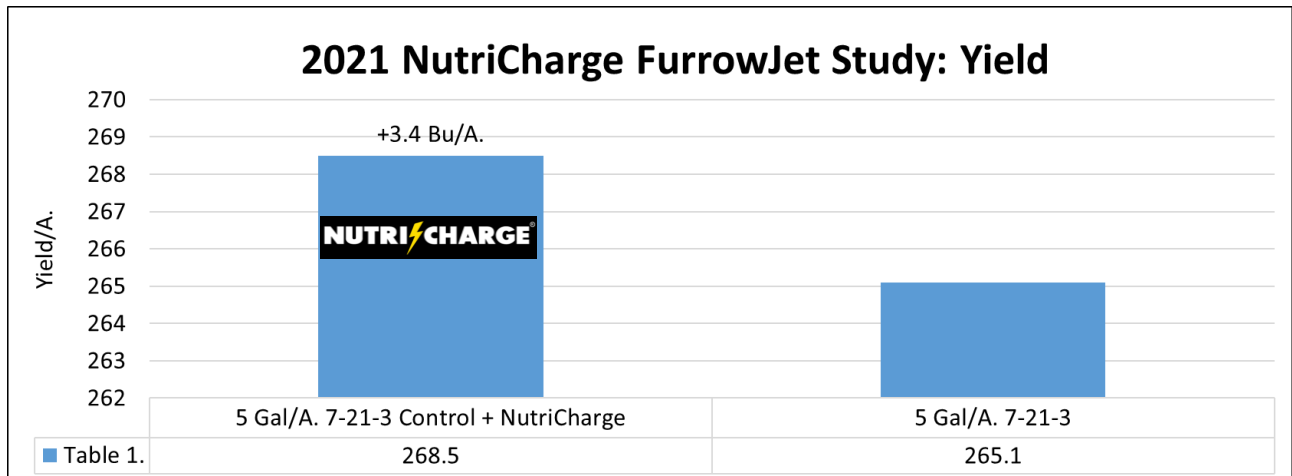
Objective: To evaluate the yield and economics of AgroTech’s NutriCharge, a phosphorus efficiency product that when applied to phosphate (P) fertilizer, significantly increases single season P availability and plant uptake.



It has been theorized that 80% of P fertilizer applied to the soil is unavailable in a growing season. P fertilizer is mined from a mineral called apatite found in rock form within the soil, mostly calcium phosphate. Once mined, it’s processed into fertilizer and upon application to the soil, the P fertilizer reacts quickly with cations in the soil (calcium, aluminum, and iron) going back into an unavailable form. NutriCharge keeps your P available by preventing it from locking up in soil allowing the ability to double single season P availability.

This agronomic study focuses on NutriCharge applied with and without a 5 Gal/A. rate of a Figure 1. FurrowJet® 3-Way In-Furrow Tri-Band liquid 7-21-3 at-plant starter fertilizer applied in a FurrowJet® 3-way in-furrow tri-band.

Results: In this first year PTI agronomic study, FurrowJet® applications of NutriCharge resulted in yield gains of +3.4 Bu/A., as well as a positive return on investment of +\$12.62/A.

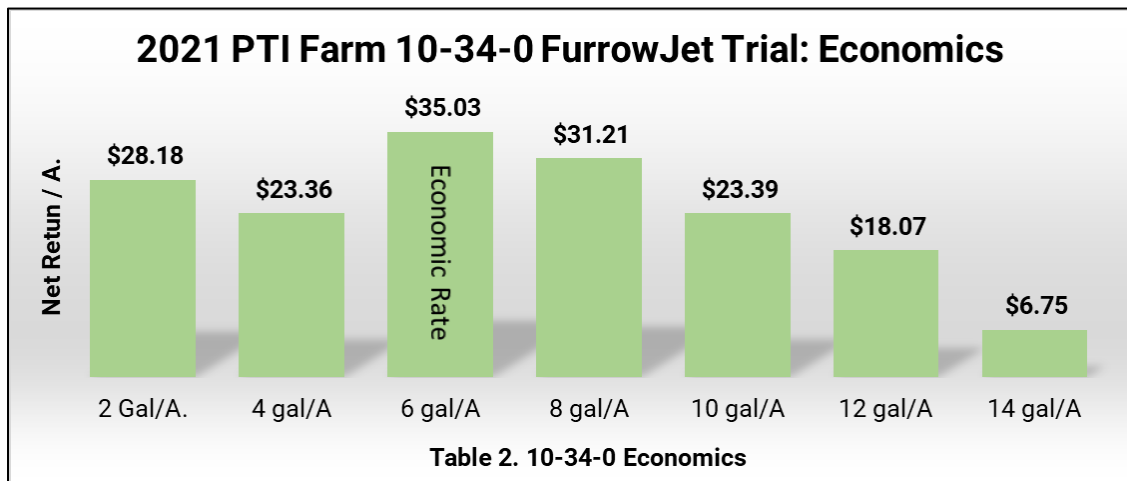
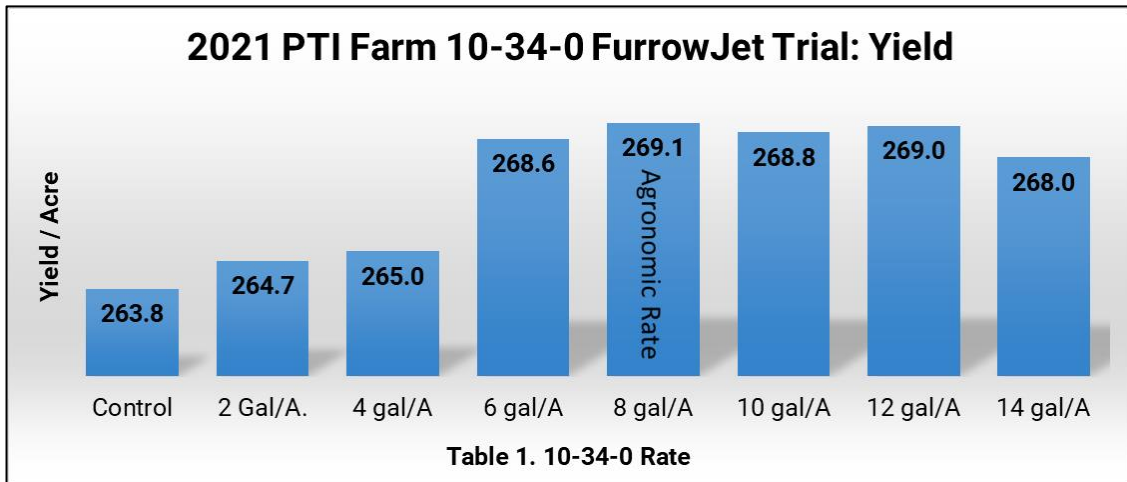


10-34-0 FurrowJet® Study

Objective: To evaluate the yield and net return of 10-34-0 liquid starter fertilizer. Seven different rates were used in a tri-band FurrowJet® system application at planting. 10-34-0 is a 70% polyphosphate formulation of nitrogen and phosphorus.

Results: 8 Gal. rates of 10-34-0 resulted in agronomic optimum rate, however economic optimum rate occurred at 6 Gal/A. with yield gains of +4.8 Bu/A. resulting in positive net returns of +\$35.03/A. As rates of 10-34-0 exceeded 8 Gal/A., yields were stagnant.

Figure 1: FurrowJet® 3-Way In-Furrow Band



Phosphorus Placement Study

Objective: This study evaluates phosphorus placement efficiency when applied in and out of the furrow at planting. Phosphorus is immobile in the soil, meaning it does not move. Diffusion to the root has been studied to move only about 1/8 of an inch per year, which could lead to relatively small amounts of phosphorus in soil within that distance of a root. Thus, roots must grow through the soil to get the phosphorus the plant needs.

This study evaluates yield and economics of phosphorus placement efficiency when 10-34-0 is applied in both FurrowJet® system in-furrow as well as dual band Conceal® system out of furrow applications.

FurrowJet® system is a planter fertilizer attachment (Figure 1.) that enables placement of not only an in-furrow starter fertilizer, but also a dual-band of fertilizer 3/4" on each side of the seed.

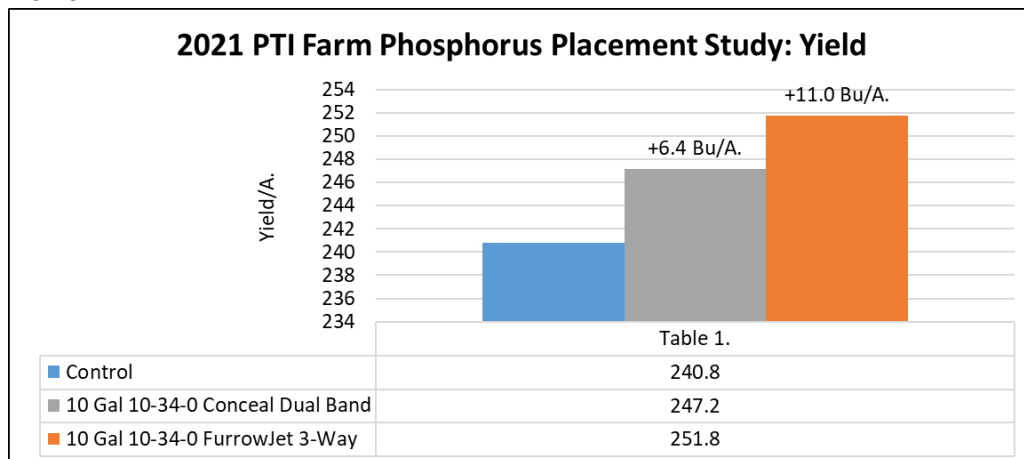
Conceal® system is a unique planter attachment that allows growers to place nutrients in a high concentration dual or single band positioned 3" away from the seed trench in depths near 1.5" (Figure 2).

Results: Table 1. illustrates 2021 yield data where 10-34-0 applications provided overall yield gains of +6.4 to +11.0 Bu/A. However, in-furrow applications provided additional gains +4.6 Bu/A. over Conceal® system applications, which represents a +72% increase in efficiency. Using \$5.00/Bu. corn, this equates to a +\$23.00/A. advantage for phosphorus applied closer to the seed in-furrow.

Figure 1: FurrowJet® 3-Way In-Furrow



Figure 2: Dual Band Conceal® Out of Furrow



Planting Date: 5/5 Hybrid: AgriGold 645-16 Population: 36K Row Width: 30" Rotation: CAB Corn Price: \$5.00 10-34-0: \$545/T

L-CBF 7-21-3 MKP FurrowJet® Study

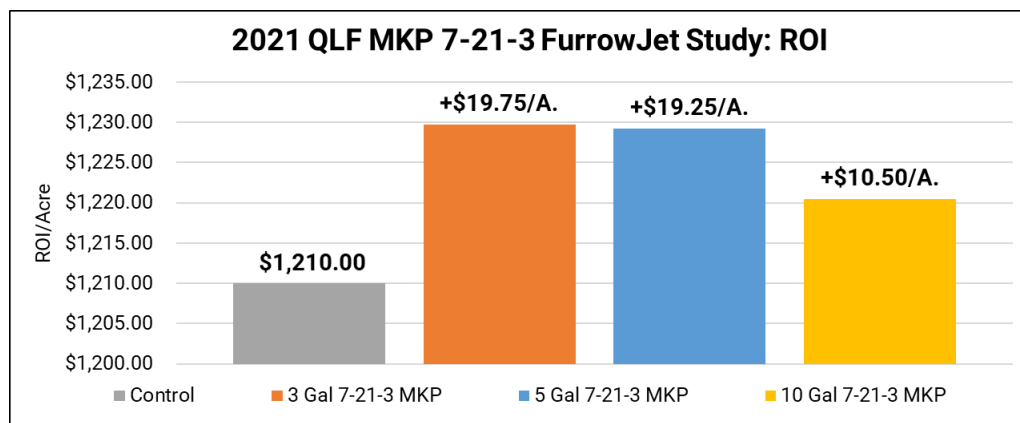
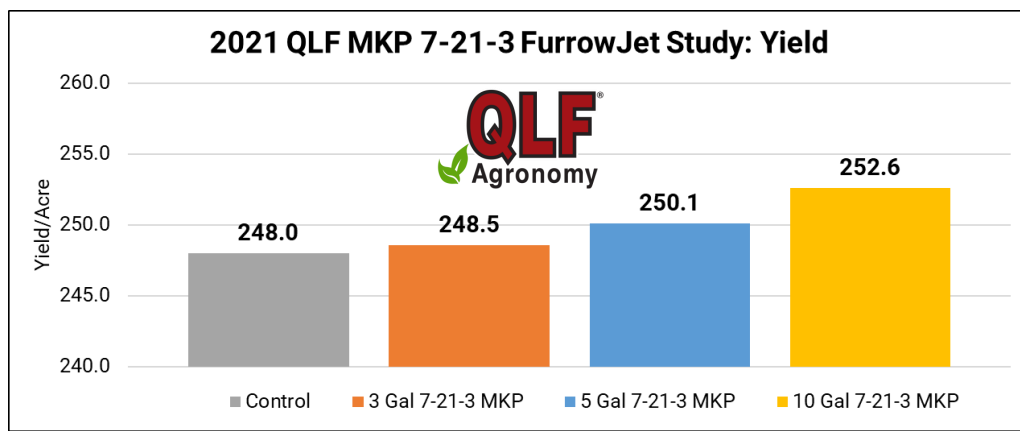
Objective: To evaluate yield and net return of QLF® Agronomy’s Liquid Carbon-Based Fertilizer (L-CBF) starter 7-21-3 MKP applied through a FurrowJet® in-furrow tri-band system (Figure 1.) at 3, 5 and 10 Gal/A. rates.

L-CBF 7-21-3 MKP is liquid starter blend derived from premium orthophosphate MKP (monopotassium phosphate) for plant available phosphorus, available carbon from sugar cane molasses as an energy source for soil microbes and enhanced biological function with an added fermentation yeast extract.

Figure 1. FurrowJet® Tri-band Application



Results: The tables below illustrate that the 10 Gal/A. rate provided agronomic optimum yield, while the 3 Gal/A. provided economic optimum return.



Stoller®USA FurrowJet® Study

Objective: This FurrowJet® system application trial evaluates the yield and net return of StollerUSA's Fortified Stimulate® Yield Enhancer Plus, Charge 12%™ and Harvest Plus™ applied in FurrowJet® tri-bands. (Figures 1-2.)

Fortified Stimulate® Yield Enhancer Plus is a plant growth regulator and EPA registered plant bio-stimulant that has four growth hormone ingredients that promotes plant growth. This product contains four key plant hormones including Cytokinin, Gibberellic acid, Indole-3-butyric acid, and Indole-3-acetic acid.

Charge 12% is an organic humic acid that improves nutrient utilization, root development, and soil aggregation. It is OMRI Listed for use in organic production.

Stoller's Harvest Plus is 8-0-0 premium liquid fertilizer that also contains 3% Sulfur, .25% Boron, 3% Manganese, and 3% Zinc.

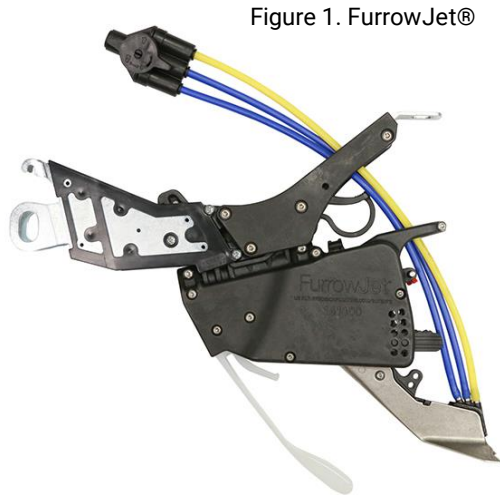


Figure 1. FurrowJet®



ACTIVE INGREDIENTS:	
Cytokinin (as kinetin)	0.009%
Gibberellic acid	0.005%
Indole-3-butyric acid	0.005%
Indole-3-acetic acid	0.005%
OTHER INGREDIENTS:	99.976%
Total	100.000%

CONTAINS NON-PLANT FOOD INGREDIENTS:	
0.009% Cytokinin	
0.005% Gibberellic Acid	
0.005% Indole-3-butyric Acid	
0.005% Indole-3-acetic Acid	

Information regarding the contents and levels of metals in this product is available on the internet at <http://www.aapfco.org/metals.html>

Charge 12%

CONTAINS NON-PLANT FOOD INGREDIENT(S):

GUARANTEED ANALYSIS:

Soil Amending/Active Ingredient(s):

Humic Acids (from Leonardite)12%

Total Other/Inert Ingredient(s): (aqueous solution).....88%

Harvest Plus

8-0-0

Enhanced Micro Blend

GUARANTEED ANALYSIS

Total Nitrogen (N).....8%

8% Ammoniacal Nitrogen (N)

Sulfur (S).....3%

3% Combined Sulfur (S)

Boron (B).....0.25%

Manganese (Mn).....3%

3% Chelated Manganese (Mn)

Zinc (Zn).....3%

3% Chelated Zinc (Zn)

Derived from aqueous ammonia, boric acid, manganese sulfate and zinc sulfate chelated with citric acid

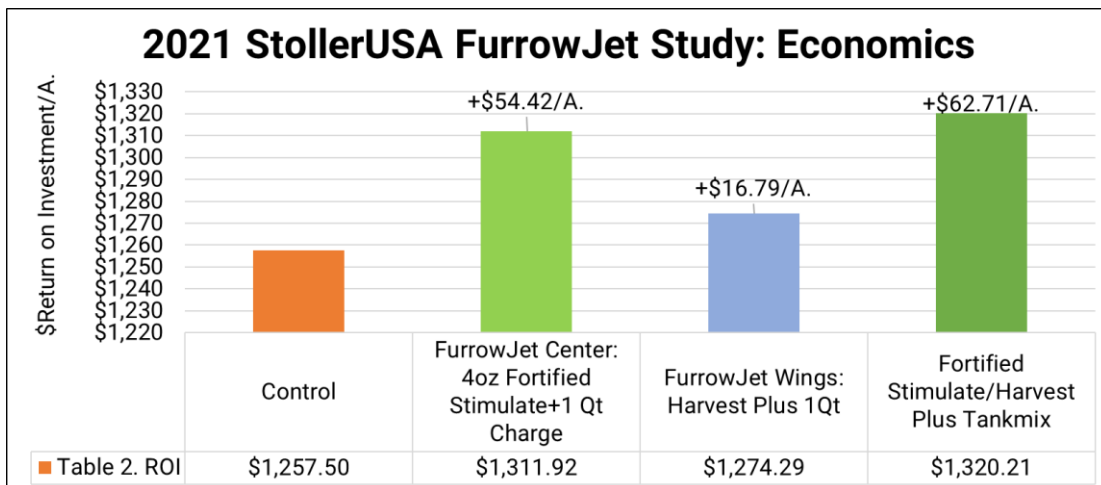
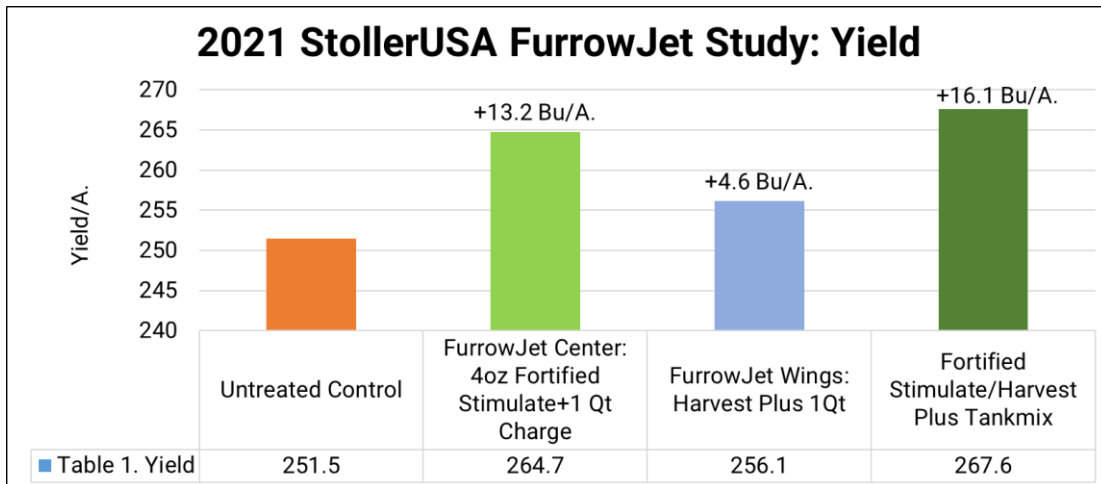


Figure 2. FurrowJet® Tri-Band: Center and Wings

Stoller®USA FurrowJet® Study Continued

Results: Table 1. illustrates the Fortified Stimulate plant growth regulator and Charge humic acid combination offered yield gains of +13.2 Bu/A. applied in FurrowJet® center bands. Stand-alone applications of Harvest Plus in FurrowJet® wings resulted in yield gains of +4.6 Bu/A. Applying all three products offered the highest yield response in the study at +16.1 Bu/A.

Table 2. reveals the return on investment of all three products. Stand-alone Harvest Plus offered the lowest return in the study, but still realized some nice gains of +\$16.79/A. However, the FurrowJet® center applications of Fortified Stimulate and Charge resulted in a stellar return on investment of +\$54.42/A. When all three products were applied as a whole, net return tallied +\$62.71/A.



Planting Date: 5/10 Hybrid: Integra 6342 Population: 36K Row Width: 30" Rotation: CAB Corn Price: \$5.00

Fortified Stimulate: \$6.26/A. Charge: \$5.32/A. Harvest Plus: \$6.21/A.

Loveland Products RiseR® FurrowJet® Study

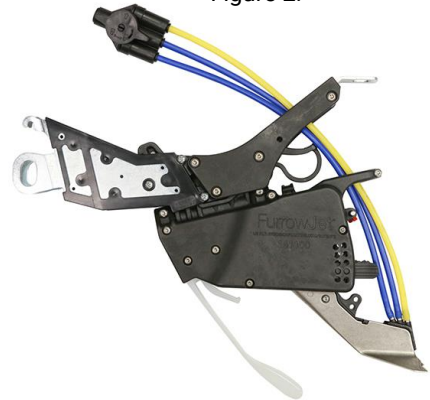
Objective: This tri-band FurrowJet® (Figure 2.) system application trial evaluates the yield and net return of RiseR, a 7-17-3 low salt, seed safe, pop-up in-furrow starter fertilizer containing Acetate® Technology.

Figure 1.

GUARANTEED ANALYSIS	
Total Nitrogen	7.00%
6.0% Ammoniacal Nitrogen	
0.3% Nitrate Nitrogen	
0.7% Urea Nitrogen	
Available Phosphate (P ₂ O ₅).....	17.00%
Soluble Potash (K ₂ O).....	3.00%
Copper (Cu).....	0.07%
0.07% Chelated Copper (Cu)	
Iron (Fe).....	0.20%
0.20% Chelated Iron (Fe)	
Manganese (Mn)	0.06%
0.06% Chelated Manganese (Mn)	
Zinc (Zn).....	0.95%
0.95% Chelated Zinc (Zn)	

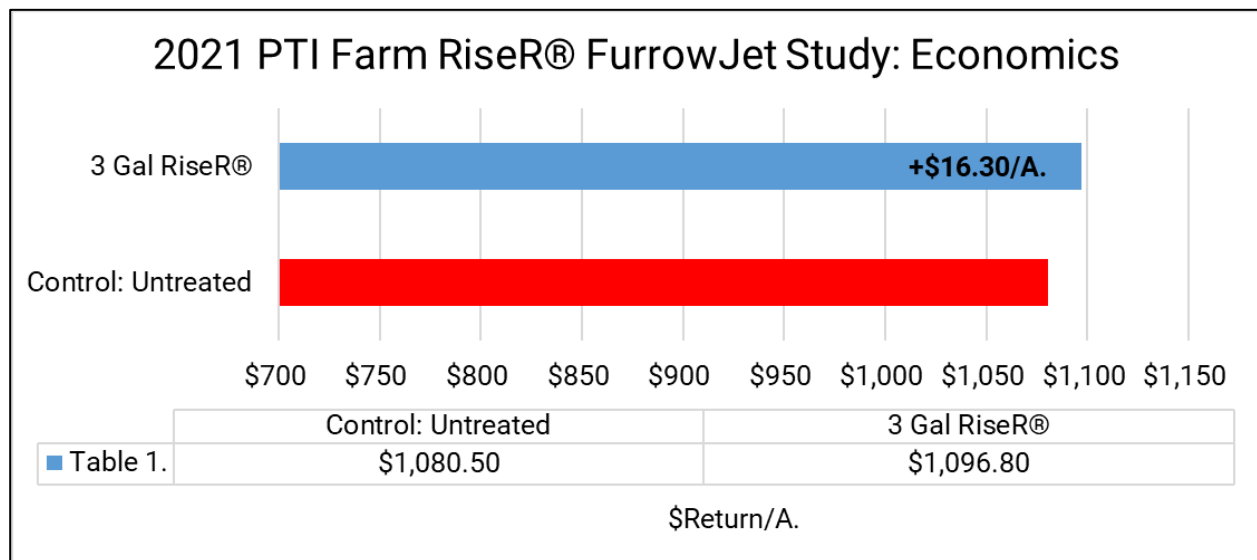


Figure 2.



Derived from: Urea Ammonium Nitrate, Ammonium Polyphosphate, Potassium Acetate, Zinc Oxide, Anhydrous Ammonia, Copper EDTA, Iron HEDTA, Manganese EDTA, and Zinc EDTA.
 EDTA is ethylenediaminetetraacetic acid. HEDTA is hydroxyethylethylenediaminetriacetic acid.

Results: RiseR treatments resulted in positive yield gains of +7.7 Bu/A. with a positive net return on investment of +\$16.30/A.



Ethos® XB FurrowJet® Study

Objective: This FurrowJet® system (Figure 2.) trial evaluates the yield and net return of Ethos XB, an insecticide/fungicide that combines the active ingredient of Capture LFR insecticide with a broad-spectrum bio-fungicide. This combination defends against insect pest such as corn rootworms, wireworms, grubs, seed corn maggots, cutworms, and common stalk borers. This also defends against diseases such as Fusarium, Pythium, Rhizoctonia and Phytophthora.

The bio-fungicide in Ethos XB insecticide/fungicide forms a protective barrier on root surfaces and builds over time as spores germinate and colonize roots and root hairs.

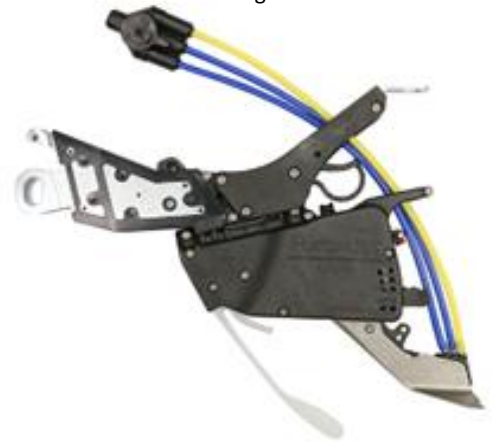
Results: Ethos XB treatments applied through FurrowJet® system offered positive yield gains of +8.7 Bu/A. (Table 1.) Four years of testing (2018-2021) has realized average yield gains of +8.2 Bu/A. along with an average return on investment of \$11.44/A.

Figure 1.

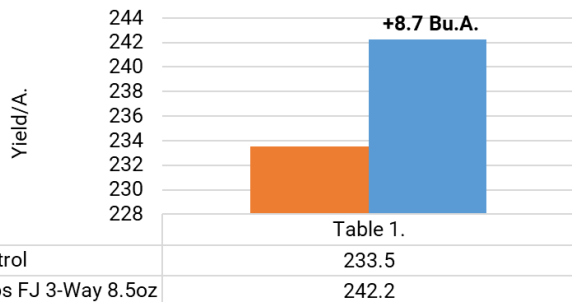
ACTIVE INGREDIENTS:	By Wt.
Bifenthrin *	15.67%
<i>Bacillus amyloliquefaciens</i> strain D747 **	5.00%
Other Ingredients.....	79.33%
Total:	100.00%

*Cis isomers 97% minimum, trans isomers 3% maximum
 ** Contains a minimum of 1x 10¹⁰ colony-forming units (cfu) per milliliter of product.
 This product contains 1.5 lbs bifenthrin per gallon.

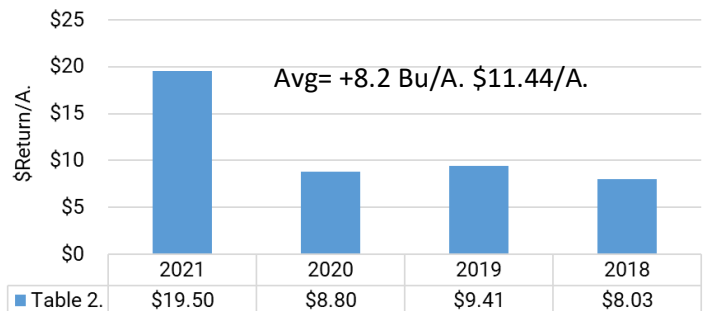
Figure 2.



2021 Ethos XB FurrowJet Study: Yield



2018-2021 Ethos XB FurrowJet Results: Economics



Capture® LFR® In-Furrow Study

Objective: This in-furrow application trial applied via FurrowJet® (Figure 2.) evaluates yield and economics of Capture® LFR®, an in-furrow liquid insecticide containing the active ingredient Bifenthrin (Figure 1.) in a liquid fertilizer ready (LFR) formulation.

Figure 1.

EPA Reg. No. 279-3302	EPA Est. 279-NY-1
Active Ingredient:	By Wt.
Bifenthrin*:	17.15%
Other Ingredients:	82.85%
	100.0%

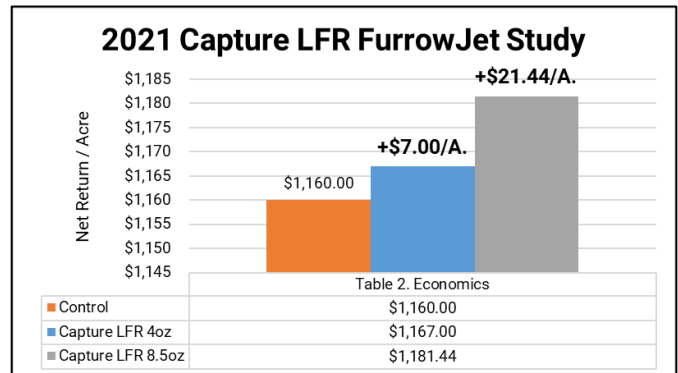
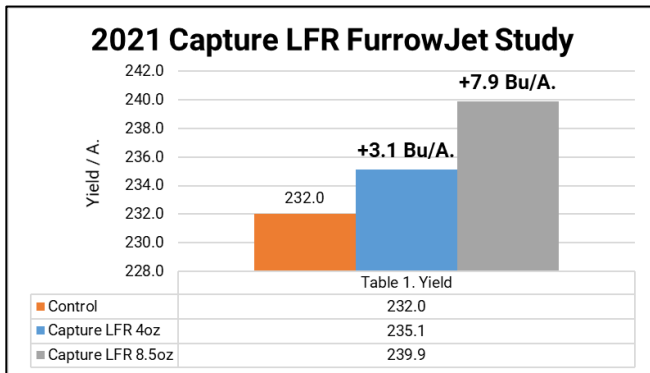
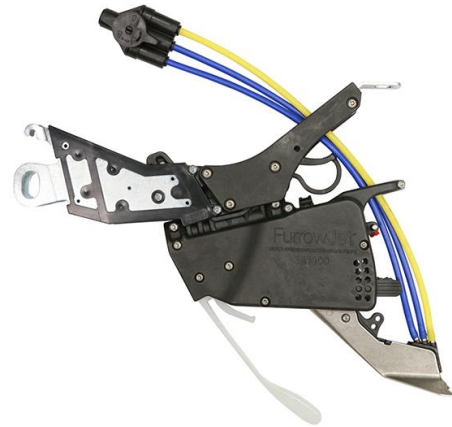
*Cis isomers 97% minimum, trans isomers 3% maximum.

This product contains 1.5 pounds active ingredient per gallon.

Capture LFR controls seed and seedling pests such as wireworm, corn rootworm, cutworm, grubs, armyworm, seed corn maggot and common stalk borer.

Results: The higher 8.5oz rate of Capture LFR offered the highest yield responses at +7.9 Bu/A., a 60% improvement over the lower 4oz/A. rate. However, both Capture LFR rates garnered positive economic advantages at +\$7/A. and +\$21.44/A. respectively.

Figure 2.



Xyway™ LFR® FurrowJet® Study

Objective: To evaluate the yield and economic return of Xyway LFR, a fungicide with the active ingredient Flutriafol (Figure 1). Xyway LFR fungicide is promoted as a revolutionary in-furrow fungicide formulation that provides season-long disease protection from the inside out, root to tassel and stalk to leaf.

This study evaluates Xyway LFR applied in various soil applied situations. First, Xyway LFR is evaluated as a in-furrow treatment applied through FurrowJet®, a planter fertilizer attachment that enables placement of fertilizer on the seed as well as 3/4" on each side of the seed (Figure 2-5). To achieve this dual-band placement, the wings on FurrowJet® system angle downward to cut into the sidewall and place fertilizer alongside the seed in a dual-band. By doing this, lifting and fracturing can occur that potentially could remove soil smearing or compaction created by disc openers.

In this study, Xyway LFR is evaluated in three different FurrowJet® placements consisting of:

FurrowJet® Center only (Figure 3.)

FurrowJet® Wings only (Figure 4.)

FurrowJet® 3-Way (Figure 5.)

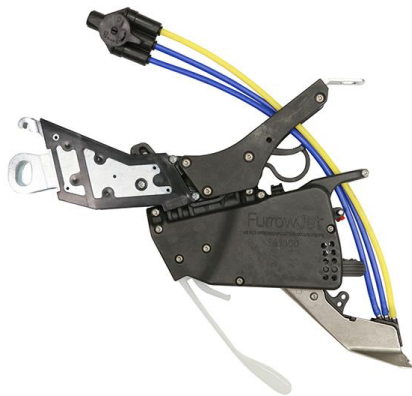


Figure 2. FurrowJet® In-Furrow Planter Attachment



Figure 1.

EPA Reg. No. 279-9638	EPA Est. No. 279-DE-001
Active Ingredient:	By Wt.
Flutriafol	26.4%
Other Ingredients:	73.6%
TOTAL:	100.0%

Contains 2.5 pounds per gallon of the active ingredient flutriafol. Suspension Concentrate.

Figure 3. FurrowJet® Center Only

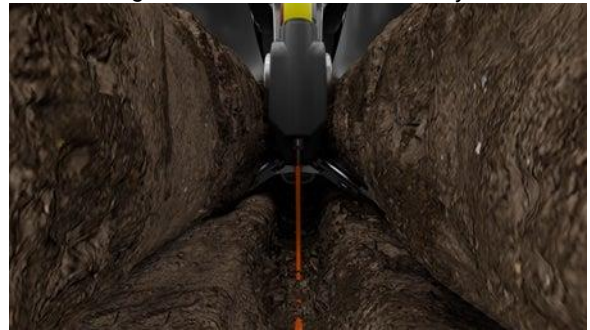


Figure 4. FurrowJet® Wings Only

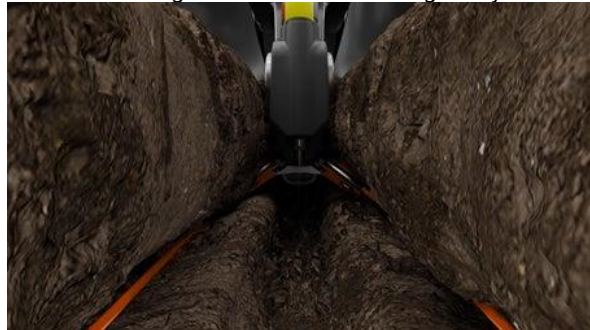
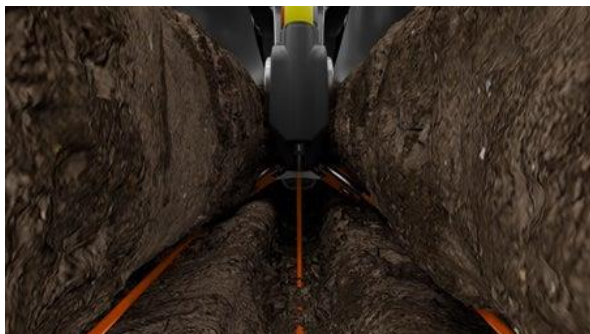


Figure 5. FurrowJet® 3-Way: Center and



Xyway™ LFR® FurrowJet® Study Continued

Secondly, to focus on applications of Xyway LFR further away from the seed, a fourth treatment was also evaluated with Conceal®. A Conceal® system is a unique planter attachment that allows growers to place product in a high concentration dual or single band positioned 3" away from the seed trench (Figure 7.) in depths near 1.5". The Conceal® system uses existing planter space, utilizing a backswept knife located with-in the center of the planter's gauge wheels (Figure 6). As product is applied, it is sealed within the soil profile by the gauge wheels.

Figure 6. Conceal® Knife Design within Gauge Wheel



Figure 7. Conceal® Dual Placement 3" from Seed Trench



2021 Xyway™ LFR® Soil Applied Placement Study: Yield

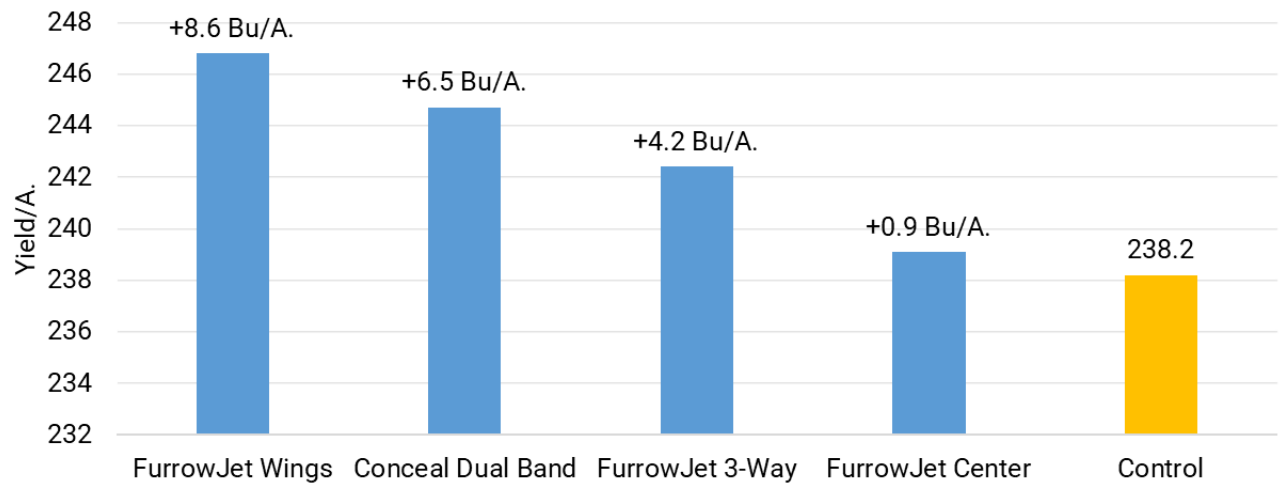
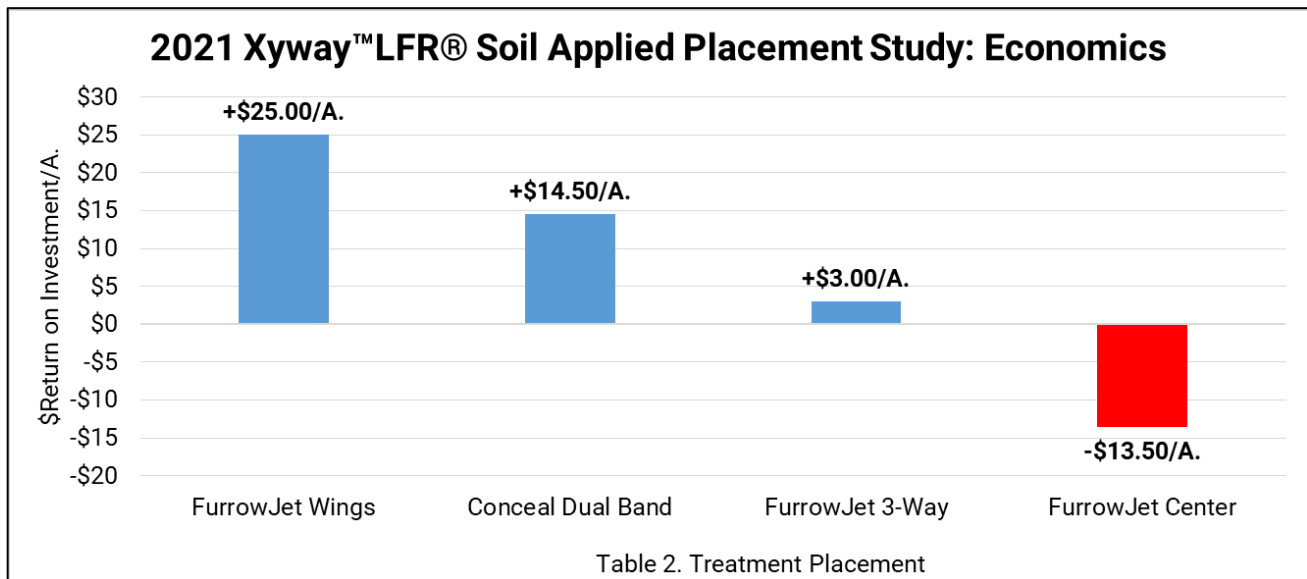


Table 1. Treatment Placement

Xyway™ LFR® FurrowJet® Study Continued

Results: Table 1. illustrates all treatments did in fact result in positive yield gains. However, Xyway LFR placed closest to the seed in-furrow resulted in the lowest yield gains in the study. As flutriafol treatments were placed closest to the seed via FurrowJet® center applications, yield gain was still realized, but only at 0.9 Bu/A. FurrowJet® wing applications, having 1/3rd of its application in the center, offered the 2nd lowest yield gain in the study at +4.2 Bu/A. Both these treatments resulted in an overall return on investment of **-\$13.50/A.** and +\$3.00/A. respectively (Table 2).

As flutriafol was placed outside of the seed trench, FurrowJet® wings offered the trial's highest yield gains at +8.6 Bu/A. and Conceal® placements resulted in gains of +6.5 Bu/A. These treatments resulted in an overall return on investment of +\$25/A. and \$14.50/A.



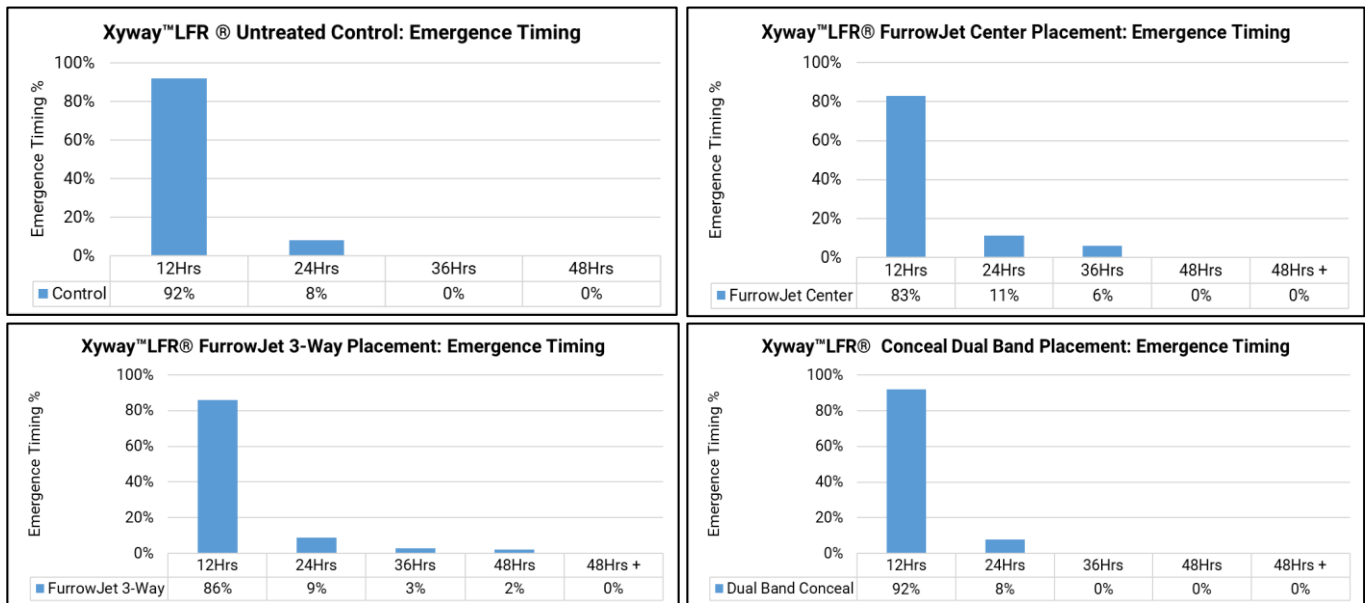
Xyway™ LFR® FurrowJet® Study Continued

To help understand why treatments of Xyway LFR applied closest to seed resulted in minimal yield response, the PTI team conducted flag emergence testing to help clarify and document differences in placements. The charts below illustrate the percentage of emergence timing at 12Hrs, 24Hrs, 36Hrs, 48Hrs, and anything after 48Hrs. The goal with emergence timing is to obtain the fastest emergence, which in this study is 12Hrs. PTI data has shown over the years that late or extended emergence timing past 12hrs can equal yield loss.

Emergence timing results indicate the untreated control posted 12Hr emergence at 92%, the highest of all scores in the study. FurrowJet® center applications of Xyway LFR resulted in 12Hr emergence of only 83%, a **-9%** reduction in early emergence. Consequently, 11% emerged late at 24Hrs and 6% as 36Hr emergers.

FurrowJet® wing treatments were slightly better, but it also has 1/3rd of the application as a near seed center placement. 12Hr emergence tallied 86%, which led to plants emerging later with 9% at 24Hrs, 3% at 36Hrs, and 2% at 48Hrs.

Conceal® dual band treatments, being the farthest away from the seed trench offered similar emergence scores as the untreated control at 92% 12Hr, 8% 24Hr, and 0% later emergers.



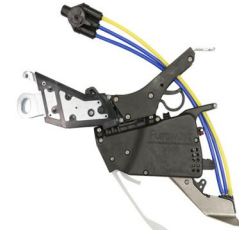
FurrowJet® Side-Wall Study

Objective: FurrowJet® is a planter fertilizer attachment (Figure 1.) that enables placement of not only an in-furrow starter fertilizer, but also a dual-band of fertilizer 3/4" on each side of the seed (Figure 2). To achieve this dual-band placement, the wings on FurrowJet® system angle downward to cut into the sidewall and place fertilizer alongside the seed in a dual-band. By doing this, lifting and fracturing can occur that potentially could remove soil smearing or compaction created by disc openers. (Figure 3.) Additionally, closing wheel systems following FurrowJet® wings have a better opportunity to close the seed trench, remove air pockets, and allow for good seed-to-soil contact.

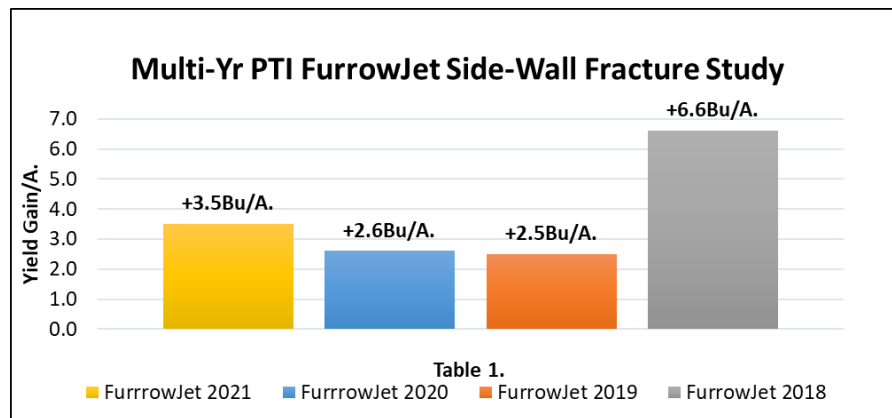
This study evaluates FurrowJet® dual-band wings offering the ability to cut, lift and remove side-wall compaction in the seed furrow. For this study, no liquid fertilizer was applied.

Results: Table 1. illustrates the side-wall fracture advantages of FurrowJet® system in the 2018 to 2021 growing seasons. While 2018 offered +6.6 Bu/A. advantages, 2019 to 2021 proved significantly less at only +2.5, +2.6 and +3.5 Bu/A. respectively. As mentioned in the objective, FurrowJet® systems do have the ability to assist in closing the furrow due to easier side-wall collapse. In 2019 -2021 our plot planter was fitted with a FurrowForce® system, a new robust automatic sensing and control closing wheel system. It is our belief that this system closed the gap on FurrowJet® system advantages due to superior closing activity. For growers using traditional single stage closing systems, FurrowJet® response could be more typical to 2018's yield response.

Figure 1. FurrowJet®

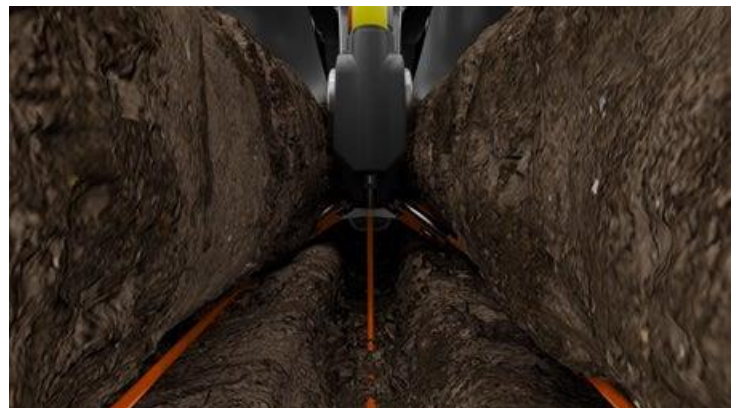
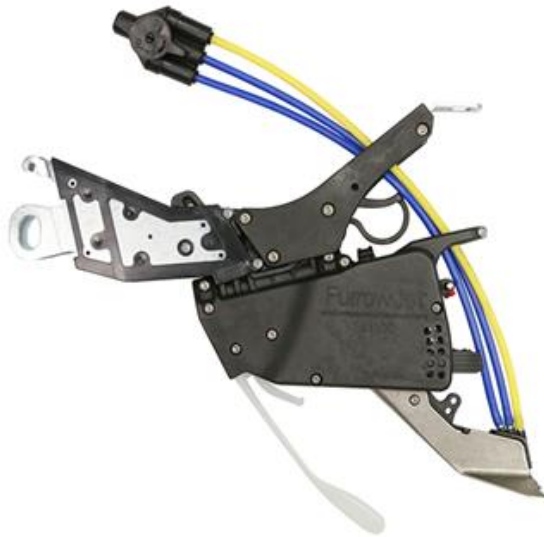


Figures 2-3: FurrowJet® Dual-Band Wings Fracturing Sidewalls



Corn Summary of 2021 FurrowJet® Applications

Study	Classification	Yield (Bu/A.)	\$ROI	Page #
Nachurs Start2 Finish Corn Fertility	Starter Fertilizer	16.9	\$ 73.76	77
Stoller USA FJ 3-Way Fortified Stimulate/Harvest Plus Tankmix	Starter Fertilizer	16.1	\$ 62.71	86-87
Corn Marco QuickGrow LTE 6 Gal	Starter Fertilizer	10.6	\$ 60.50	70
Nachurs High Yield FJ Wings	Starter Fertilizer	10.6	\$ 59.13	55-56
Corn Marco QuickGrow LTE 4 Gal	Starter Fertilizer	8.0	\$ 55.00	70
Stoller USA FJC 4oz Fortified Stimulate + 1qt Charge	Starter Fertilizer	13.2	\$ 54.42	86-87
Nachurs imPulse FurrowJet Tri-Band 4Gal corn	Starter Fertilizer	8.2	\$ 53.48	74-76
Nachurs imPulse FurrowJet Center 5Gal Corn	Starter Fertilizer	9.0	\$ 53.10	74-76
Andersons Corn Combo Treatment	Starter Fertilizer	13	\$ 51.64	71-72
Corn Marco QuickGrow LTE 8 Gal	Starter Fertilizer	9.6	\$ 48.00	70
Nachurs Corn Conceal K-Fuse 5Gal	Potassium	14.3	\$ 47.37	122
Nachurs imPulse FurrowJet Wings 6Gal Corn	Starter Fertilizer	8.1	\$ 44.22	74-76
Stoller USA Sugar Mover 32oz + Urea Mate 10#/100gal	Carbon Based Sugar+ Nitrogen	11.3	\$ 41.52	86-87
Nachurs High Yield FJ Center	Starter Fertilizer	4.6	\$ 37.91	55-56
Andersons 5Gal Season Pass 6-18-6 + Microcarb + 1pt BioPass FJC	Starter Fertilizer	8.5	\$ 36.50	71-72
AgroLiquid Starter Fertility Program Corn	Starter Fertilizer	11.2	\$ 31.30	73
Ocean Blue AG 160oz NutriShield + Full Program	Starter Fertilizer	37.5	\$ 28.81	59-60
Xyway LFR FJ Wings	Fungicide	8.6	\$ 25.00	91-94
Stoller USA Sugar Mover 32oz	Carbon Based Sugar	6.9	\$ 24.97	86-87
March 10th SB Plant Date w/Starter	Starter Fertilizer	4.2	\$ 23.50	164-165
10gal 10-34-0 FJ 3-Way over Conceal Dual Band	Starter Fertilizer	6.4	\$ 23.00	83
April 6th Corn Plant Date w/Starter	Starter Fertilizer	14.1	\$ 21.87	9-10
Pivot Bio PROVEN40 w/25% N Reduction FJC	Biological	4.0	\$ 20.16	78
QLF 7-21-3 FJ 3-Way 3Gal	Starter Fertilizer	0.5	\$ 20.01	85
L-CBF 7-21-3 MKP Corn FurrowJet 3 Gal	Starter Fertilizer	0.5	\$ 19.75	85
L-CBF 7-21-3 MKP Corn FurrowJet 5Gal	Starter Fertilizer	2.1	\$ 19.25	85
Corn FurrowJet Side Wall	Mechanical	3.5	\$ 17.50	95
Stoller USA FJW Harvest Plus 1qt	Micronutrient	4.6	\$ 16.79	86-87
Riser 3 Gal	Starter Fertilizer +Micronutrient	7.7	\$ 16.30	88
ProveN40 Applied by FurrowJet	Biological	3.2	\$ 16.00	79
Aqua-Yield NanoCS 3Gal/A. 7-21-3 50% Rate	Biological +Micronutrient	-5.3	\$ 13.75	80-81
NutriCharge 5Gal 7-21-3 + NutriCharge	Biological	3.4	\$ 12.62	82
L-CBF 7-21-3 MKP Corn FurrowJet 10 Gal	Starter Fertilizer	4.6	\$ 10.50	85
Xyway LFR FJ 3-Way	Fungicide	4.2	\$ 3.00	91-94
May 22nd Corn Plant Date w/Starter	Starter Fertilizer	9.3	\$ (2.00)	9-10
Xyway LFR FJC	Fungicide	0.9	\$ (13.50)	91-94
Ocean Blue AG 80oz NutriShield + Full Program	Starter Fertilizer	25.6	\$ (13.90)	59-60
Average		8.6	\$ 30.11	



Calcium Products™ SO4™ Study

Objective: This trial evaluates the yield response and economics of pelletized calcium sulfate (SO4) applied fall broadcast and as banded spring strip-till. Sulfur is an essential component of plant growth with key processes relying on chlorophyll formation and protein production. Sulfur is considered the fourth major nutrient behind N, P, and K.



CALCIUM PRODUCTS™



SO4 from Calcium Products is a 21% Calcium (non-pH neutralizing) and 17% Sulfur dry pelletized fertilizer, mined, and manufactured in NW Iowa. It is finely ground and pelletized to achieve a balance of solubility and pellet strength.

Historically, much of the sulfur need was satisfied with atmospheric deposition as result of coal burning industries. However, amendments to the Clean Air Act in 1990 targeted sulfur emissions, resulting in less than ½ of the amount of sulfur today compared to 30 years ago.

Results: Spring strip-till banded treatments of SO4 resulted in average yield gains of +7.9 Bu/A., with positive economic returns of +\$18.10/A.

Multi-year data from 2019, 2020, and 2021 has proven +7.1 Bu/A. yield gains with positive return on investment of +\$7.93/A.

Releases Sulfur to Match Plant Needs

SO4 supplies a balanced initial sulfur release and a steady supply throughout the growing season. AMS releases sulfur too quickly, and elemental sulfur releases sulfur too slowly, neither meeting the crop's complete needs.

Spreads Easily

SO4's consistent pellet size allows it to be blended and applied with other dry fertilizers, which means it doesn't require a separate application. It can be applied pre-plant in the spring, in-season via top dress or post-harvest in the fall.

Will Not Acidify Soil

SO4 is pH neutral, meaning it will not acidify the soil like other sulfur sources. Proper soil pH maximizes a plant's utilization of nutrients promoting good plant health and optimizing yield.

2021 PTI Farm SO4 Study: Yield

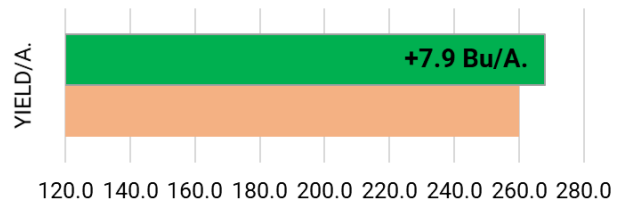


Table 1.

Spring Strip-Till 150# SO4	268.0
Control	260.1

2021 PTI Farm SO4 Study: Economics

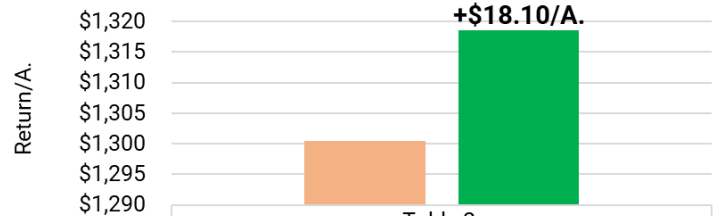


Table 2.

Control	\$1,300.50
Spring Strip-Till 150# SO4	\$1,318.60

Continuous Corn Cover Crop Study

Objective: This trial is designed to evaluate the yield and economic benefits of a cover crop system in a continuous corn rotation. To evaluate long-term benefits, this trial has been designed as a 10-year study. 45#/A. of cereal ryegrass was planted in the fall of 2020 and fall strip-till was used as the primary tillage system for corn. In the spring, corn was planted directly on the fall strips into the green cover crop. The ryegrass was terminated at V2.

Figure 1. Fall Cover Crop Seeding

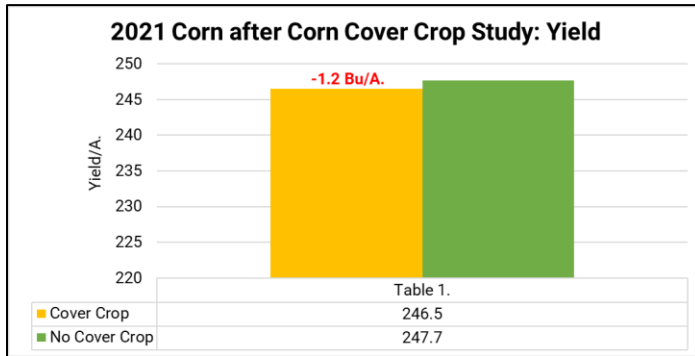
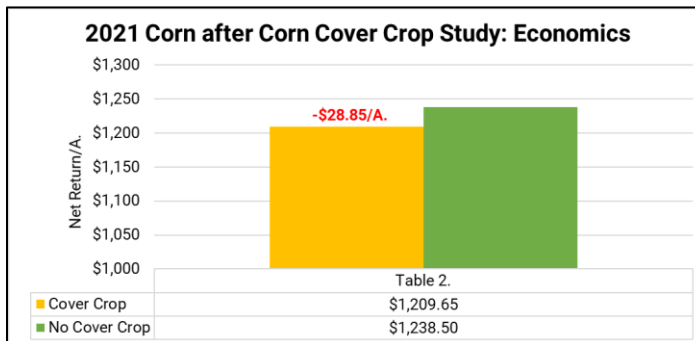


Figure 2. Planting into Strip-Till with Green Cover



Results: Continuous corn planted into our 1st year of our 10-yr study proved **-1.2 Bu/A.** yield losses compared to a non-cover crop system. Table 1. illustrates the near identical corn yield of the two systems.

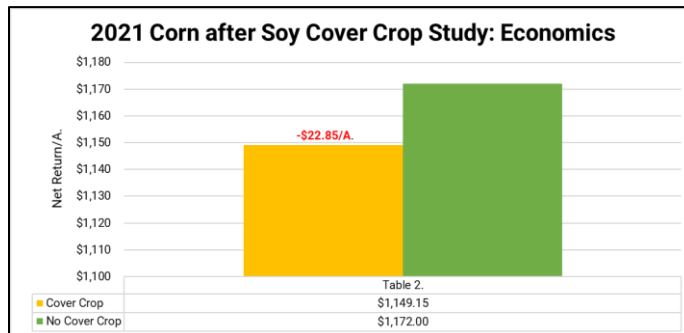
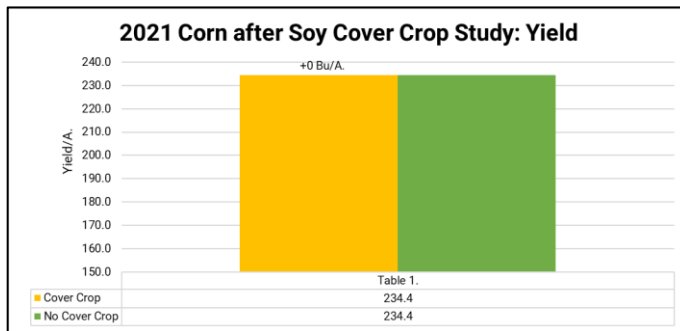
Due to the absence of yield gain, Table 2. depicts average losses of **-\$28.85/A.** for year 1 of our long-term study.

We look forward to continuing to test the use of cover crops in a continuous corn rotation and to evaluate yield, economics of the system, while taking a close look at what cover crops can offer regarding soil health improvement.

Corn after Soybean Cover Crop Study

Objective: This trial is designed to evaluate the yield and economic benefits of a cover crop system in a corn/soybean corn rotation. To evaluate long-term benefits, this trial has been designed as a 10-year study. 45#/A. of cereal ryegrass was planted in the fall of 2020 and fall strip-till was used as the primary tillage system for corn. In the spring, corn was planted directly on the fall strips into the green cover crop. The ryegrass was terminated at V2.

Figures 1-2. Planting into Strip-Till with Green Cover



Results: Corn planted into our 1st year of our 10-yr study proved identical yield compared to a non-cover crop system. (Table 1.) Both systems yielded 234.4 Bu/A.

Table 2. depicts average losses of **-\$22.85/A.** for the cover crop system in year 1 of our long-term study. We look forward to continuing to test the use of cover crops in a corn/soybean rotation and to evaluate yield, economics of the system, while taking a close look at what cover crops can offer regarding soil health improvement.

30" vs 20" Corn Study

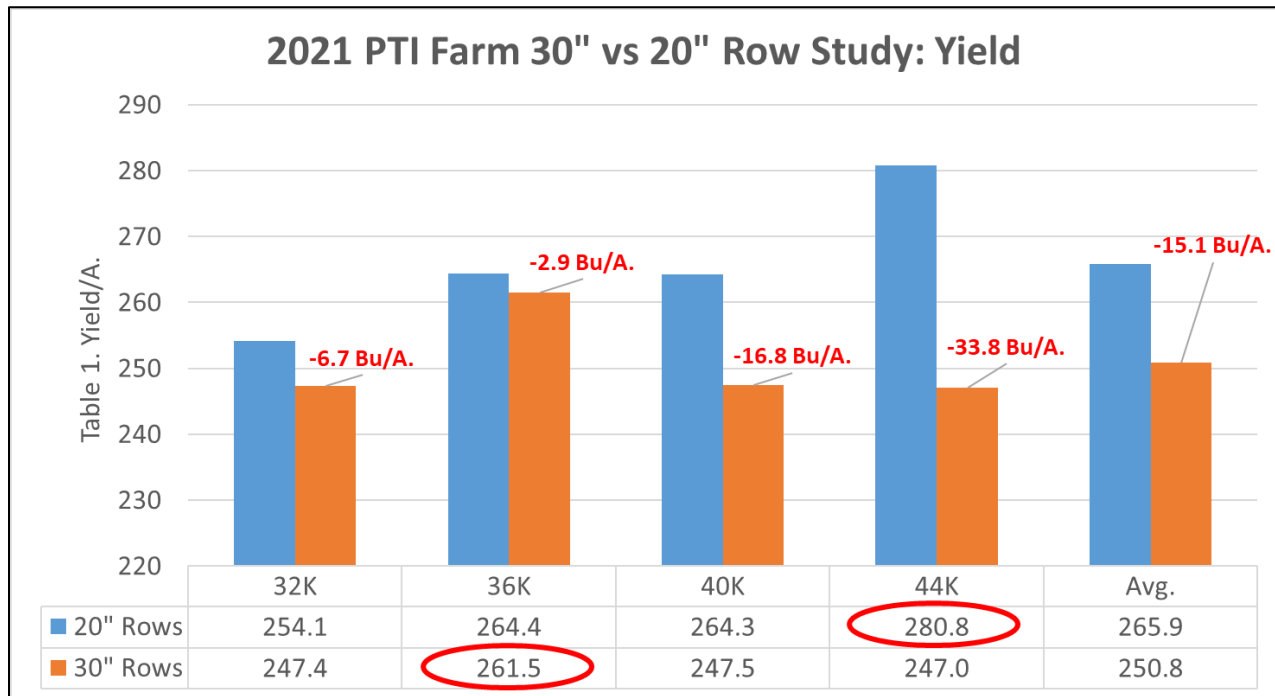
Objective: This trial evaluates the industry wide standard of 30" row corn, to a 20" narrower system at four seeding rates of 32K, 36K, 40K, and 44K. Four hybrids consisting of Dekalb 64-64, Integra 6061, Golden Harvest 10D21, and Pioneer 0924Q are used in this study to help identify differences in plant type response.

Results: Table 1. illustrates that 20" row corn out-yielded every individual 30" row entry, by a range of +2.9 to +33.8 Bu/A.

Between the lower 32K to 36K seeding rates, there was less than a 2.9 to 6.7 Bu/A. spread. As seeding rates went above 36K, huge yield gains occurred for 20" rows of +16.8 to +33.8 Bu/A., indicating too much plant-to-plant competition for 30" rows at these high rates in wide rows.



30" rows achieved highest yields at the 36K seeding rate, while 20" at the 44K seeding rate, and needed higher seeding rates to confirm agronomic optimum seeding rate.



30" vs 20" Corn Study Continued

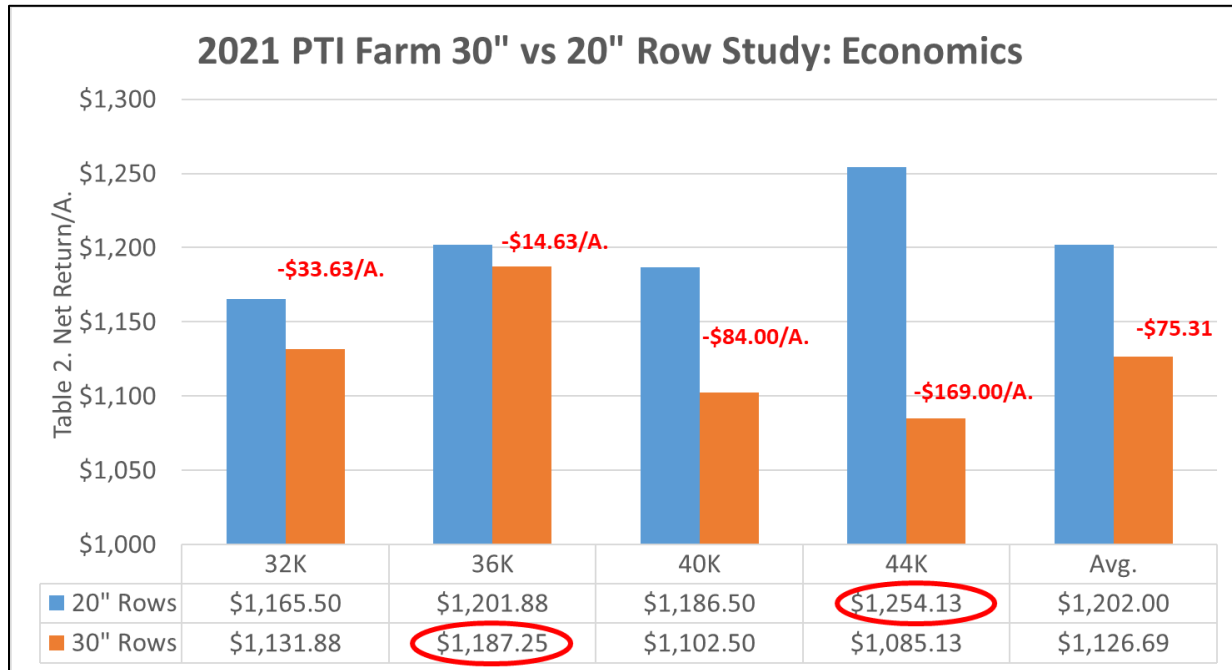
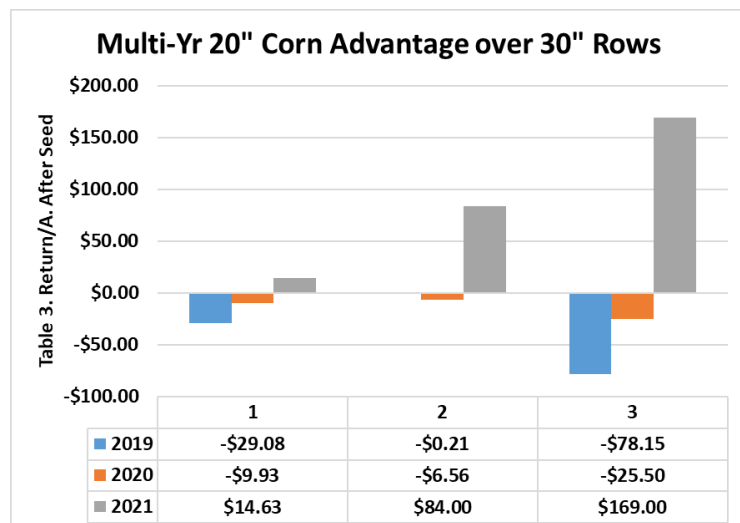


Table 2. illustrates that 20" rows also out-performed all individual 30" row entries in regard to economics. After cost of seed, 30" rows resulted in lower economic returns ranging from **-\$14.63** to **-\$169.00/A.**

30" row economic optimum seeding rate occurred at 36K, while 20" rows could not be established, due to the fact that yield kept improving at higher seeding rates.

2021 was an exceptional year for 20" rows. However, the challenge at the PTI Farm with 20" narrow corn, has been the lack of consistent economic profit. Table 3. illustrates multi-year (2019-2021) results of the advantage of 20" vs 30" rows at seeding rates of 36K, 40K, and 44K. All seeding rates in both 2019 and 2020 resulted net losses for 20" rows, while 2021 is the only year where 20" rows resulted in economic gains.

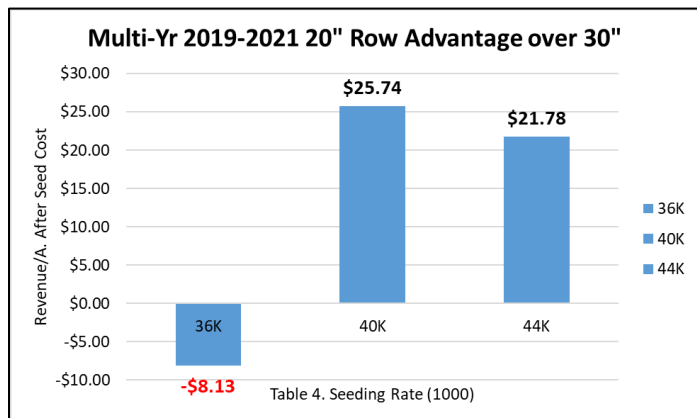


30" vs 20" Corn Study Continued

Each year we have thousands of growers that come to the PTI Farm to have a conversation about agronomics. One question we talk about often is corn row width. Many farms today that are on 30" corn rows, say they switched from wide 38" or 36" wide rows back in the early 70's. If this is the case, growers have been implementing 30" row corn systems for nearly 50 years. The question now is, has 50 years been long enough doing the same thing over and over, or is time now for a change to another system that could offer higher yields and profitability?



The question comes down to this; What revenue gain would cause a farmer to run to their local equipment dealer and convert their planters, harvest equipment, tractor tires, side-dress equipment, or even over-all management to narrow rows? Table 4. illustrates 20" rows average +\$21.78 to \$25.74/A. over 30" rows at seeding rates of 40K to 44K. Is this enough to get growers to convert? This is why many feel the adoption rate of narrow corn rows has been slow.



2021 was an outstanding year for 20" narrow rows and we are excited to see it continue in the future. However, until more corn hybrids are designed and created to excel in narrow rows, 20" and 15" rows may likely continue to be slow to adopt, especially if seeding rates stay near 36K.

Conversely, farm operations that could be a nice fit for narrow rows are:

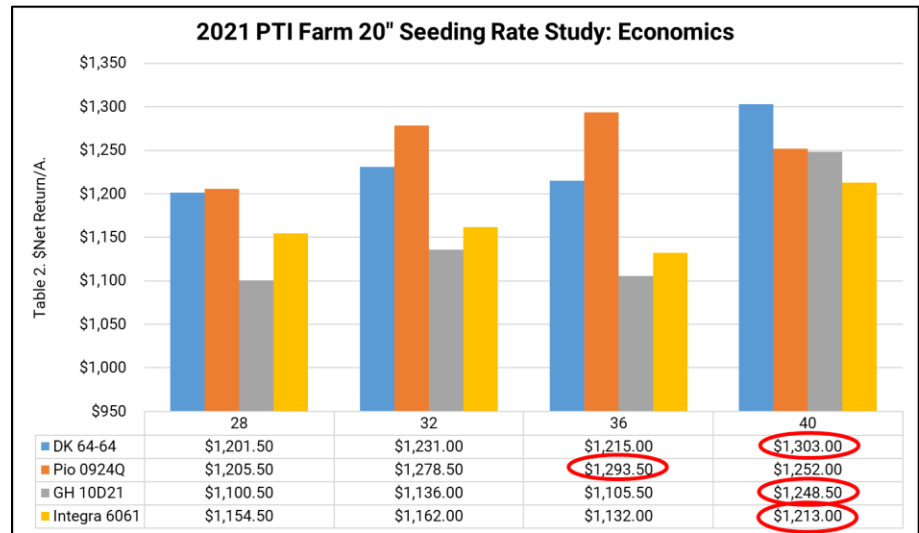
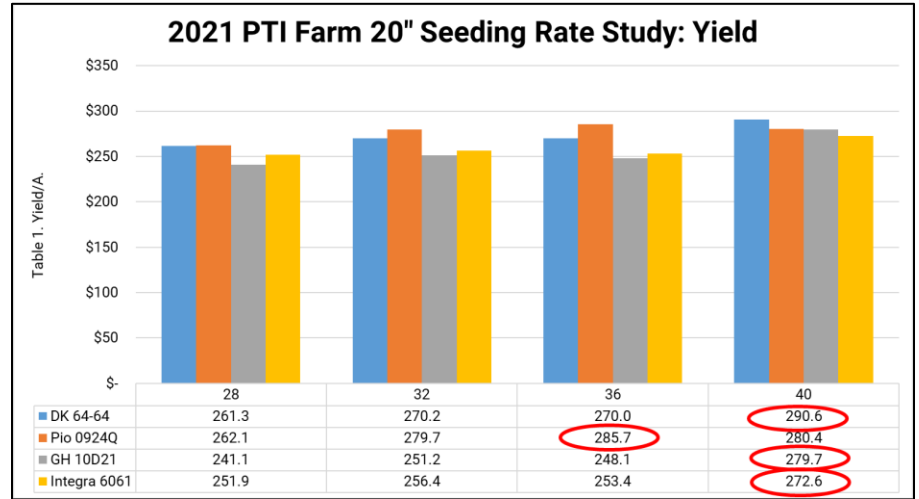
1. Producers on marginal ground where plant-to-plant competition could be important to conserve water and nutrients.
2. Growers who want to plant at higher seeding rates (above 36-38K) in the effort to "unlock" yield. At these higher pops, 30" rows are not appropriate and would fail.
3. Growers who want one planter that will also plant soybeans or another crop that prefers to be in narrow rows.

20" Row Corn Seeding Rate Study

Objective: This trial evaluates four seeding rates of 28K, 32K, 36K, and 40K, in a 20" narrow row corn environment. Four hybrids consisting of Dekalb 64-64, Integra 6061, Golden Harvest 10D21, and Pioneer 0924Q are used in this study to help identify differences in plant type response.

Results:

1. Dekalb 64-64 achieved agronomic yield at the highest 40K seeding rate. Yields varied by 29.3 Bu/A. across all seeding rates with 28K the lowest yield. Economic optimum seeding rate occurred at 40K with the highest yield in the study at 290.6 Bu/A.
2. Pioneer 0924Q achieved agronomic yield at the 36K seeding rate. Yields varied by 23.6 Bu/A. across all seeding rates with 28K being the lowest yield. Economic optimum seeding rate occurred at 36K.
3. Golden Harvest 10D21 achieved agronomic yield at the 40K seeding rate. Yields varied 38.6 Bu/A. across all seeding rates with 28K the lowest yield. Economic optimum seeding rate also occurred at 40K.
4. Integra 6061 achieved agronomic yield at the 40K seeding rate. Yields varied 20.7 Bu/A. across all seeding rates with 28K the lowest yield. Economic optimum seeding rate occurred at 40K.

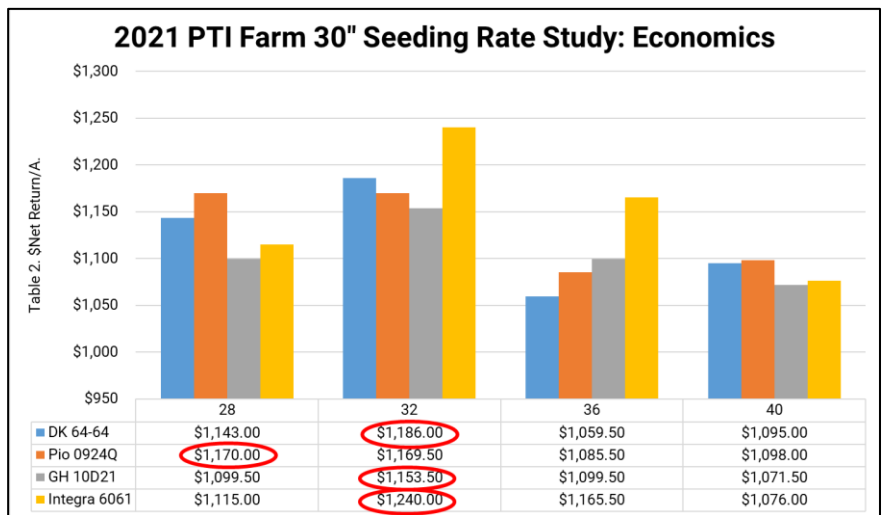
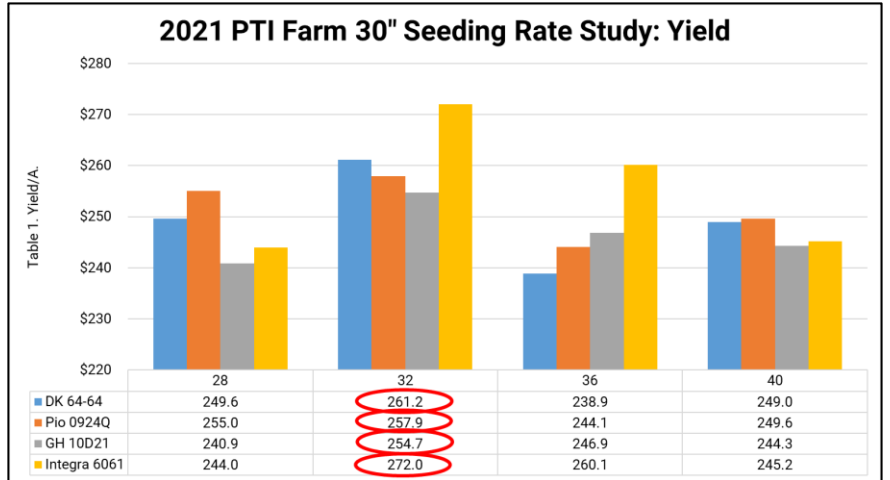


30" Row Corn Seeding Rate Study

Objective: This trial evaluates four seeding rates of 28K, 32K, 36K, and 40K, in a 30" wide row corn environment. Four hybrids consisting of Dekalb 64-64, Integra 6061, Golden Harvest 10D21, and Pioneer 0924Q are used in this study to help identify differences in plant type response.

Results:

1. Dekalb 64-64 achieved agronomic yield at the 32K seeding rate. Yields varied by 22.3 Bu/A. across all seeding rates with 36K the lowest yield. Economic optimum seeding rate also occurred at the 32K.
2. Pioneer 0924Q achieved agronomic yield at the 32K seeding rate. Yields varied by 13.8 Bu/A. across all seeding rates. Economic optimum seeding rate occurred at 28K.
3. Golden Harvest 10D21 achieved agronomic yield at the 32K seeding rate. Yields varied 13.8 Bu/A. across all seeding rates. Economic optimum seeding rate occurred at 32K.
4. Integra 6061 achieved agronomic yield at the 32K seeding rate. Yields varied by 28.0 Bu/A. across all seeding rates with 32K the lowest yield. Economic optimum seeding rate occurred at 32K.



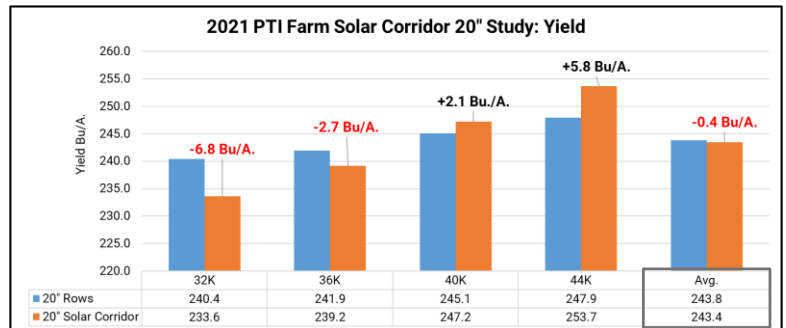
20" Solar Corridor Study

Objective: This trial's intention is to evaluate any yield or economic advantage in planting 20" row corn in a "solar corridor twin" method at seeding rates of 32K to 44K. A solar corridor is designed as 40" wide rows surrounded by two 20" rows. The theory behind this trial is to increase the distribution of sunlight so that all corn leaves or chloroplasts (regardless of their vertical disposition on the corn plant) receive full access to sunlight the entire growing season. If one of the basic principles of corn yield is maximizing sunlight, could a solar corridor ultimately contribute to increased yield?

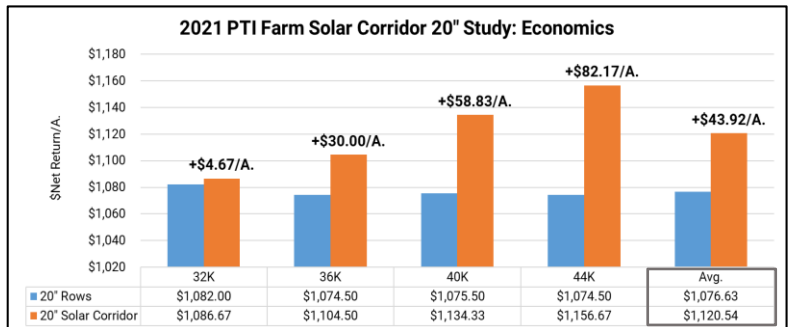


Results:

The solar corridor system resulted in average yield losses of **-0.4 Bu/A.**, however economic gains of **+\$43.92/A.** compared to traditional 20" rows over all seeding rates. Both systems achieved highest agronomic yield at 44K seeding rates.



At lower 32-36K seeding rates, solar corridor rows fell in yield by **-2.7 and -6.8 Bu/A.** However, due to lower seed cost (1/3rd of rows shut-off) these yield still offered economic gains of **+\$4.67 to +\$30.00/A.**

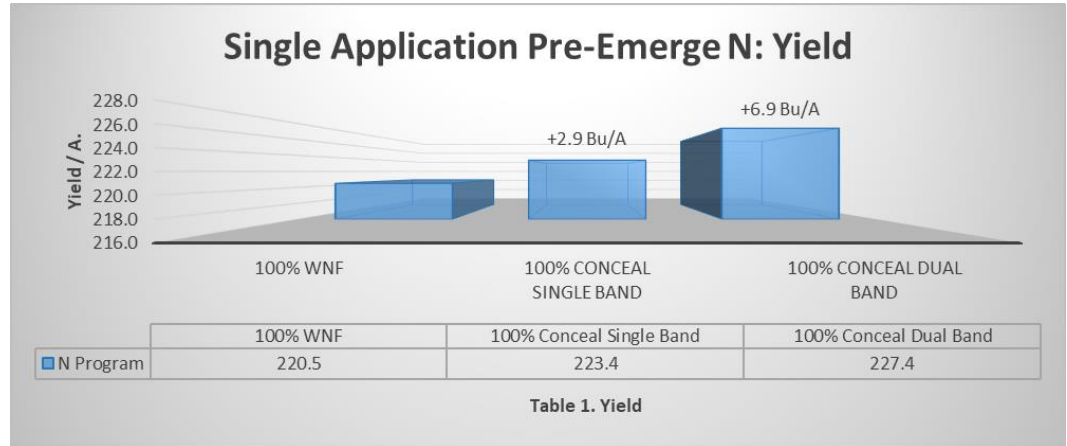


At the higher seeding rates, the solar corridor system paid big dividends with yield gains of **+2.1 to +5.8 Bu/A.** and associated additional revenue of **+\$58.83 to +\$82.17/A.**

2019 data resulted in average yield losses of **-9.7 Bu/A.**, however economic gains of **+\$5.92/A.** for the solar corridor system. 2020 resulted in **-17.4 Bu/A.** losses with **-\$21.43/A.** decreased revenue.

Single Application Pre-Emerge Nitrogen Study: Conceal® vs. Weed-N-Feed 100%

Objective: To compare 100% single applications of surface applied broadcast Weed-N-Feed (WNF) 32% UAN treatments to Conceal® system single and dual band at-plant nitrogen applications. Conceal® system is a unique planter attachment that allows growers to place nitrogen in a high concentration dual or single band positioned 3" away from the seed trench in depths near 1.5" (Figure 2). The Conceal® system uses existing planter space, utilizing a backswept knife located with-in the center of the planter's gauge wheels (Figure 1). As nitrogen is applied, it is sealed within the soil profile by the gauge wheels, preventing potential volatilization losses that is typically problematic with surface type nitrogen applications.



Results: Table 1. illustrates that Conceal® system dual band applications of nitrogen out-yielded traditional 100% WNF by +6.9 Bu/A., while Conceal® system single band treatments out-performed the same by +2.9 Bu/A.

In summary, planter applied nitrogen equated to additional revenue gains over WNF applications by +\$14.50/A. and +\$34.50/A.

Figure 1. Conceal® System Knife Design within Gauge Wheel

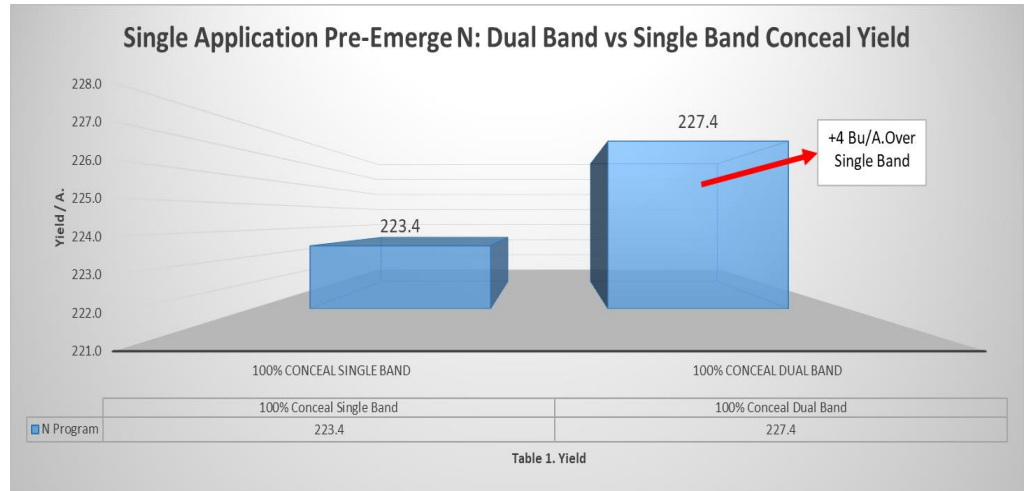


Figure 2. Conceal® Dual Placement 3" from Seed Trench



Single Band vs. Dual Band Conceal® Nitrogen Study

Objective: To compare dual band versus single band applications of nitrogen in an at-plant scenario using Conceal®. Both treatments consist of 50% of 225lbs total nitrogen at planting and the remaining 50% in a V6 side-dress, all using UAN 32%.

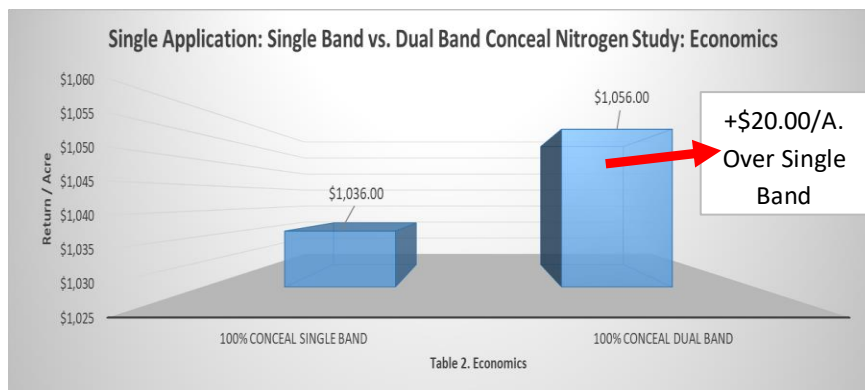


A Conceal® system is a unique planter attachment that allows growers to place nitrogen in a high concentration dual or single band positioned 3" away from the seed trench (Figure 1.) in depths near 1.5". If corn is planted at a 2" depth, Conceal® system fertilizer placement is 3X-0.5X1 in single bands and 3X-0.5X2 in dual bands.

Conceal® uses existing planter space, utilizing a backswept knife located within the center of the planter's gauge wheels (Figure 1). As nitrogen is applied, it is sealed within the soil profile, preventing potential volatilization losses typically seen with surface type nitrogen applications.

Results: Table 1. illustrates that dual band applications of nitrogen out-yielded single band applications by +4.0 Bu/A. These yield gains consequently equated to additional net returns of +\$20.00/A. (Table 2).

Figure 1. Conceal® Single or Dual Placement 3" from Seed Trench, 1.5" in Depth



Planting Date: 5/2

Hybrid: GH 10D21

Population: 36K

Row Width: 30"

Rotation: CAB

Corn Price: \$ 5.00

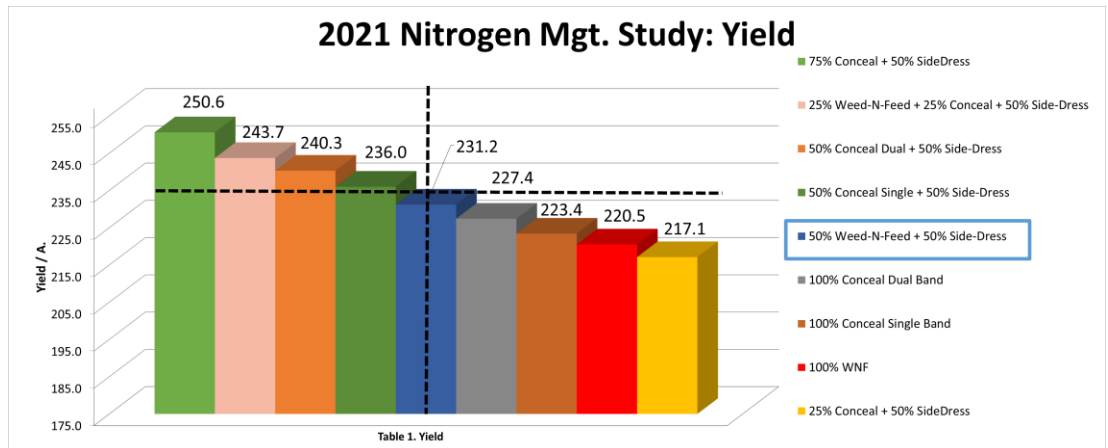
Conceal® Nitrogen Rate/Placement Study

Objective: This corn study evaluates the performance of nine different nitrogen rate and placement programs. These nine programs consist of single one and done nitrogen programs, 2-way split applications, and even 3-way split programs. All treatments are applied using 32% UAN liquid nitrogen. As a baseline, the 50% WNF + 50% V6 Side-Dress (Treatment #4) is facilitated as the control for this trial.

1.	100% Weed-N-Feed (WNF):	180# N as Surface applied 32% UAN	Single Applications
2.	100% Conceal® Single Band:	180# N with Conceal® Single N Band 1.5" Deep	
3.	100% Conceal® Dual Band:	180# N with Conceal® Dual N Bands 1.5" Deep	
4.	50% WNF+50% Side-Dress:	90# N WNF+ 90# N V6 side-dress: "Control"	Dual Split Applications
5.	50% Conceal® Single Band+50% Side-Dress:	90# N Conceal® Dual Bands + 90# N V6 Side-Dress	
6.	50% Conceal® Dual Band+50% Side-Dress:	90# N Conceal® Dual Bands + 90# N V6 Side-Dress	
7.	25% Conceal® Dual Band+50% Side-Dress:	45# N Conceal® Dual Bands + 90# V6 Side-Dress	
8.	75% Conceal® Dual Band+50% Side-Dress:	135# N Conceal® Dual Bands + 90# N V6 Side-Dress	Triple Split Applications
9.	25% Conceal®+25%WNF+50% Side-Dress:	45# N WNF + 45# N Conceal® Dual Bands + 90# V6 Side-Dress	

Results: Table 1. illustrates the overall yield results of all nine nitrogen programs. All three single applications of nitrogen (Treatments 1-3), along with the -25% reduced rate treatment, proved the lowest performances in the study. This has been the typical trend at the PTI Farm over the last few years.

The 125% nitrogen rate treatment (75% Conceal® Dual Band+50% Side-Dress) resulted in the highest yields at 250.6 Bu/A. Dual nitrogen programs (Programs 4-8) out-yielded single N programs (1-3) by +11.3 Bu/A. The triple N program (Program 9) out-yielded singles by +19.9 Bu/A. and beat dual programs by +8.7 Bu/A.



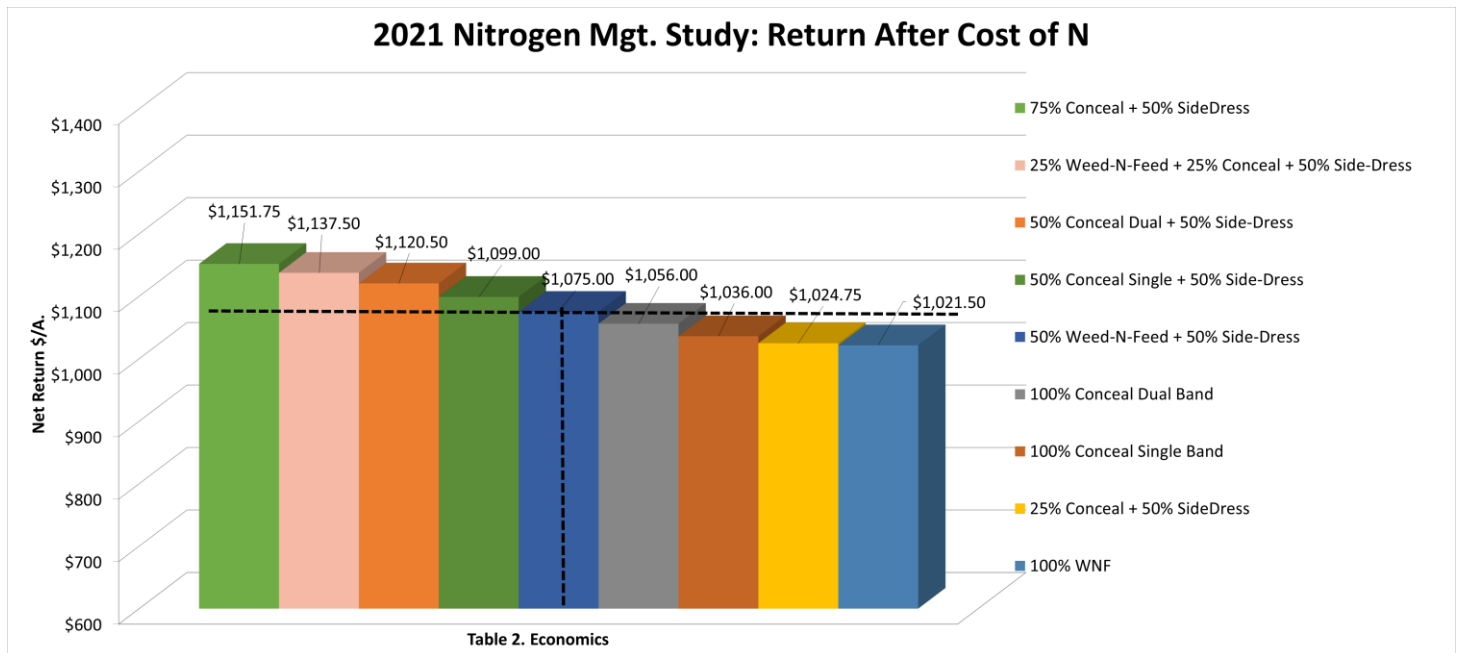
Conceal® Nitrogen Rate/Placement Study Continued

Table 2. continues the story by calculating net return after cost of nitrogen. The top nitrogen program for 2021 was the +25% over-application program (Treatment #8) that resulted in an incredible +\$130.25/A. increase over the lowest return application, a one and done Weed-N-Feed.

To help understand the efficiency of the applications, we evaluated adjusting nitrogen rate by +25% and -25%. Adding 25% more nitrogen was not only the overall highest yielding treatment in the study at 250.6 Bu/A., but also resulted in the highest overall net return after the cost of N. In this continuous corn study, it was apparent that higher rates of nitrogen were needed for optimum production and economics.

Lowering nitrogen rate by 25% turned out to be detrimental, as yields suffered **-33.5 Bu/A.** along with decreased returns of **-\$127/A.** compared to the +25% over-application. Please note this 25% reduced rate of N, albeit a dual split application of 25% planter applied N and a 50% side-dress, still offered +\$3.25/A. above the single application 100% WNF rate of N.

Single application programs resulted in the largest losses in this study, with WNF suffering the largest losses of the group.



Nitrogen Management Rate/Placement Study Continued

Table 3. helps clarify the yield advantages of split applications of nitrogen compared to a one and done WNF application. Adding a dual application side-dress treatment in addition to a WNF program, offered +10.7 Bu/A. yield advantages.

If we take this one step further, adding a planter applied application (triple split) offered even higher yields at +23.2 Bu/A.

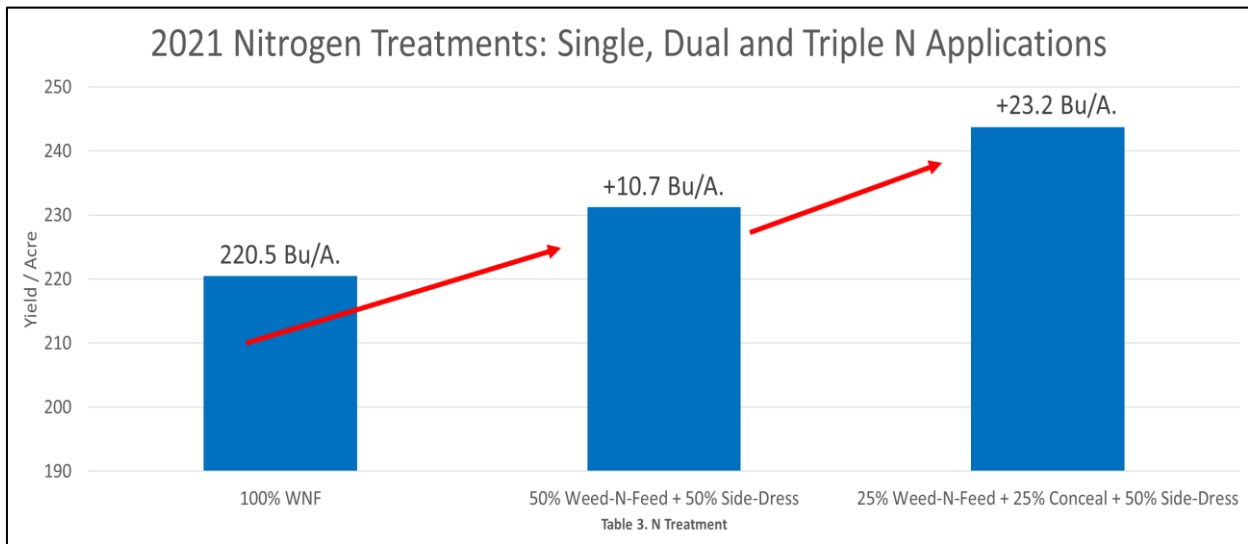


Figure 1. Weed-N-Feed Nitrogen



Figure 2. Conceal At-Plant Nitrogen



Figure 3. Side-Dress Nitrogen

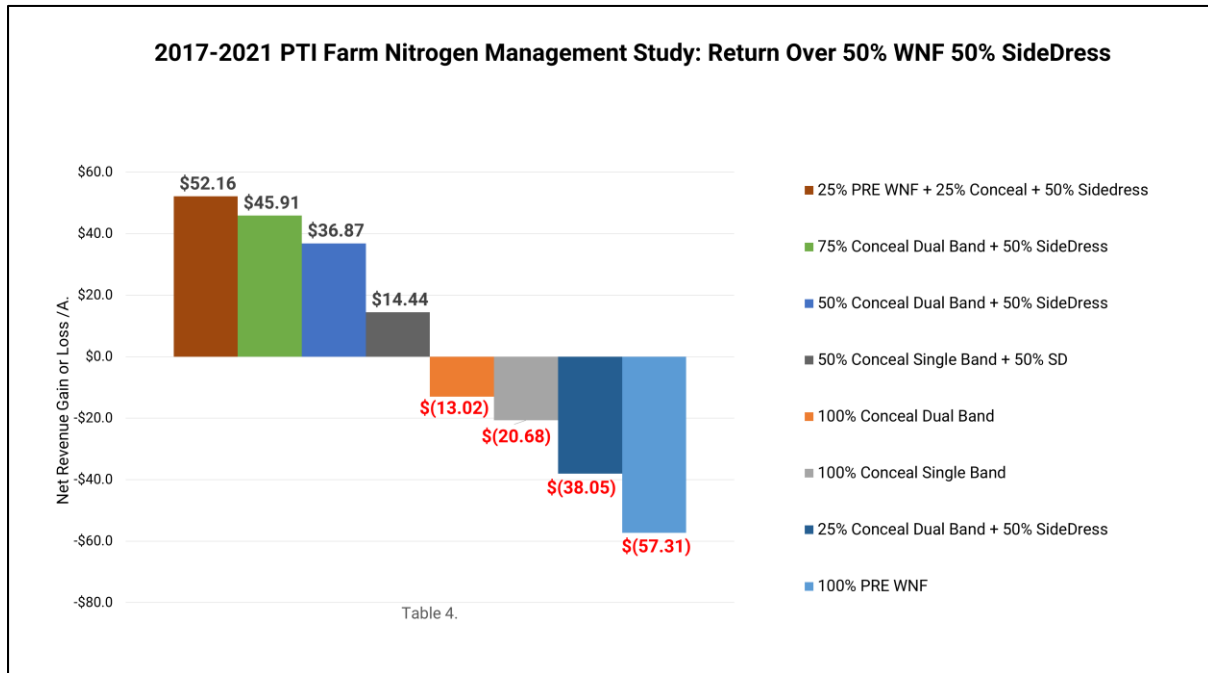


Nitrogen Management Rate/Placement Study Continued

Table 4. illustrates multi-year data from 2017-2021 and the net return associated with each nitrogen program used over the past five growing seasons. Over this time, the triple application of 25% WNF + 25% Dual Band Conceal® + 50% Side-dress has taken top honors at +\$52.16/A. compared to the control treatment of the 50% WNF plus 50% side-dress.

The 125% over-application treatment proved a 2nd place finish at +\$45.91/A. 50% Conceal® dual band + 50% side-dress resulted in a 3rd place finish with economic gains of +\$36.87/A.

All treatments that revealed net losses consisted of either single applications or the 25% reduction of nitrogen. These nitrogen applications suffered losses ranging from **-\$13.02/A.** to **-\$57.31/A.**



L-CBF BOOST™ 4-0-3-2S Nitrogen Inclusion Study

Objective: To evaluate yield, net return, and nitrogen use efficiency (NUE) of QLF® Agronomy's Liquid Carbon-Based Fertilizer (L-CBF) BOOST 4-0-3-2S added to UAN 32% applied through a Conceal® dual band (Figure 1.) application system.

BOOST is a concentrated source of available carbon in a low pH chemistry package. Derived of a cane molasses-based product (30% sugar) with a fermentation yeast extract, BOOST also contains chemistry designed to stimulate biological activity and enhance nutrient cycling in soils. Since BOOST™ works symbiotically to directly support the health and productivity of the soil by feeding soil microbes and assisting with nutrient cycling, this study specifically evaluates the ability of BOOST to act as nitrogen inclusion additive to aid in NUE.

For this study, a 10% nitrogen inclusion rate is evaluated compared to 100% rates of nitrogen (N) with and without BOOST:

Control: 100% N: 25 Gal/A. 32% UAN At-Plant Dual Band Conceal® followed by 25 Gal/A. 32% UAN V4 Side-Dress

10% N Reduction: 20 Gal/A. 32% UAN At-Plant Dual Band Conceal® followed by 25 Gal V4 Side-Dress (5 Gal/A. reduction)

10%BOOST Inclusion: 20 Gal/A. 32% UAN + 2.5 Gal/A. BOOST At-Plant Dual Band Conceal® followed by 22.5 Gal 32% UAN + 2.5 Gal/A. BOOST V4 Side-Dress

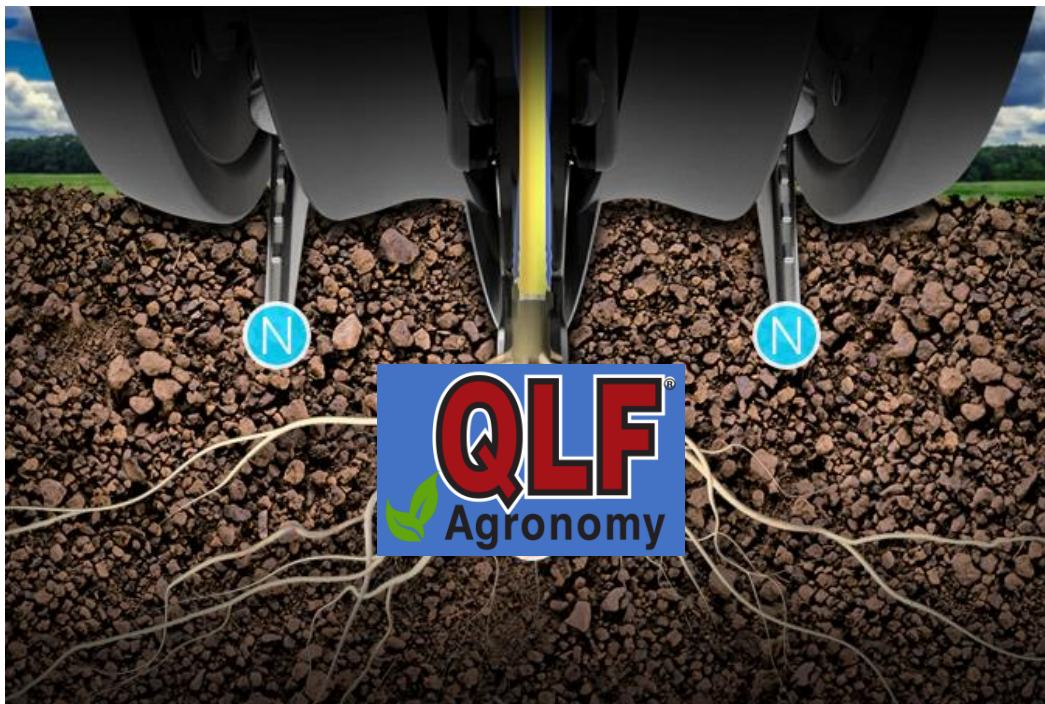
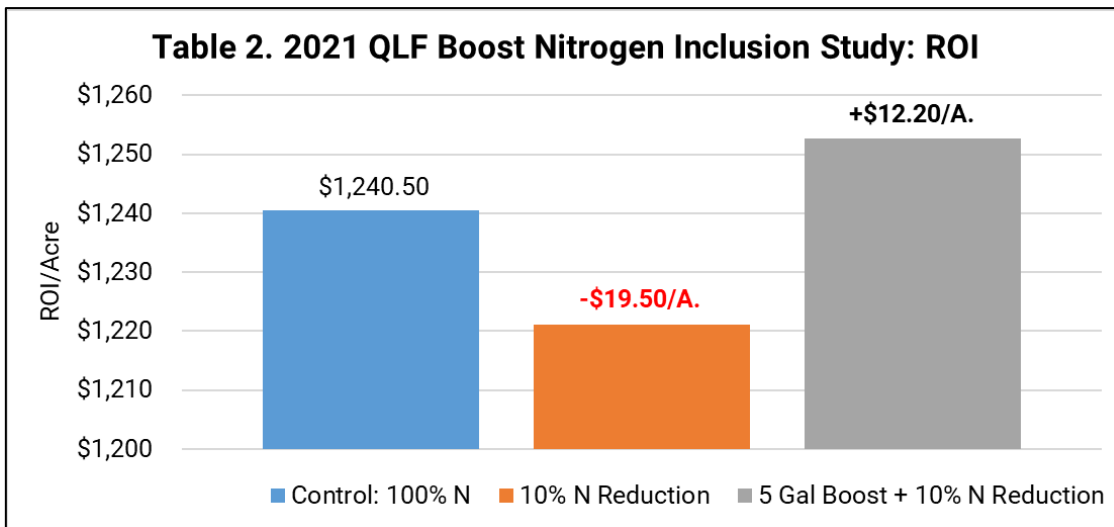
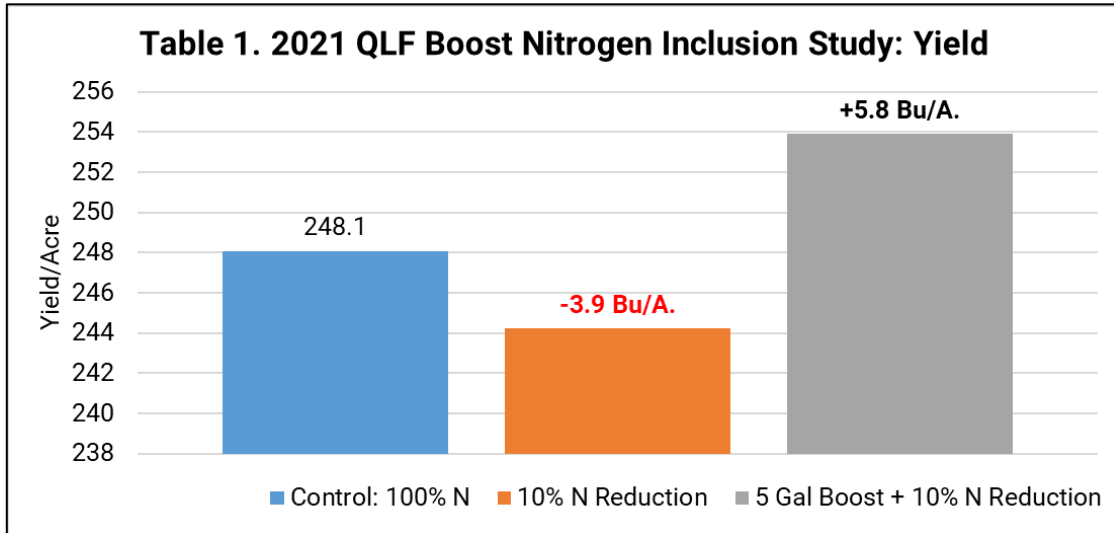


Figure 1. Conceal® dual band nitrogen placement 3" away from seed furrow 1.5"

L-CBF BOOST™ 4-0-3-2S Nitrogen Inclusion Study Continued

Results: Tables 1-2. illustrate reducing total nitrogen by 10% resulted in yield losses of **-3.9 Bu/A.** and net economic losses of **-\$19.50/A.** However, BOOST inclusion treatments increased corn yield by +5.8 Bu/A., while realizing a positive return on investment of +\$12.33/A.

This year-one study reflects efficiencies gained with the BOOST inclusion, ensuring a better recovery of UAN 32% investment delivered through the Conceal® dual band system.



Dribble vs Conceal® Nitrogen Study

Objective: To evaluate and compare yield and economic impact of at-plant applications of nitrogen placed in both dual band dribble and Conceal® system at-plant treatments. Dual Band dribble applications are made by liquid lines dribbling the fertilizer right behind the closing system.

Figure 1. Dual dribble tubes on planter



Figure 2. Dual band dribble immediately after planting



Conceal® system is a unique planter attachment that allows growers to place nitrogen in a high concentration dual or single band positioned 3" away from the seed trench (Figure 3.) at depths near 1.5". Conceal® system uses existing planter space, utilizing a backswept knife located with-in the center of the planter's gauge wheels. As nitrogen is applied, it is sealed within the soil profile by the gauge wheels, preventing potential volatilization losses that are typically problematic with surface type nitrogen applications.

Figure 3. Conceal® 3" away, 1.5" deep from the seed trench

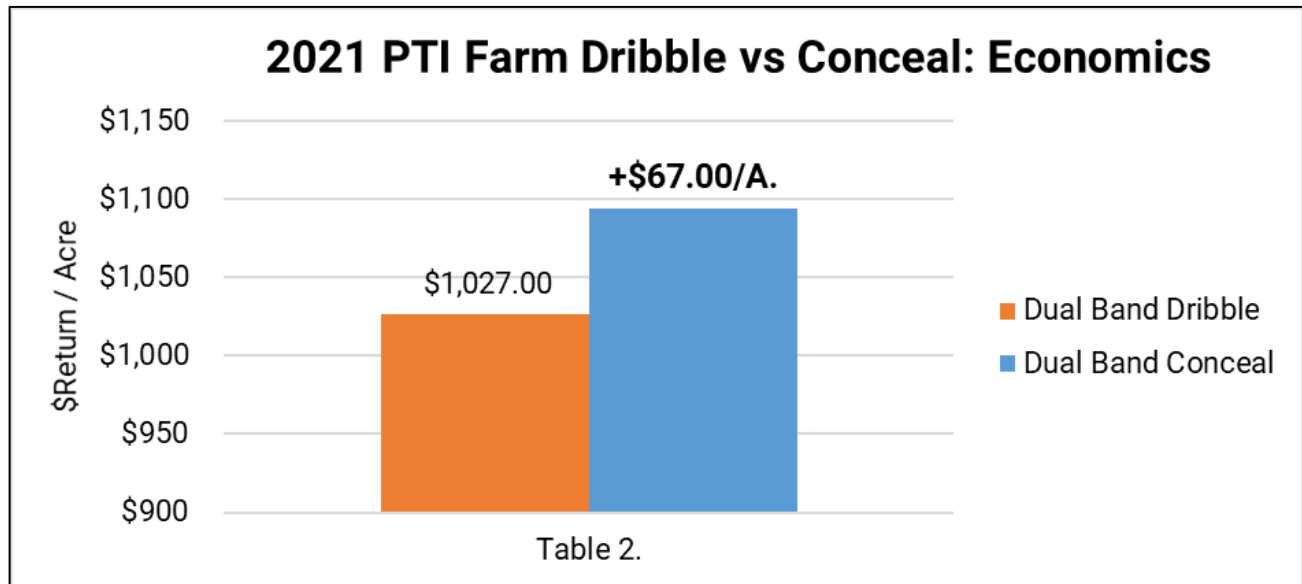
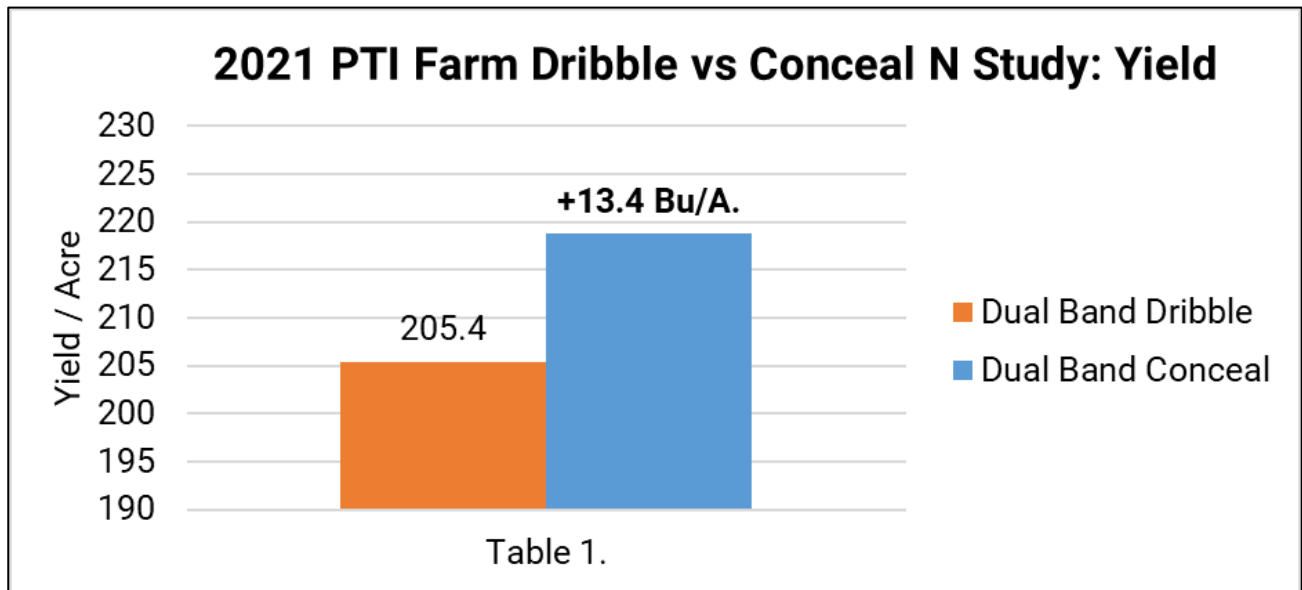


Figure 3. Conceal® 3" away, 1.5" deep from the seed trench



Dribble vs Conceal® Nitrogen Study Continued

Results: Dual band Conceal® placement of nitrogen proved yield gains of +13.4 Bu./A over dual dribble applications with economic gains of +\$67.00/A. At the PTI Farm, we measure the “Risk vs Reward” in any task at hand. In this case, it’s simply running the risk of surface applying nitrogen and allowing it to be exposed and vulnerable for volatilization loss. It’s a gamble waiting on rain for incorporation and safety from N loss.



Nitrogen Sealer Study

Objective: To evaluate the yield and economic impact of implementing nitrogen sealers when side-dressing corn with liquid nitrogen (N). Nitrogen sealers from Nitrogen Sealing Systems in Catlin, IL are a pair of coulters that attach to a side dress unit behind the knife or high-pressure injection nozzle (Figure 1-2). Sealers are designed to lift and redirect soil over top of the injection point of nitrogen, collapsing and sealing the trench, protecting nitrogen that could otherwise volatilize.

Volatilization is a form of N loss that occurs when nitrogen is applied on the soil surface without incorporation by tillage or rainfall events. In this event, applied nitrogen converts to ammonia, a gaseous form that can easily escape into the atmosphere. In a side-dress situation, this can occur when nitrogen is applied and not sealed or covered properly. If coulters slots open or become exposed to sunlight, air, wind, and increased temperatures after application, volatilization can occur.

Results: Tables 1-2. illustrate nitrogen sealers offering yield gains of +8.7 Bu/A., while capturing an additional \$43.50/A. 2020 data resulted in yield gains of +11.2 Bu/A. with increased revenue of +\$42.00/A.

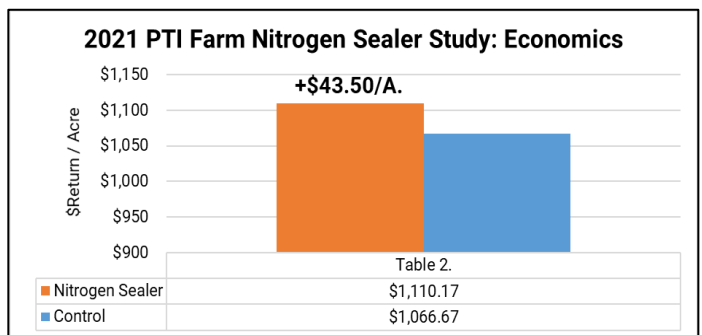
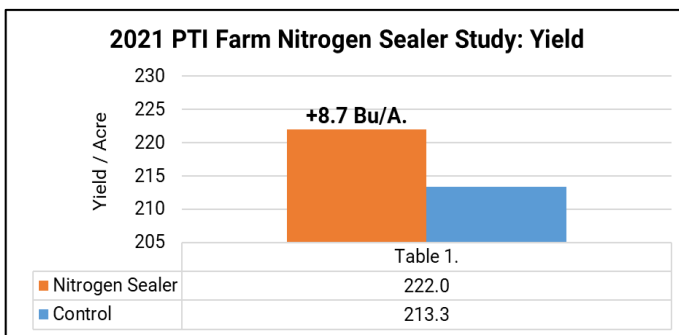
At a cost of \$285/row on a 15-knife side-dress applicator, break-even would occur at 100 acres.



Figure 1. Nitrogen Sealers

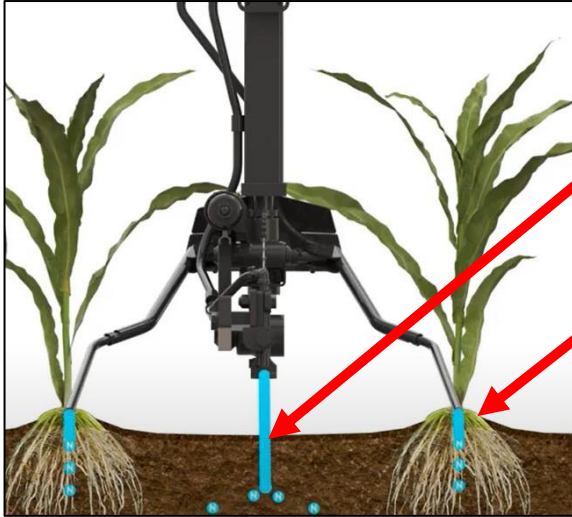


Figure 2. Sealed row with soil berm



Sidedress Nitrogen Placement Study:

Objective: To evaluate the yield and economic impact of implementing five different nitrogen side-dress application systems. These systems consist of incorporated center of row high pressure injection compared to banded near row surface applications with and without incorporation.



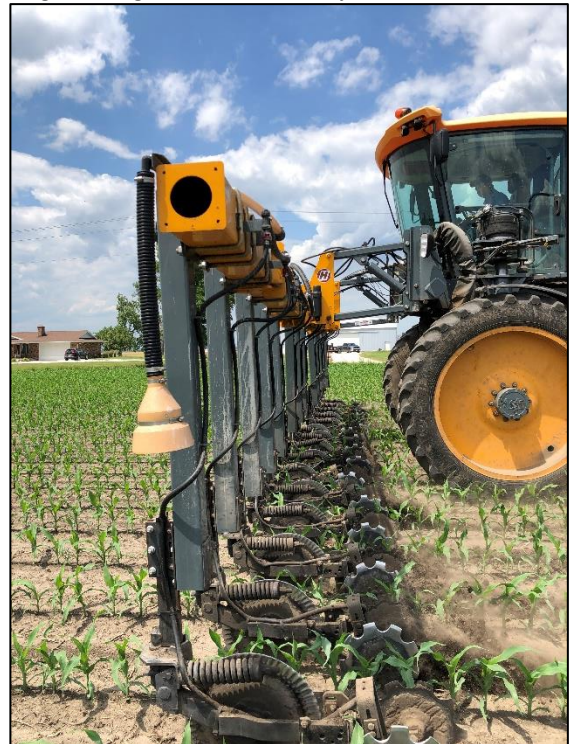
Center of Row Knife and Nozzle High Pressure Knife and Nozzle Injection

Banded Near Row Surface Injection with and without incorporation

Treatment #1: Hagie™ High Pressure Nozzle Injection with Nitrogen Sealing Systems (Figure 1.)

- Consistent high pressure nitrogen injection following a standard coultter
- Liquid placed in a high-pressure band in the center of the row
- This band of fertilizer is led by a 22" coultter and followed by two sealer discs to help close the slot to eliminate volatilization
- Can run at speeds of 9-10 mph

Figure 1. High Pressure Nozzle Injection with Sealers



Sidedress Nitrogen Placement Study:

Figure 2. High Pressure Knife Injection

Treatment #2: Unverferth® Knife Injection with Nitrogen Sealing Systems Sealers (Figure 4.)

- Standard single coulters system
- Nitrogen injection, following the coulters, consistently placed at the bottom of the knife
- 20" coulters with up to 1500lbs of down pressure



Figure 3. Dual Delivery N-Place Application

Treatment #3: Dual Delivery N-Place™ (Figure 2.)

- N-Place positions dual bands of fertilizer at the base of the plant, similar to a "Y-Drop" system and has the unique ability to cover bands of Nitrogen with soil to protect from volatilization
- N-Place can be installed on most Nitrogen sidedress bars and can work at speeds up to 12MPH, without pruning roots, and while delivering Nitrogen on target in a dual band at the base of the plant



Sidedress Nitrogen Placement Study:

Treatment #4: Surface Applied Dual Delivery System (Figure 4.)

- This system includes two trailing hoses, one mounted on each side of the coulter
- Similar to a “Y-Drop” system
- Runs liquid on top of the soil surface directly next to the corn plant.
- No incorporation ability

Figure 4. Surface Applied Dual Delivery Application



Sidedress Nitrogen Placement Study:

Treatment #5: Combo of Unverferth Knife Injection and Surface Applied Dual Delivery System

- This system is a combination of treatment #3 and #4.
- Applied liquid in a high-pressure injection knife lead by a 20" coulters plus soil surface applied bands of liquid fertilizer right next to the corn plant.

Figure 5. Surface Applied Dual Delivery Application

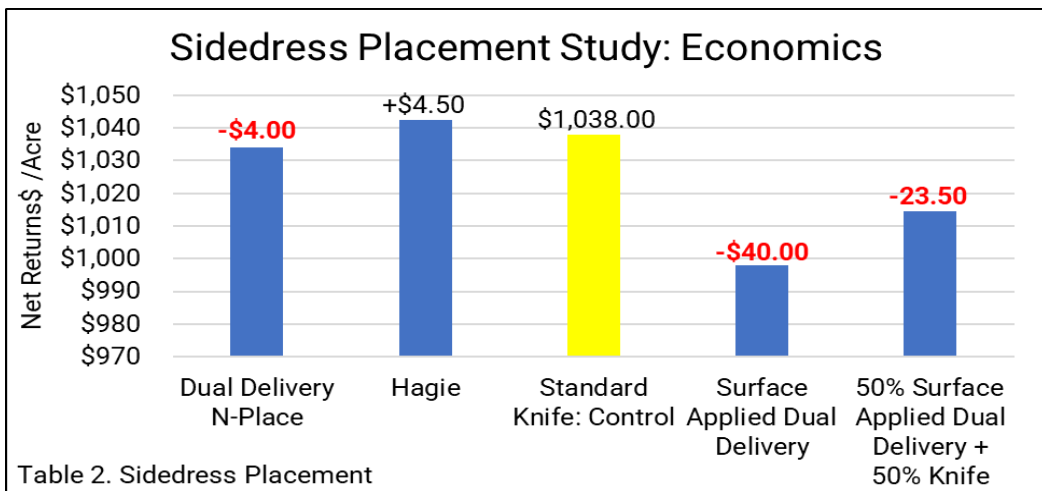
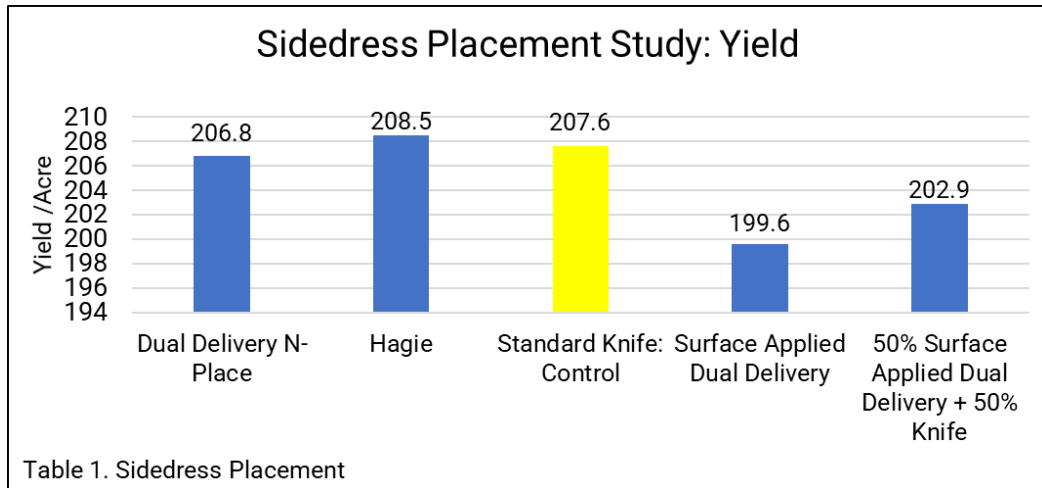


Sidedress Nitrogen Placement Study:

Results: For this study we use the high-pressure knife injection as the control, since it's more than likely the most common method implemented across the Midwest.

Tables 1-2. illustrate very little yield difference between all soil applied nitrogen application methods. In fact, all soil engaging methods of application resulted in yield differences of only 1.7 Bu.A.

Surface applications of nitrogen in general, resulted in the lowest yield and economic return in the study. These surface application methods offered yield losses of **-4.7 Bu/A.** to **-8.0 Bu/A.** with losses of **-\$23.50/A.** to **-\$40.00/A.** respectively compared to standard knife/sealed applications.



Conceal® K-Fuse® Potassium Study

Objective: To evaluate the yield and economics of NACHURS® K-Fuse powered by Bio-K® (Figure 1.), a 6-0-12-12S potassium/sulfur product designed to be blended with UAN fertilizer and applied on the planter or at side-dress. For this study we applied three, five, and eight gallons of K-Fuse at planting in a dual band Conceal® system application tank-mixed with 27 Gal/A. of UAN 32%. (Figure 2.).

Results: Table 1. illustrates K-Fuse applications reached agronomic optimum yield at the highest 8 Gal/A. Yield response ranged from +5.0 Bu/A. to +15.6 Bu/A.

As for economics, Table 2. reveals 5 Gal/A. of K-Fuse provided economic optimum rate with a positive return on investment of +\$47.37.

Multi-year data from 2019, 2020, and 2021 have proven yield gains of +12.53 Bu/A. along with positive return on investment of +\$29.38/A. at the 5 Gal/A. rate.

Figure 1. Nachurs K-Fuse® Potassium Additive

NUTRIENTS SUPPLIED (pounds per gallon):

Total Nitrogen (N)	0.65
Soluble Potash (K ₂ O)	1.30
Sulfur (S)	1.30

Derived from: Potassium Acetate, Ammonium Thiosulfate, and Urea.

PRODUCT PROPERTIES:

Analysis:	6-0-12-12S
Weight:	10.8 lbs. per gallon
Specific gravity:	1.30 kg/L
pH:	7.4-7.9
Appearance:	Clear, nearly colorless
Odor:	Ammonia odor

GENERAL PRODUCT INFORMATION:

NACHURS K-Fuse is designed to be blended with various other fertilizers to provide important nutrients needed to grow high-yielding crops. Primarily, NACHURS K-Fuses should be blended with UAN solutions for sidedress and/or fertigation application to provide two very critical elements - Potassium and Sulfur. It can also be mixed with APP and UAN for 2x2 and/or strip-till application to provide a more balanced nutrient program. NACHURS K-Fuse contains a proprietary additive which allows for more narrow mixing ratios with UAN solutions than other potassium products currently on the market. Always follow mixing recommendations so as to limit risk potential of forming low solubility potassium nitrate compounds. NACHURS K-Fuse should not come in close proximity to the seed under any circumstance (i.e. in-furrow placement).

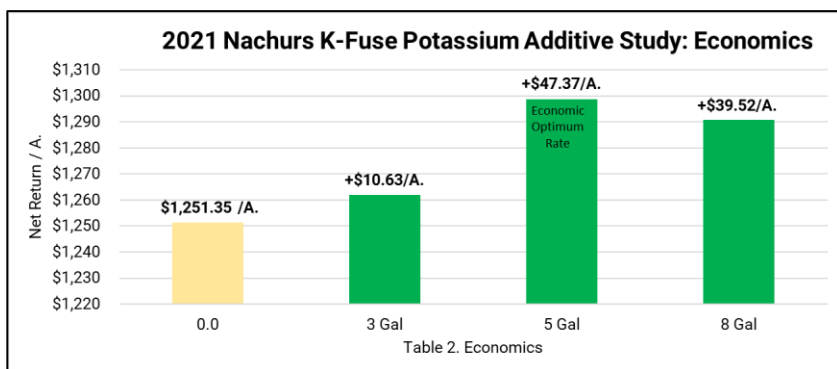
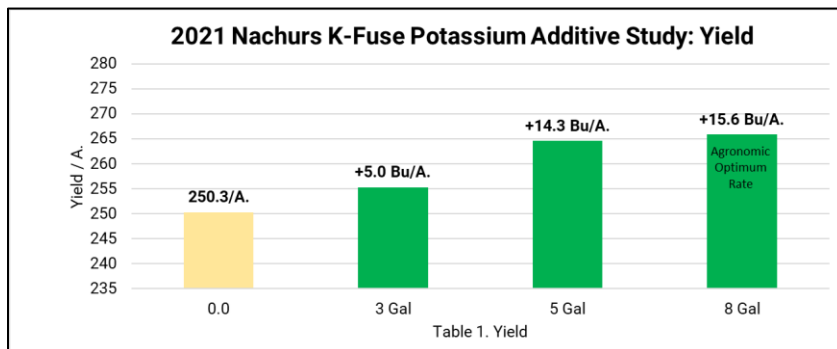
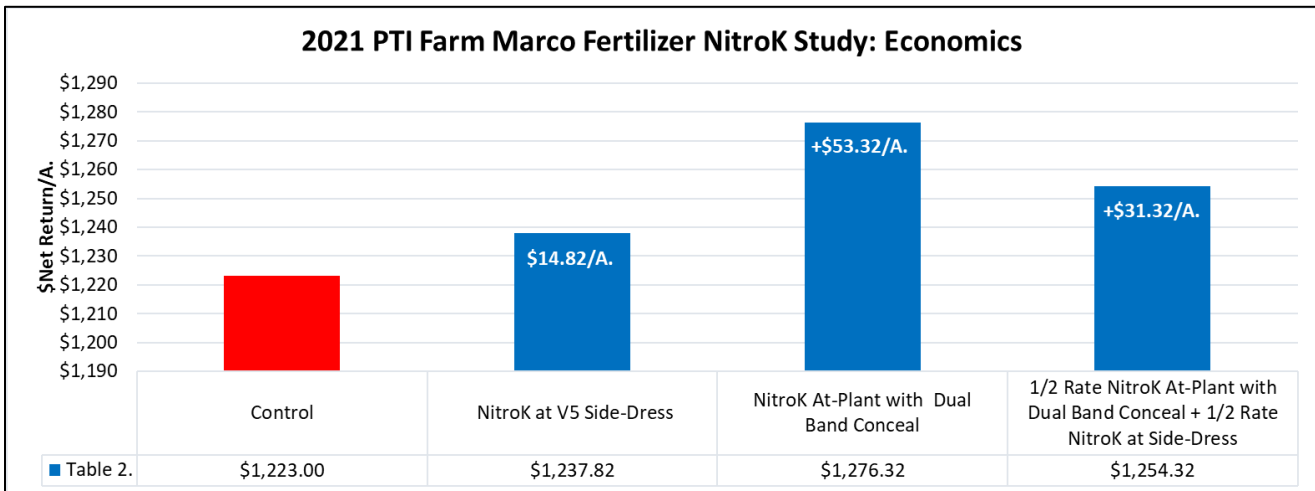
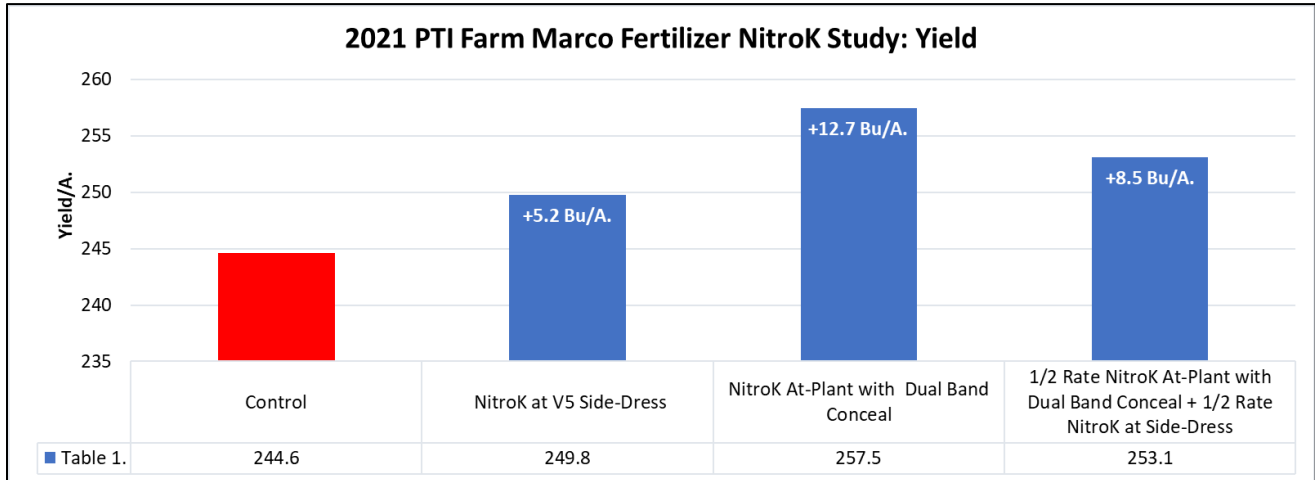


Figure 2. Conceal® Dual Placement 3” from Seed Furrow, 1.5” in Depth

Marco Nitro K Conceal® Study



Objective: To evaluate the yield and net return of Marco Fertilizer's Nitro K, a 22-0-4-4S liquid fertilizer as a nutritional aid in providing season long availability of nitrogen, potassium, and sulfur. In this study, Nitro K is applied at a 60# N rate as a 32% UAN tank-mix partner in a V5 side-dress, as well as an at-plant dual band Conceal® system application.



Results: All Nitro K applications proved profitable, however Table 1. illustrates Nitro K at-plant in a dual band Conceal® system proved highest yield advantages of +12.7 Bu/A. with positive economic returns of +\$53.32/A. (Table 2).

Nitrogen, Sulfur, Boron Conceal® Study

Objective: To evaluate the yield and economic impact of tank-mixing Sulfur and Boron with at-plant nitrogen applications applied via dual band Conceal® system (Figure 1). In this study 20 Gal/A. of UAN 32% nitrogen is used as a baseline control and compares adding 3 Gal/A. of ammonium thiosulfate 12-0-0-26 (ATS), as well as 1 qt. of a 10% Boron.

Sulfur (S) is an essential nutrient for corn growth and is a critical nutrient to make required proteins. One bushel of corn typically requires 0.1 to 0.12lbs/Bu. S uptake occurs over the entire growing season, with relatively constant uptake from the 14-leaf stage to maturity. Unlike nitrogen, only 40% to 50% of S is taken up by flowering (see Figure 2. chart below). S is also very mobile in most soils, like nitrate, because it has a double negative charge and is repelled by the negative charge of the soil, unlike nutrients like potassium, calcium, or magnesium.

Due to the Clean Air Act Amendment of 1990, major emission reductions of sulfur dioxide (SO₂) were put in place to the power sector. Figure 3. shows the difference in sulfur deposition over time from 2001 to 2015 as a result of this legislation. This reduction of free S in the atmosphere has created a situation where farmers may now need to apply S-fertilizer to crops for optimum yields.

Figure 1. Conceal® Dual Band Application

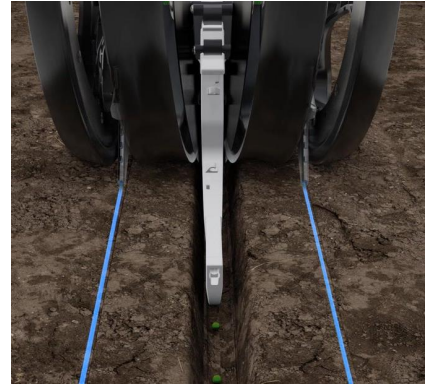
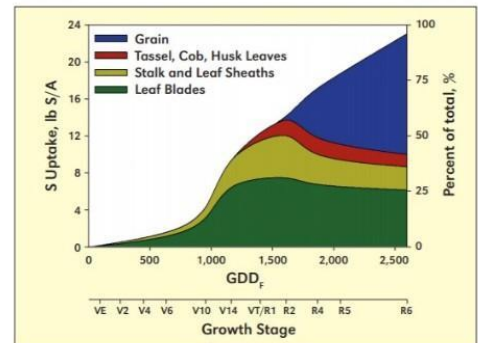
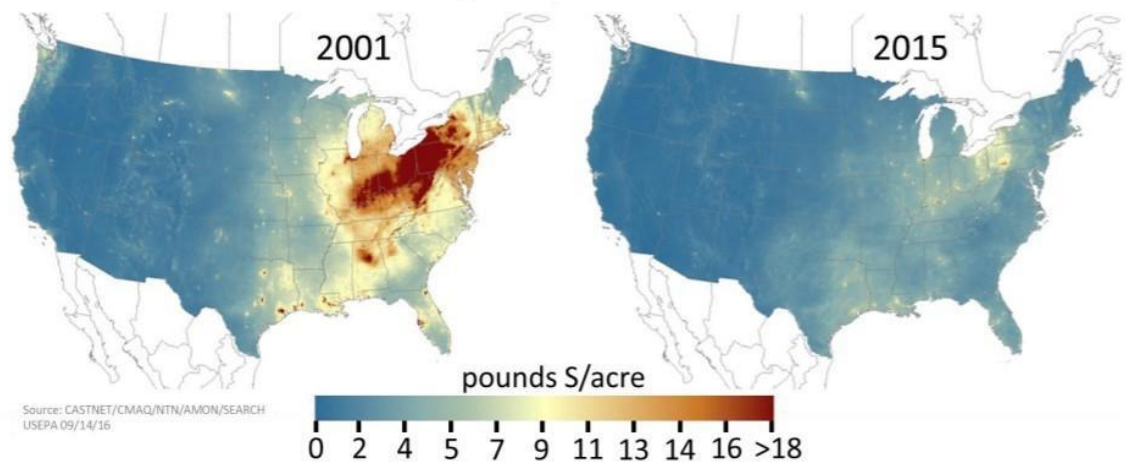


Figure 2. Sulfur Uptake Graph



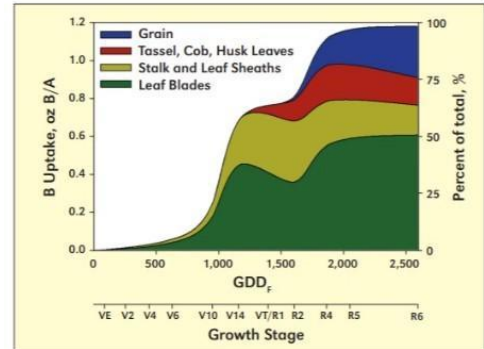
Total deposition of sulfur



Nitrogen, Sulfur, Boron Conceal® Study

Boron (B) is a micronutrient critical to the growth and health of all crops. It is a component of plant cell walls and reproductive structures. Boron, a water-soluble micronutrient, is especially prone to leaching. Since boron is a neutrally charged ion, it floats in ecosystems until it finds a substance to which it can bond to. During periods of heavy rain, boron is flushed out of the soil quickly. Boron serves two primary roles; one is supporting plant cell division, and the second is during the silking stage of development, in which boron helps transfer water and nutrients from the roots up through the plant. B is required in small amounts, in fact a 200 Bu/A. crop only uptakes 0.2lbs of B. Boron containing fertilizers typically should not be applied in close contact with seeds for any crop, since boron will injure germinating seeds.

Figure 4. Boron Uptake Graph



Results: Tables 1-2. illustrate that 3 Gal/A. of ATS provided yield gains of +4.5 Bu/A. with a positive return on investment of +\$17.16/A. 1qt. of Boron tank-mixed with the UAN and ATS, resulted in additional yield gains of +3.9 Bu/A. with net returns of +\$11.66/A.

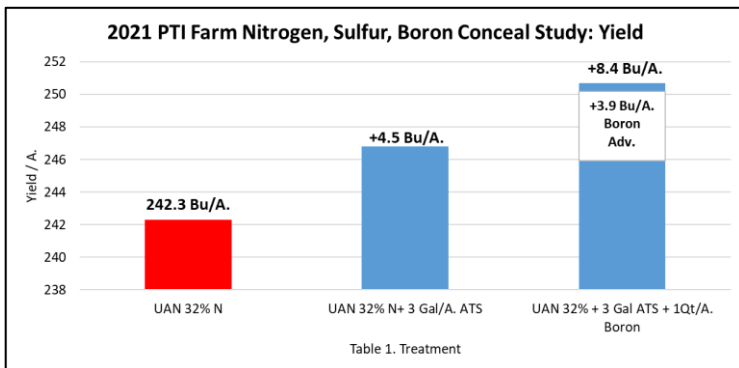
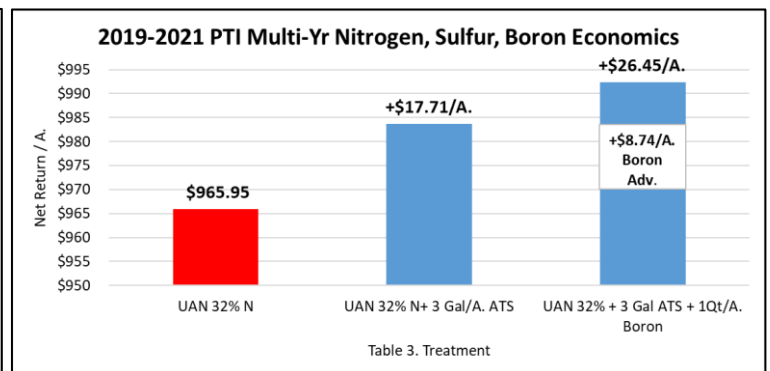
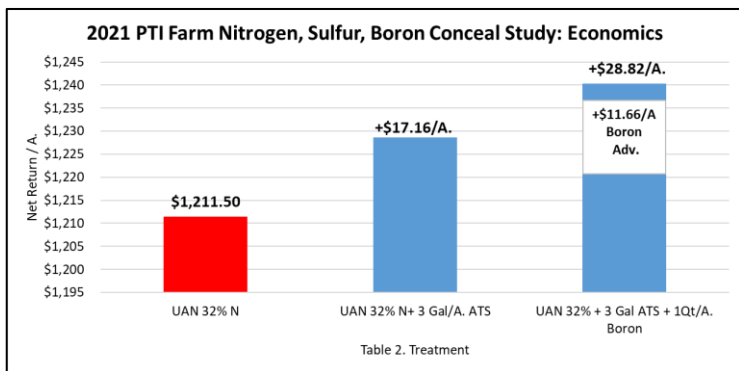


Table 3. reveals multi-year data over the time frame of 2019 to 2021. ATS applications over this time frame have averaged a positive net return on investment of +\$17.71/A. Boron has over the same time period contributed gains of +\$8.74/A.



Planting Date: April 27

Hybrid: DKC 65-95

Population: 36K

Row Width: 30"

Rotation: CAB

Corn Price: \$5.00

ATS: \$1.78/Gal.

10% Boron: \$10.02/Gal.

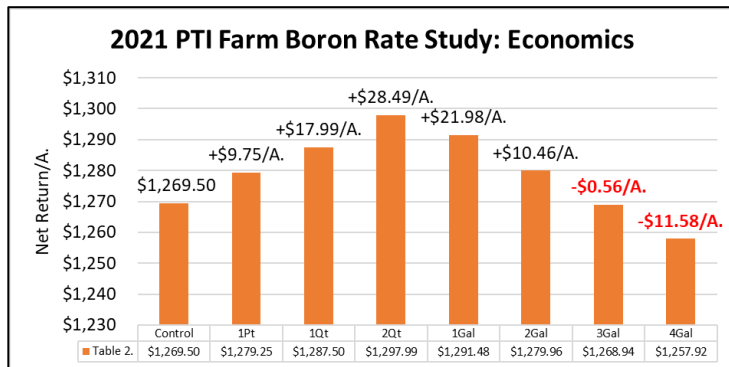
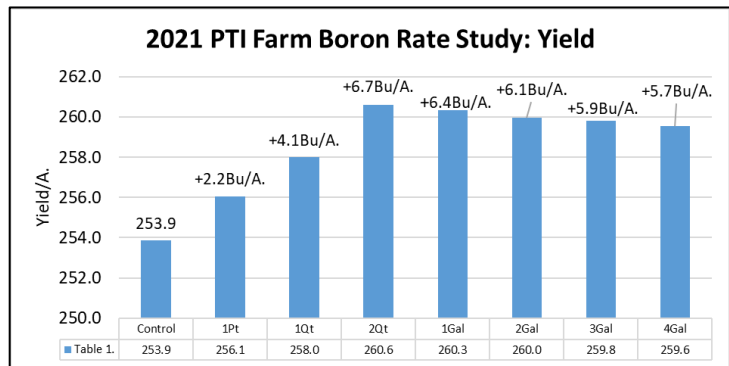
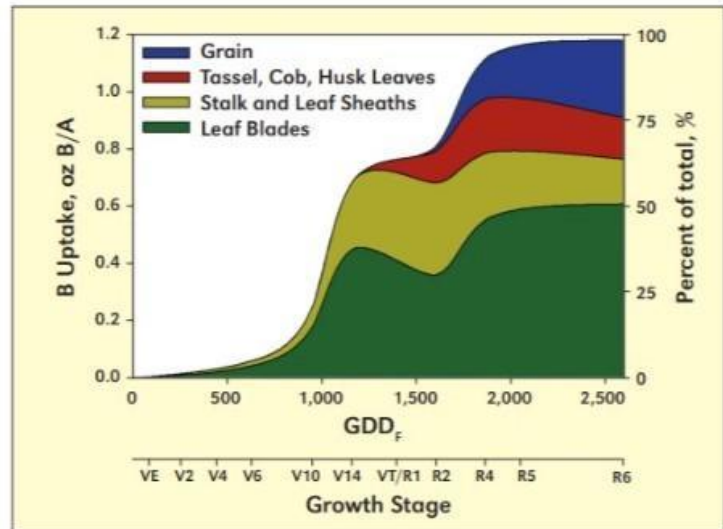
Boron Rate Study

Objective: To evaluate the yield and economic impact of tank-mixing multiple rates of Boron with at-plant nitrogen applications applied via dual band Conceal® system. Rates of 1 Pt, 1 Qt, 2 Qt, 1 Gal, 2 Gal, 3 Gal, and 4 Gal of a 10% Boron product was used in this study.

Boron (B) is a micronutrient critical to the growth and health of all crops. It is a component of plant cell walls and reproductive structures. Boron, a water-soluble micronutrient, is especially prone to leaching. Since boron is a neutrally charged ion, it floats in ecosystems until it finds a substance to which it can bond to. During periods of heavy rain, boron is flushed out of the soil quickly. Boron serves two primary roles; one is supporting plant cell division, and the second is during the silking stage of development, in which boron helps transfer water and nutrients from the roots up through the plant. B is required in small amounts, in fact a 200 Bu/A. crop only uptakes 0.2lbs of B. Boron containing fertilizers typically should not be applied in close contact with seeds for any crop, since boron will injure germinating seeds.

Results: Tables 1-2 illustrate that 2 Qt/A. of Boron provided both agronomic and economic optimum rate with yield gains of +6.7 Bu/A. and net returns of +\$28.49/A. over the control.

After 2 Qt/A. rates, no additional yield gains were realized.



Nitrogen to Sulfur Ratio Study

Objective: To evaluate the yield and economic impact of sulfur applications in corn with concentration on identifying the correct nitrogen to sulfur ratio.

Sulfur (S) is an essential nutrient for corn growth and is critical to make required proteins. One bushel of corn typically requires 0.1 to 0.12lbs/Bu. S uptake occurs over the entire growing season, with relatively constant uptake from the 14-leaf stage to maturity. Unlike nitrogen, only 40% to 50% of S is taken up by flowering (see Figure 1. chart to right).

S is also very mobile in most soils, like nitrate, because it has a double negative charge and is repelled by the negative charge of the soil, unlike nutrients like potassium, calcium, or magnesium.

Unlike nitrogen, sulfur is not readily remobilized from older to younger leaves. Therefore, sulfur deficiency is characterized by a yellowing of the younger or “new” leaves of the corn plant. When the corn plant is small, mild sulfur deficiency symptoms show up as interveinal chlorosis of the leaves emerging from the whorl (Figure 2).

At the PTI Farm, we have maintained a 7:1 nitrogen to sulfur ratio as a staple of our fertility management program. This study evaluates a range of rates including ratios of 34:1 to 3.5:1.

Figure 1. Sulfur Uptake Graph

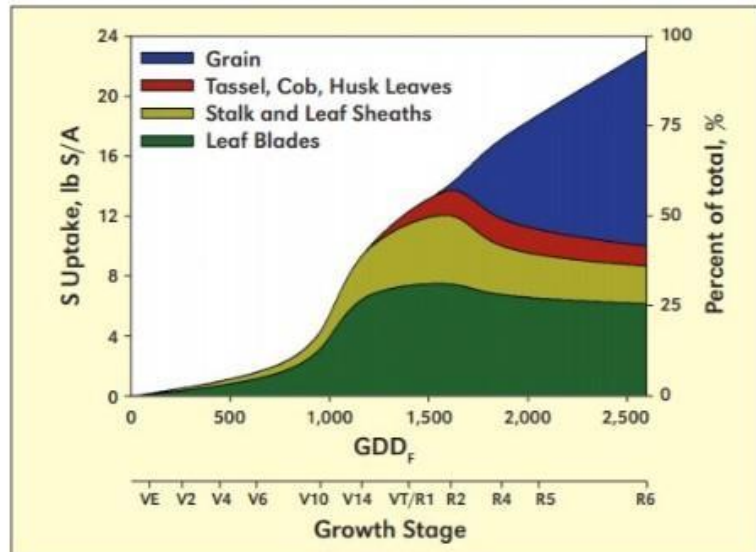


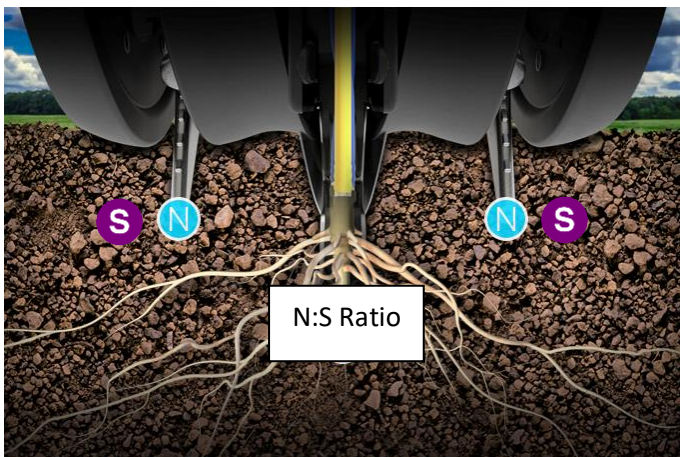
Figure 2. Sulfur Deficiency in Corn



Nitrogen to Sulfur Ratio Study Continued

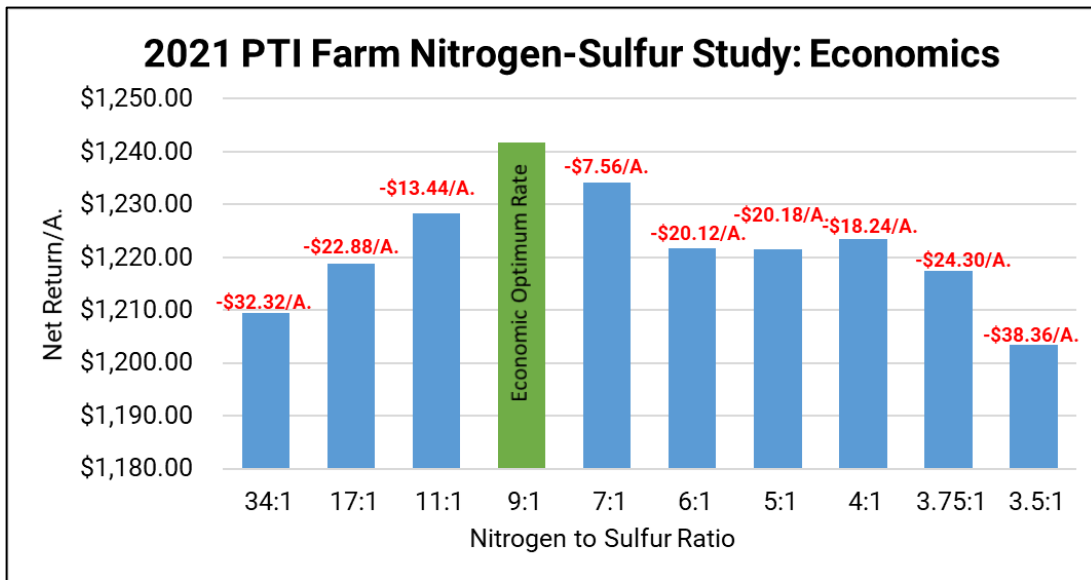
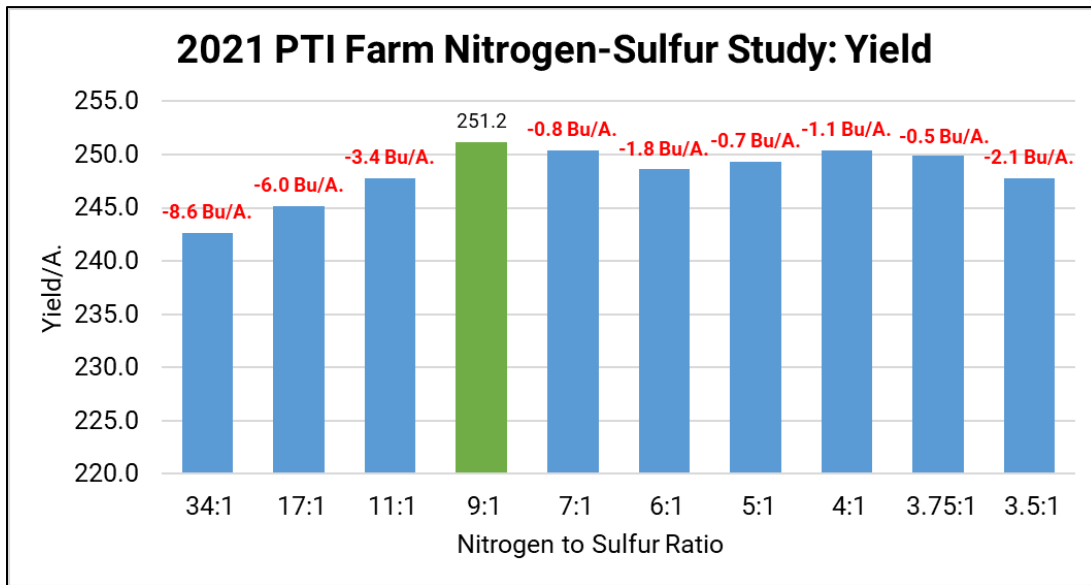
To identify agronomic and economic optimum N:S ratios, Ammonium Thio-Sulfate (ATS 12-0-0-26S) is applied as a Sulfur component with 32% UAN liquid nitrogen. 50% of the total nitrogen and sulfur is applied at-plant in a dual band Conceal® system and the other 50% in a traditional high pressure knife injection side-dress at the V4 growth stage.

<u>Ammonium Thiosulfate Rate</u>	<u>Nitrogen-Sulfur Ratio</u>
2 Gal	34:1
4 Gal	17:1
6 Gal	11:1
8 Gal	9:1
10 Gal	7:1
12 Gal	6:1
14 Gal	5:1
16 Gal	4:1
18 Gal	3.75:1
20 Gal	3.5:1



Nitrogen to Sulfur Ratio Study Continued

Results: Economic optimum ATS rates were realized at the 9:1 nitrogen to sulfur ratio. Insufficient rates of sulfur resulted in economic losses ranging from **-\$13.44** to **-\$32.32/A.** Over-application of sulfur tallied losses ranging from **-\$7.56/A.** to **-\$38.36/A.**



Conceal® Nitrogen Placement in Cover Crop Study

Objective: This trial is designed to evaluate the differences in yield and economic benefits of a dual band Conceal® system nitrogen application, compared to a surface applied nitrogen application in a ryegrass cover crop environment. (Figure 1.)

Figure 1. Fall Cover Crop Seeding

Conceal® is a unique planter attachment that allows growers to place nitrogen in a high concentration dual or single band positioned 3" away from the seed trench (Figure 2.) at depths near 1.5". Conceal® system uses existing planter space, utilizing a backswept knife located with-in the center of the planter's gauge wheels. As nitrogen is applied, it is sealed within the soil profile by the gauge wheels, preventing potential volatilization losses that are typically problematic with surface type nitrogen applications.



Figure 2. At-Plant Conceal Dual Band Nitrogen

For this study, 45#/A. of a cereal ryegrass was planted in the fall of 2020. After the ryegrass emerged, a fall strip-till was then completed to create an ideal seed-bed in 30" rows. In the spring, corn was planted into the strips, with the green cover crop.

To monitor nitrogen performance, a surface applied 32% UAN nitrogen spray was applied broadcast over the planted corn row. This pre-emergence application was only made on the strip-till bands. The green ryegrass cover crop was not sprayed with liquid nitrogen to eliminate burning or defoliation that could decrease efficacy of the later V2 termination.

As a direct comparison, dual band Conceal® treatments were made at planting.

All treatments totaled 225# nitrogen, with 100# applied as either a surface applied or Conceal® pre-emerge N. In addition, all treatments received 125# of nitrogen applied as a V4 side-dress.

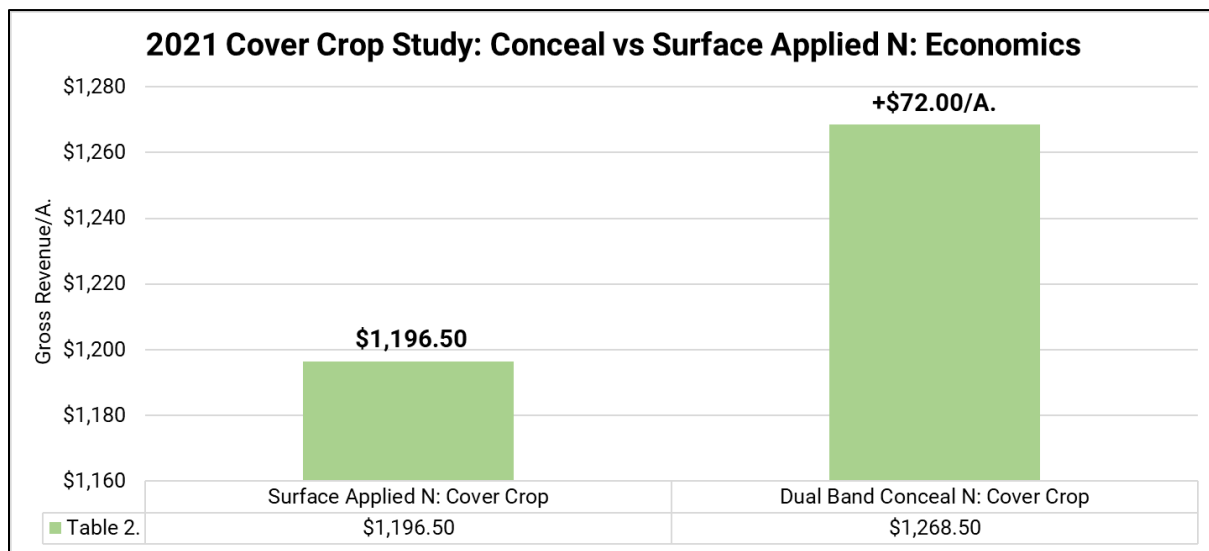
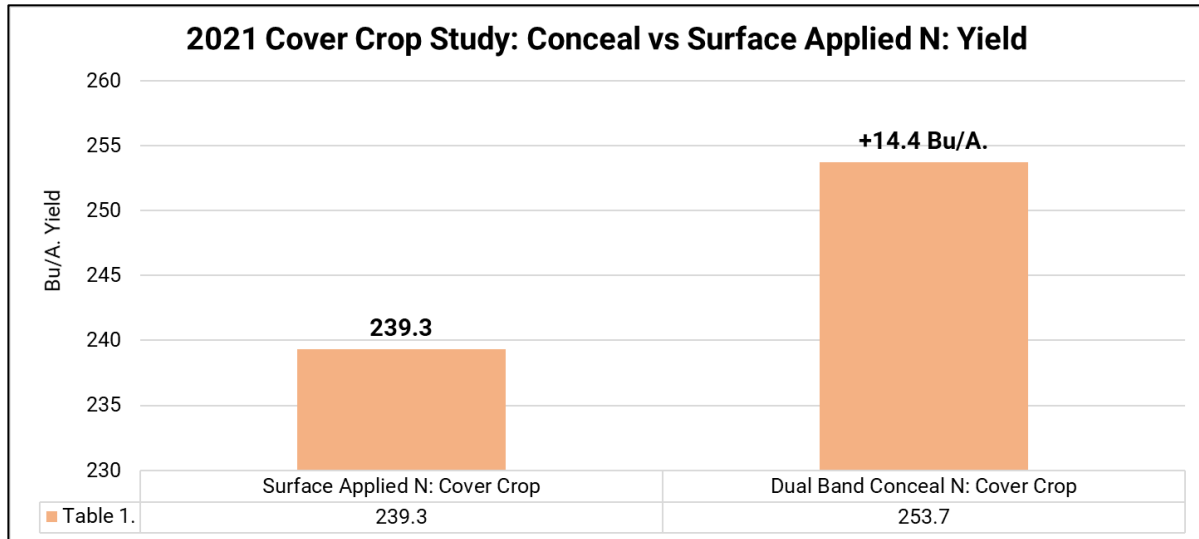
Termination of the ryegrass was made at the V2 growth stage.



Figure 3. Side-Dress Nitrogen



Conceal® Nitrogen Placement in Cover Crop Study



Results: Tables 1-2. illustrate at-plant Conceal® dual band applications of nitrogen resulted in additional yield gains of +14.4 Bu/A. compared to surface applied broadcast nitrogen. These gains resulted in revenue gains of +\$72.00/A.

Feeding a corn crop in a cover crop system can be challenging, especially regarding nitrogen. However, dual band applications of nitrogen with Conceal® proved effective in providing high concentrated bands of nitrogen to adequately supply nitrogen to corn in this cover crop study.

Corn 2021 Summary of Conceal® Applications

Study	Classification	Yield (Bu/A.)	\$ROI	Page #
Conceal Rate/Placement: Triple Split over 100% WNF	Nitrogen	23.2	\$ 116.00	108-111
Conceal Rate/Placement: 75% Conceal Dual Band+50% Side-Dress	Nitrogen	19.4	\$ 76.75	108-111
Nachurs Start2 Finish Corn Fertility	Potassium	16.9	\$ 73.76	77
Conceal Nitrogen Placement Cover Crop - Dual Band over Surface Applied N	Nitrogen Placement	14.4	\$ 72.00	114-115
Nachurs High Yield Conceal	Starter Fertilizer +Nitrogen	16.8	\$ 68.53	55-56
Dribble vs Conceal	Nitrogen Placement	13.4	\$ 67.00	114-115
Conceal Rate/Placement: 25% Conceal+25%WNF+50% Side-Dress	Nitrogen	12.5	\$ 62.50	108-111
Andersons 5oz RGS + 3Gal ATS	Biological + N + S	6.4	\$ 54.39	71-72
Conceal Rate/Placement: 50% WNF+50% Side-Dress over 100% WNF	Nitrogen	10.7	\$ 53.50	108-111
Marco Corn Nitro K 22-0-4-4S Dual Band Conceal	Nutrogen + S	12.7	\$ 53.32	123
Andersons Corn Combo Treatment	Biological + N + S	13	\$ 51.64	71-72
Nachurs Corn Conceal K-Fuse 5Gal	Potassium	14.3	\$ 47.37	122
Conceal Rate/Placement: 50% Conceal Dual Band+50% Side-Dress	Nitrogen	9.1	\$ 45.50	108-111
Nachurs Corn Conceal K-Fuse 8Gal	Potassium	15.6	\$ 39.52	122
100% Dual Band over WNF	Nitrogen	6.9	\$ 34.50	108-111
Marco Corn Nitro K 22-0-4-4S 1/2 Rate Conceal 1/2 Rate Side-Dress	Nitrogen + S	8.5	\$ 31.32	123
AgroLiquid Starter Fertility Program Corn	Micronutrients	11.2	\$ 31.30	73
Nitrogen , Sulfur, Boron Conceal 32%N + 3Gal/A. ATS + 1Qt Boron	Nitrogen + S	8.4	\$ 28.82	126
Boron Conceal Study 2Qt	Boron	6.7	\$ 28.49	126
9:1 Ratio Nitrogen to Sulfur	Nitrogen + S	5.56	\$ 27.80	127-129
Conceal Rate/Placement: 50% Conceal Single Band+50% Side-Dress	Nitrogen	4.8	\$ 24.00	108-111
April 6th Corn Plant Date w/Starter	Nitrogen	14.1	\$ 21.87	8-9
Conceal Dual Band over Single Band	Nitrogen	4	\$ 20.00	107
Nitrogen , Sulfur, Boron Conceal 32%N + 3Gal/A. ATS	Nitrogen + S	4.5	\$ 17.16	124-125
100% Single Band over WNF	Nitrogen	2.9	\$ 14.50	108-111
Xyway LFR Conceal Dual Band	Fungicide	6.5	\$ 14.50	91-94
BOOST 4-0-3-2S Nitrogen Inclusion Study 10% N Reduction + 5Gal Boost	Nitrogen + Carbon Based Sugar	5.8	\$ 12.33	112-113
Nachurs Corn Conceal K-Fuse 3Gal	Potassium	5	\$ 10.63	122
May 22nd Corn Plant Date w/Starter	Starter Fertilizer + K + N	9.3	\$ (2.00)	8-9
Boron Conceal Study 4 Gal	Boron	5.7	\$ (11.58)	126
Conceal Rate/Placement: 100% Conceal Dual Band	Nitrogen	-3.8	\$ (19.00)	108-111
10gal 10-34-0 FJ 3-Way over Conceal Dual Band	Phosphorus	6.4	\$ (23.00)	84
Conceal Rate/Placement: 100% Conceal Single Band	Nitrogen	-7.8	\$ (39.00)	108-111
Conceal Rate/Placement: 25% Conceal Dual Band+50% Side-Dress	Nitrogen	-14.1	\$ (50.25)	108-111
Average		8.5	\$ 31.01	



Corn Leaf Orientation Study

Objective: To study corn leaf orientation within the row and understand the relationship of yield impact of corn leaves being positioned parallel or perpendicular to the row (Figures 1-2). Correct leaf orientation offers benefits of increased light interception, less sunlight to encourage weed suppression, cooler in-canopy temperatures, and moisture preservation.

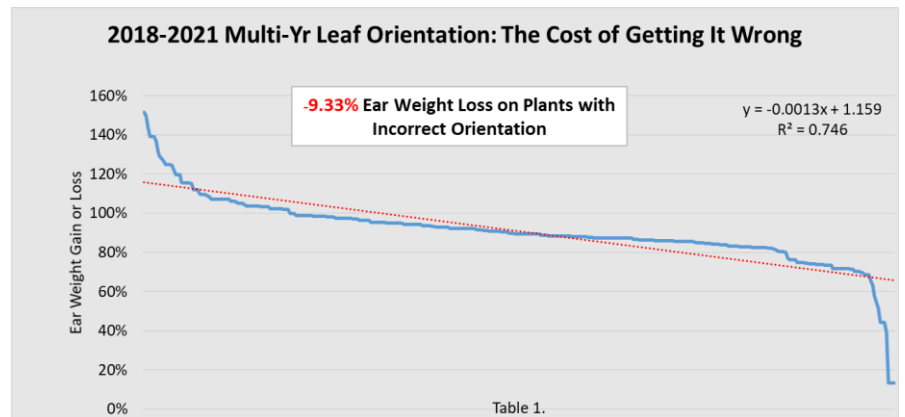


Figure 1. Correct Leaf Orientation



Figure 2. Incorrect Leaf Orientation

Results: Table 1. illustrates the multi-year results of yield checks at the PTI Farm from 2018 to 2021. Individual ear weight loss associated with incorrect leaf orientation resulted in **-9.33%** yield loss. Table 2. depicts average yield losses of **-18.7** to **-23.3 Bu/A.** for each plant with wrong leaf orientation. However, occurrence factors of these incorrect oriented plants generally range from only 20% to 30% of all plant population. Therefore, actual yield



losses from incorrect orientation range from **-3.7** to **-7.0 Bu/A.** depending on overall actual corn yield. Work is being done to establish solutions to help eliminate incorrect leaf orientation. Some of this work identifies seed placement in the seed furrow to manipulate direction of leaf placement. Early studies indicate that incorrect leaf orientation cannot be totally prevented, but trial data does suggest that placing seed in certain positions in the furrow can improve results by +10%. In general, seed tip directional placement has been seen to improve emergence timing, while embryo directional placement potentially may impact leaf orientation.

2018-2021	Table 2.	Occurrence Factor Percentage		
Overall Corn Yield	Yield Loss	20% Wrong	25% Wrong	30% Wrong
200	-18.7 Bu/A.	-3.7 Bu/A.	-4.7 Bu/A.	-5.6 Bu/A.
225	-21.0 Bu/A.	-4.2 Bu/A.	-5.2 Bu/A.	-6.3 Bu/A.
250	-23.3 Bu/A.	-4.7 Bu/A.	-5.8 Bu/A.	-7.0 Bu/A.

Corn Strip Planting Study

Objective: This study evaluates the yield and economic advantages of planting corn and soybeans in alternate 40' strips (Figure 1.). In the past this helped to reduce erosion. The PTI team evaluated this system in 2020 to harvest more sunlight on outside rows with the intention of trying to stimulate higher corn yield. It is quite common to have higher corn yield on the outside field edges (Figure 2.), due to corn being able to harvest more sunlight. However, most often after the first few rows this yield advantage decreases due to more shading of corn biomass. This study is intended to measure any potential yield increases and the associated economics from this system.

In order to understand the agronomics of this strip cropping system, we split our trial design into four segments:

- 40' Corn Blocks (16 rows) planted in North/South rows
- 40' Corn Blocks (16 rows) planted in East/West rows
- 20' Corn Blocks (8 rows) planted in North/South rows
- 20' Corn Blocks (8 rows) planted in East/West rows

Figure 1. 40' Alternate Strips of Corn and



Figure 2. Outside Edge of Field



Corn Strip Planting Study Continued

Figure 3. 40' (16row) Alternate Strip Planting of

Figure 3 illustrates the corn strips in a 40' or 16 row 30" block formation. These corn blocks were planted alternatively with 30" soybeans in both a North to South and East to West planting row to allow the ability to study the differences in sunlight shading. In corn, we also implemented the use of "shorter" stature corn being planted on the outside 4 rows of each 40' or 16 row blocks in an attempt to minimize shading of the soybeans from the corn.



Figure 4. 20' (8row) Alternate Strips of Corn Soybeans

Figure 4 illustrates corn strip planting in a 20' or 8 row 30" block formation. This corn was also planted alternatively with 30" soybeans in both a North to South, as well as an East to West planted row to allow the ability to study the differences in sunlight shading and overall yield differences between wide and narrower corn blocks. Both "shorter" stature corn and a tall hybrid were implemented in the 20' blocks, but only independently and not within the same block.

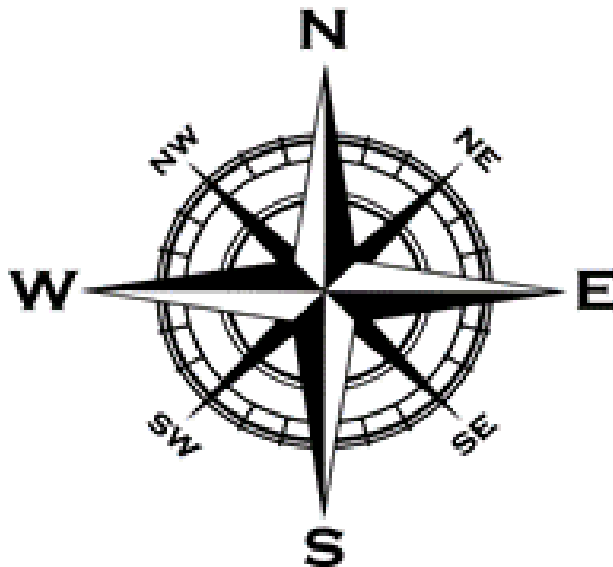


Corn Strip Planting Study Continued

In order to understand the agronomics of the 40' or 16 row blocks, we split our 16-row planter into seven individual segments to evaluate yield performance:



These seven individual segments were then planted in both north to south and east to west directional planting formations to evaluate the yield and economics on planter row direction.



Corn Strip Planting Study Continued

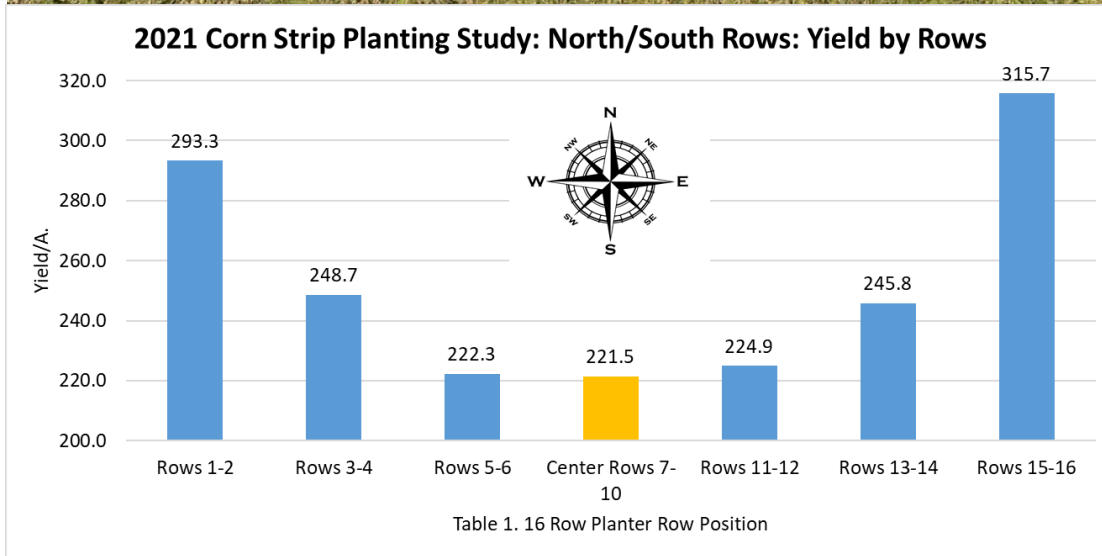


Table 1. illustrates the yield response of each planter row segment in the 40' alternate strips planted in a North/South formation. Compared to the center four planter rows, the outside two rows of the planter (rows 1-2 and 15-16) offered incredible average yield advantages of +71.8 to +94.2 Bu/A. Status quo full field planting would equate to 221.5 Bu/A. corn yield (center 4 rows), while this crop stripping experiment increased corn yield to 293 Bu/A. to 315.7 Bu/A. on the outside "solar corridor" two rows.

The outside two rows (1-2 and 15-16) increased revenue by +\$359/A. to +\$471/A. Rows 3-4 and 13-14 increased revenue by +\$121.50 to +\$136/A. and finally the inside rows 5-6 and 11-12 offered increases of only +\$4.00/A. to \$17.00/A.

Overall, North/South row strips planted in 40' (16 row) blocks offered **average** yield gains of +37 Bu/A. resulting in additional gains of +\$158.36/A.

Corn Strip Planting Study Continued

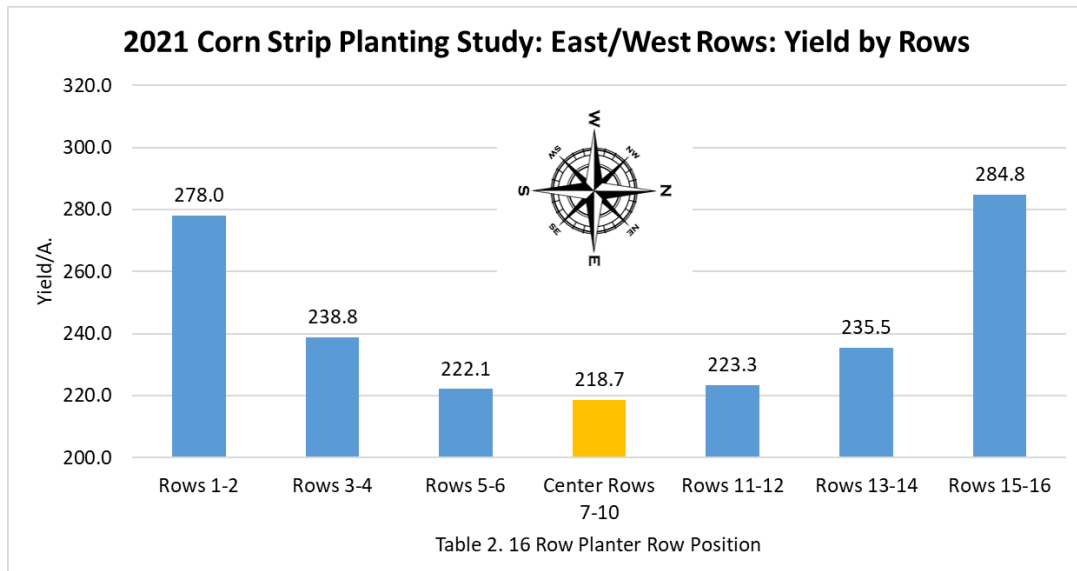


Table 2. illustrates the yield response of each planter row segment in the 40' alternate strips planted in an east/west formation. Compared to the center four planter rows, the outside two rows of the planter (rows 1-2 and 15-16) again offered incredible average yield advantages of +59.3 to +66.1 Bu/A. Status quo full field planting would equate to 218.7 Bu/A. corn yield (center 4 rows), while this crop stripping experiment increased corn yield to 278 Bu/A. and 284.8 Bu/A. on the outside "solar corridor" two rows.

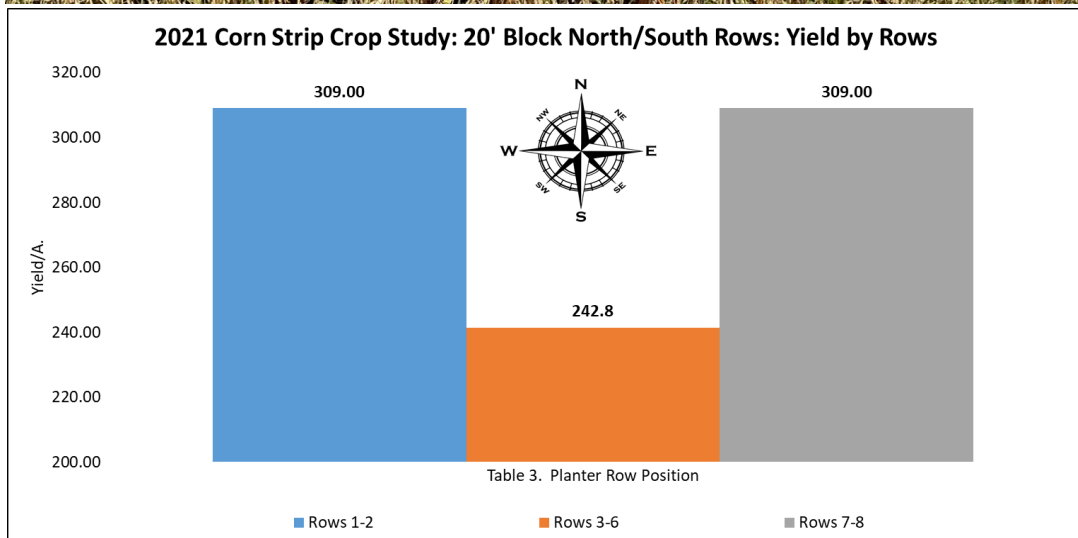
The outside two rows (Rows 1-2 and 15-16) increased revenue from +\$296.50/A. to +\$330.50/A. Rows 3-4 and 13-14 increased revenue by +\$84.00/A. to +\$100.50/A. and finally the inside rows 5-6 and 11-12 offered increases of +\$17.00/A. to \$23.00/A.

Overall, east/west row strips planted in 40' (16 row) blocks offered **average** yield gains of +28.4 Bu/A. resulting in additional gains of +\$121.64/A.

Corn Strip Planting Study Continued

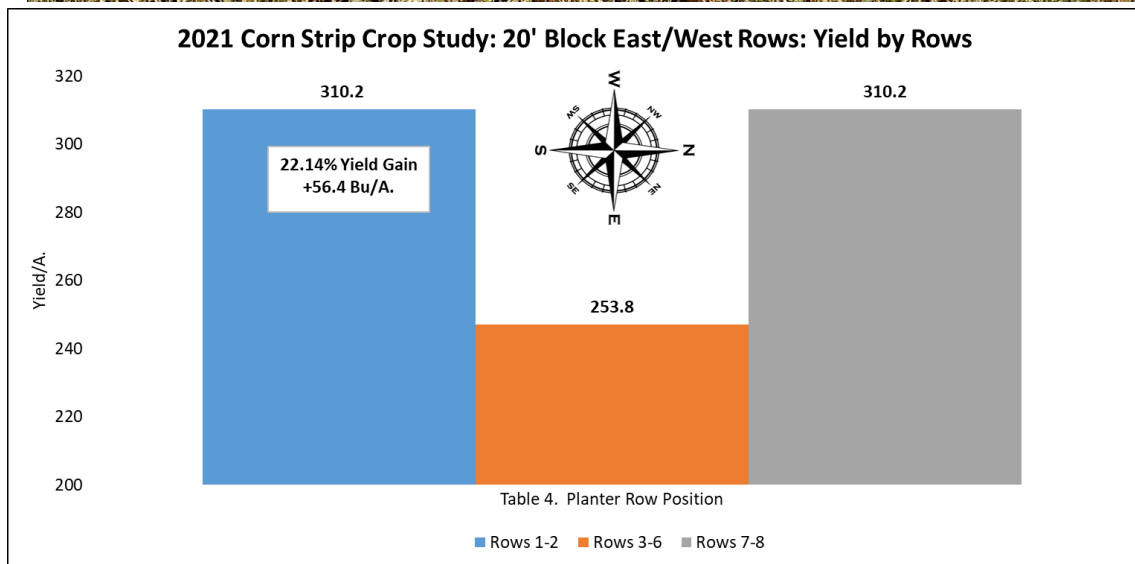
In an effort to understand corn yield in strips by block size, 20' (8 row) blocks were planted with a four-row planter. This smaller configuration allows for more "solar corridor" outside rows and reduces the 40' blocks to half the size.

Table 3. illustrates the yield response of outside versus inside rows in the 20' alternate strips planted in a north/south planting formation. Compared to the center four planter rows, the outside two rows of the planter (rows 1-2) offered average yield advantages of +66.2 Bu/A. and +\$331.00/A. in additional revenue. Center section rows averaged 242.8 Bu/A. corn yield, while 309.0 Bu/A. on the outside "solar corridor" rows.



Corn Strip Planting Study Continued

Table 4. illustrates the yield response of outside versus inside rows in the 20' alternate strips planted in an east/west planting formation. Compared to the center four planter rows, the outside two rows of the planter (rows 1-2) offered average yield advantages of +56.4 Bu/A. and +\$282.00/A. in additional revenue. Center section rows averaged 253.8 Bu/A. corn yield, while 310.2 Bu/A. on the outside "solar corridor" rows.



Corn Strip Planting Study Continued

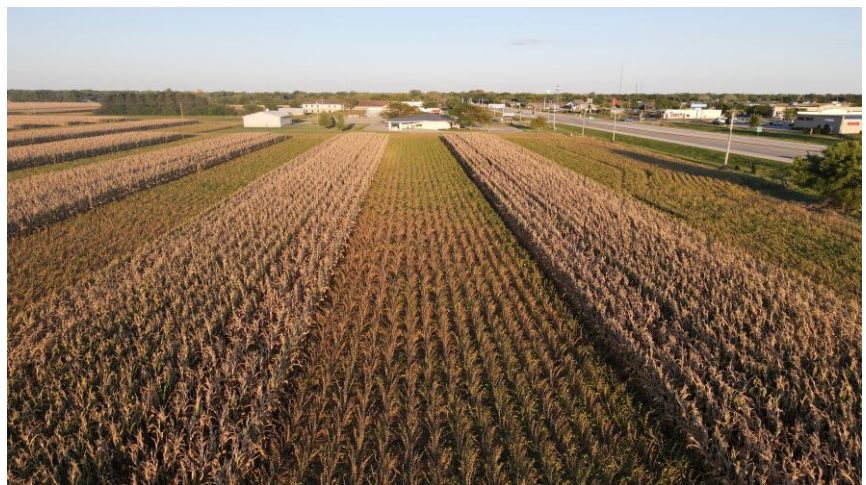
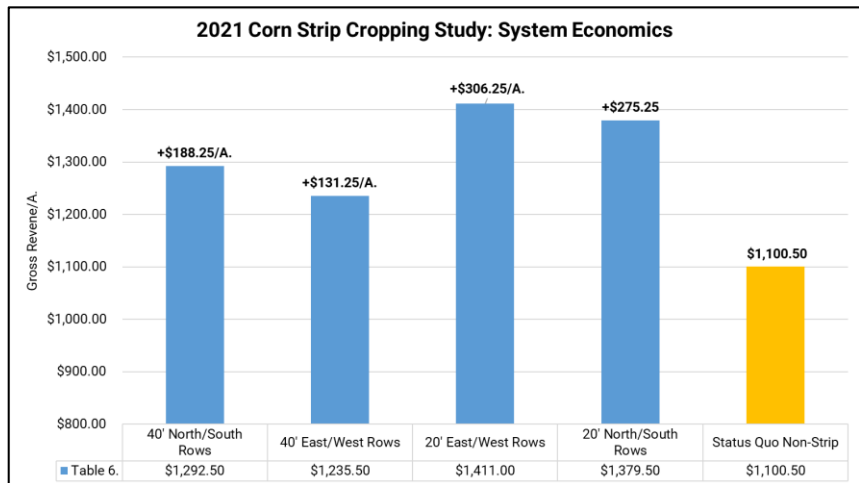
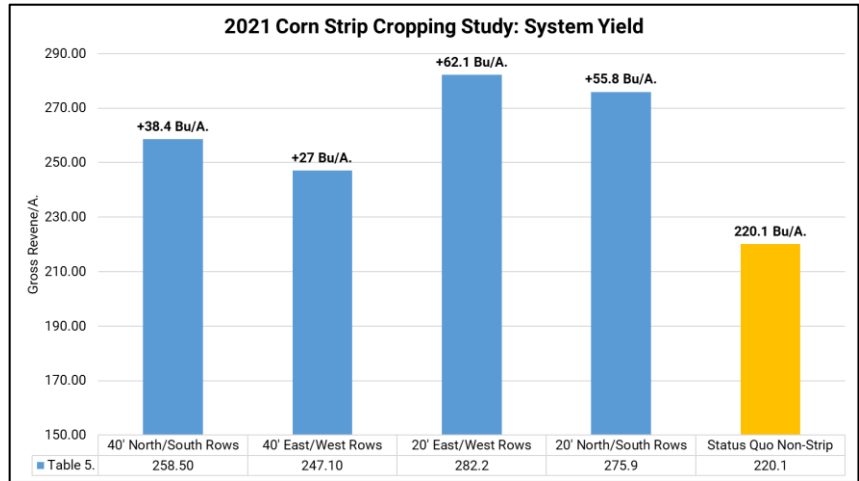
2021 corn strip cropping at the PTI Farm was very successful and proved to be one of the highest overall revenue contributors on the farm. Table 5. illustrates the yield gains of strip cropping compared to a status quo traditional non-strip row-cropping practice.

40' (16row) strips resulted in overall yield gains of +27.0 to 38.4 Bu/A., with north/south rows proving +11.4 Bu/A. over east/west rows.

20' (8row) strips resulted in overall yield gains of +55.8 to 62.1 Bu/A., with east/west rows proving +6.3 Bu/A. over north/south rows.

As for economics, Table 6. reveals the overall differences in gross revenue. 40' strips resulted in gains of +\$131.25 to +\$188.25/A., while 20' strips tipped the scale at a remarkable +\$275.25 to +\$306.25/A.

At the PTI Farm, we always talk about challenging the status quo and trying to farm smarter each and every season. This strip cropping system, even though challenging to implement with herbicide and nutrient applications and general equipment sizing, proved to create some unbelievable and significant gains. We look forward to continuing testing this system in the future.



Stoller®USA Corn V2 Growth Stage Foliar Application Study

Objective: To evaluate the yield and net return of StollerUSA's Fortified Stimulate® Yield Enhancer Plus, Harvest More™ Urea Mate and Harvest Plus applied foliar at the V2 growth stage.

Fortified Stimulate® Yield Enhancer Plus is a plant growth regulator and EPA registered plant bio stimulant that has four growth hormone ingredients that promotes plant growth. This product contains four key plant hormones including Cytokinin, Gibberellic acid, Indole-3-butyric acid, and Indole-3-acetic acid.

HARVEST MORE™ UREA MATE 5-10-27 is a complete fertilizer with both macro and micronutrients in a readily available water-soluble acidic formulation.

Harvest Plus is 8-0-0 premium liquid fertilizer that also contains 3% Sulfur, .25% Boron, 3% Manganese, and 3% Zinc.



ACTIVE INGREDIENTS:

Cytokinin (as kinetin)	0.009%
Gibberellic acid	0.005%
Indole-3-butyric acid	0.005%
Indole-3-acetic acid	0.005%
OTHER INGREDIENTS:	99.976%
Total	100.000%

CONTAINS NON-PLANT FOOD INGREDIENTS:

0.009% Cytokinin
0.005% Gibberellic Acid
0.005% Indole-3-butyric Acid
0.005% Indole-3-acetic Acid

Information regarding the contents and levels of metals in this product is available on the internet at <http://www.aapfco.org/metals.html>

HARVEST MORE™ UREA MATE 5-10-27

GUARANTEED ANALYSIS

Total Nitrogen (N)	5%
5% Urea Nitrogen	
Available Phosphate (P ₂ O ₅)	10%
Soluble Potash (K ₂ O)	27%
Calcium (Ca)	4%
4% Chelated Calcium	
Magnesium (Mg)	1.5%
1.5% Chelated Magnesium	
Boron (B)	0.15%
Cobalt (Co)	0.008%
0.008% Chelated Cobalt	
Copper (Cu)	0.3%
0.3% Chelated Copper	
Manganese (Mn)	0.5%
0.5% Chelated Manganese	
Molybdenum (Mo)	0.008%
Zinc (Zn)	0.5%
0.5% Chelated Zinc	

Plant nutrients derived from urea phosphate, potassium chloride, urea, boric acid, sodium molybdate, calcium EDTA, magnesium EDTA, cobalt EDTA, copper EDTA, manganese EDTA and zinc EDTA.

Harvest Plus

8-0-0

Enhanced Micro Blend

GUARANTEED ANALYSIS

Total Nitrogen (N)	8%
8% Ammoniacal Nitrogen (N)	
Sulfur (S)	3%
3% Combined Sulfur (S)	
Boron (B)	0.25%
Manganese (Mn)	3%
3% Chelated Manganese (Mn)	
Zinc (Zn)	3%
3% Chelated Zinc (Zn)	

Derived from aqueous ammonia, boric acid, manganese sulfate and zinc sulfate chelated with citric acid



Stoller

Stoller®USA Corn V2 Growth Stage Foliar Application Study

Results: Table 1. illustrates individual V2 applications of Fortified Stimulate resulted in average yield gains of +3.8 Bu/A. When Urea Mate was tank-mixed along with Fortified Stimulate, yield was improved by +0.6 Bu/A. and Harvest Plus tank-mixes resulted in additional +0.7 Bu/A. yield gains.

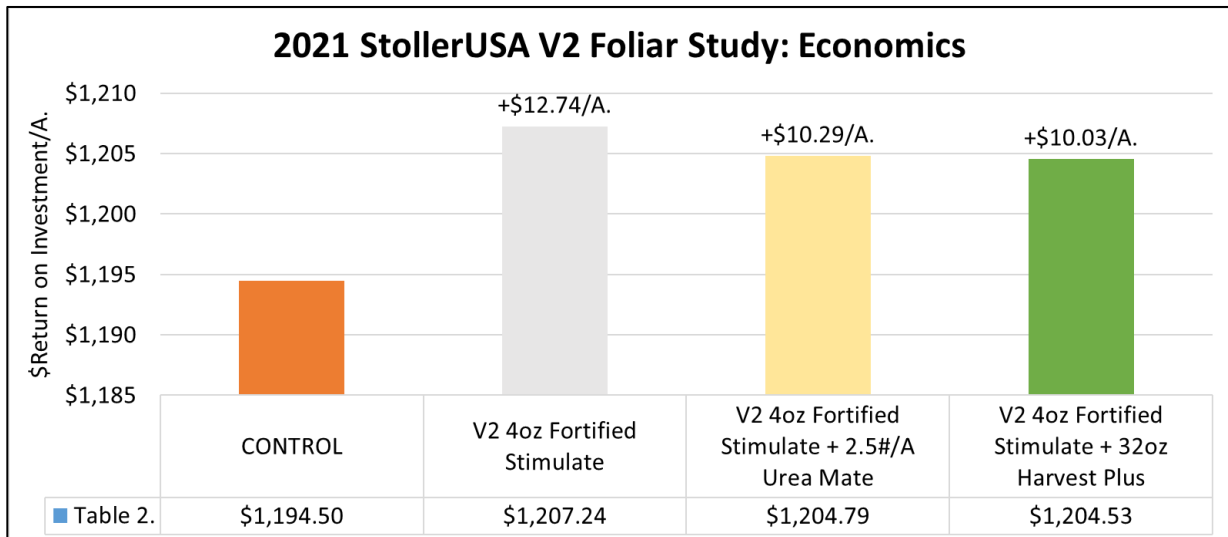
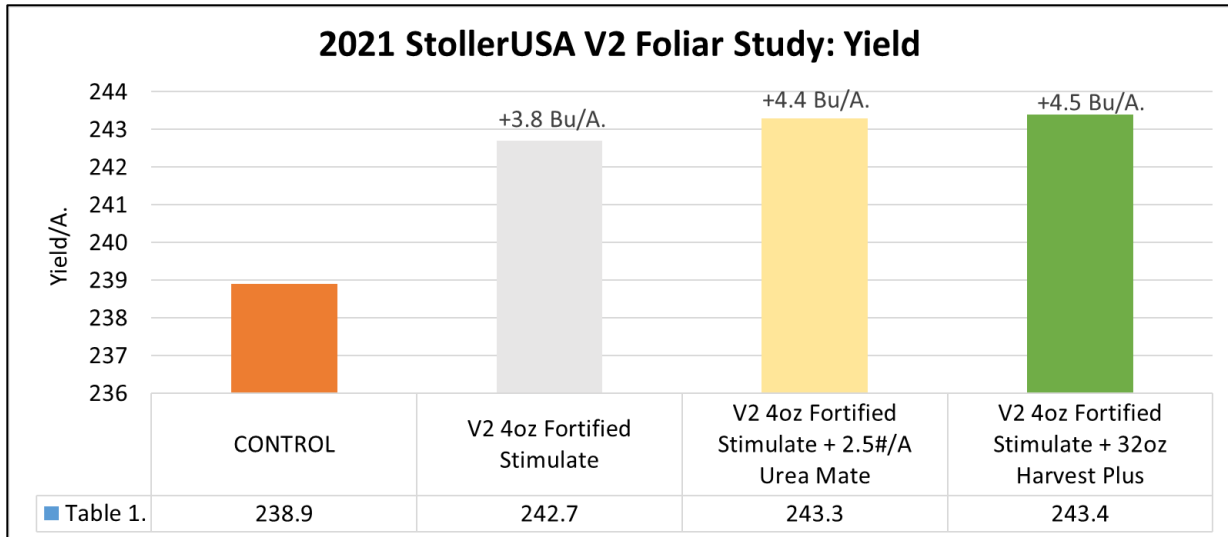


Table 2. reveals the return on investment of all three foliar applications. Stand-alone V2 Fortified Stimulate applications offered the highest net return in the study at +\$12.74/A. Tank-mixing Urea Mate and Harvest resulted in lower net returns individually at +\$10.29/A. and +\$10.03/A. respectively.

Stoller®USA R1 Growth Stage Corn Foliar Application Study

Objective: To evaluate the yield and net return of Stoller®USA 's X-Cyte Plant Growth Regulator, Harvest More™ Urea Mate, Sugar Mover Premier™ and Harvest Plus applied foliar at the R1 growth stage.

X-Cyte is an EPA-registered plant growth regulator and yield stimulant and works to restore hormonal balance, improve carbohydrate storage capacity, and increase cell division in plants for enhanced uniformity, density and quality of fruit/grain.

Sugar Mover Premier™ is an EPA registered plant growth regulator and yield stimulant that increases the rate of sugar transport from leaves to flowers, ears, seeds, pods, and root storage tissue to increase available sugar and seed size for higher yield.

HARVEST MORE™ UREA MATE 5-10-27 is a complete fertilizer with both macro and micronutrients in a readily available water-soluble acidic formulation.

Harvest Plus is 8-0-0 premium liquid fertilizer that also contains 3% Sulfur, .25% Boron, 3% Manganese, and 3% Zinc.



ACTIVE INGREDIENTS:
Cytokinin, as kinetin,
based on biological activity 0.04%
OTHER INGREDIENTS:..... 99.96%
Total 100.00%
(Contains 0.0064 oz. cytokinin/pint)

CONTAINS NON-PLANT FOOD INGREDIENTS:
0.04% Cytokinin

Information regarding the contents and levels
of metals in this product is available on the internet at
<http://www.aapfco.org/metals.html>

HARVEST MORE™ UREA MATE 5-10-27

GUARANTEED ANALYSIS	
Total Nitrogen (N)	5%
5% Urea Nitrogen	
Available Phosphate (P ₂ O ₅).....	10%
Soluble Potash (K ₂ O).....	27%
Calcium (Ca).....	4%
4% Chelated Calcium	
Magnesium (Mg).....	1.5%
1.5% Chelated Magnesium	
Boron (B).....	0.15%
Cobalt (Co).....	0.008%
0.008% Chelated Cobalt	
Copper (Cu).....	0.3%
0.3% Chelated Copper	
Manganese (Mn).....	0.5%
0.5% Chelated Manganese	
Molybdenum (Mo).....	0.008%
Zinc (Zn).....	0.5%
0.5% Chelated Zinc	

Plant nutrients derived from urea phosphate, potassium chloride, urea, boric acid, sodium molybdate, calcium EDTA, magnesium EDTA, cobalt EDTA, copper EDTA, manganese EDTA and zinc EDTA.

SUGAR MOVER PREMIER™



ACTIVE INGREDIENTS:
Cytokinin, as kinetin,
based on biological activity.....0.003%
INERT INGREDIENTS.....99.997%
TOTAL..... 100.00%

(Contains approx. 0.018g Cytokinin/pint)
CONTAINS NON-PLANT FOOD INGREDIENT: 0.003% Cytokinin

Harvest Plus

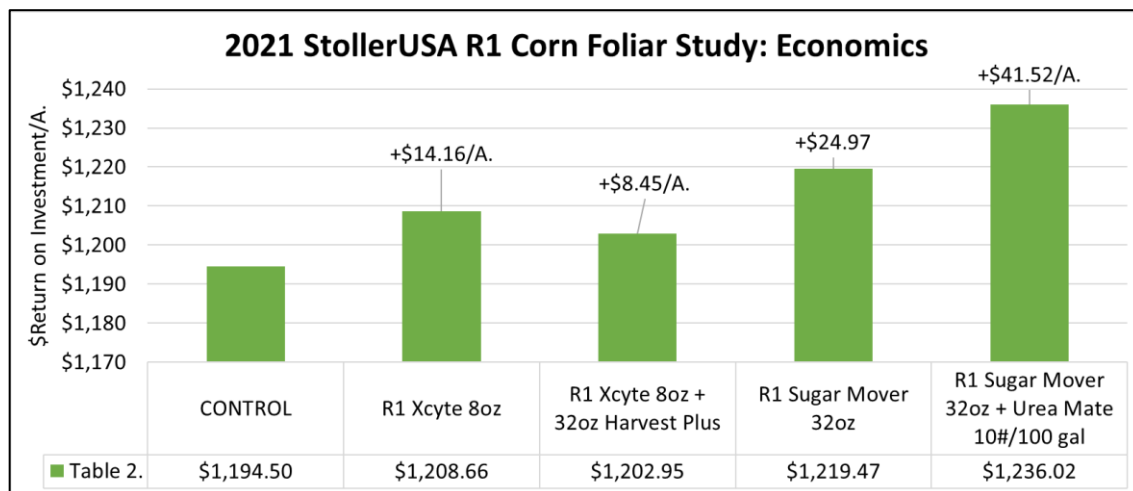
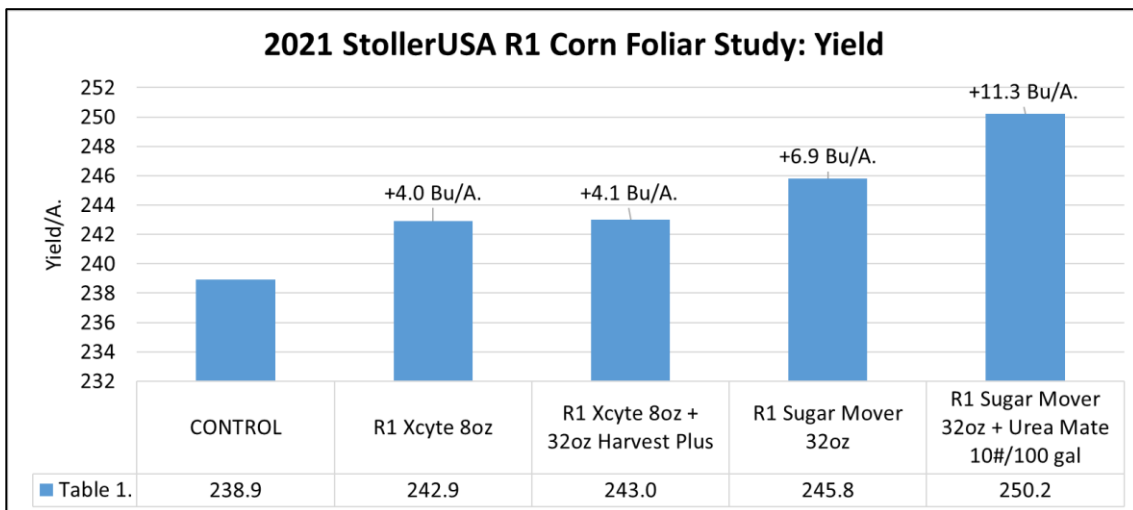
8-0-0 Enhanced Micro Blend GUARANTEED ANALYSIS	
Total Nitrogen (N).....	8%
8% Ammoniacal Nitrogen (N)	
Sulfur (S).....	3%
3% Combined Sulfur (S)	
Boron (B).....	0.25%
Manganese (Mn).....	3%
3% Chelated Manganese (Mn)	
Zinc (Zn).....	3%
3% Chelated Zinc (Zn)	

Derived from aqueous ammonia, boric acid, manganese sulfate and zinc sulfate chelated with citric acid

Stoller®USA R1 Growth Stage Foliar Application Study Continued

Results: Table 1. illustrates applications of Sugar Mover and Urea Mate offered the highest yield gains in this study. Individual Sugar Mover resulted in +6.9 Bu/A. yield responses and Urea Mate tank-mix added an additional +4.4 Bu/A. These R1 treatments achieved a positive return on investment of +\$24.97 and +\$41.52 respectively. (Table 2.)

Table 1. also illustrates X-Cyte treatments resulted in average yield gains of +4.0 Bu/A. and when Harvest Plus was tank-mixed along with X-Cyte, yield was improved by only +0.1 Bu/A. Although these yield results were lower than the Sugar Mover/Urea Mate offering, these R1 treatments did in fact result in positive economic gains of +\$8.45/A. to +\$14.16/A. (Table 2.)




Planting Date: 5/10 Hybrid: Integra 6342 Population: 36K Row Width: 30" Rotation: CAB Corn Price: \$5

Sugar Mover Premier: \$9.53/A. Harvest More Urea Mate: \$5.45/A. Harvest Plus: \$6.21/A. X-Cyte: \$5.84/A.

Corn Veltyma™ Foliar Fungicide Study

Objective: To evaluate the yield and net return of Veltyma™ fungicide. Veltyma contains Revysol®, which is a DeMethylation Inhibitor (DMI) fungicide that is part of the triazole group of fungicides initially labeled for 17 crops, including corn and soybeans. Veltyma gives excellent control of anthracnose, eye spot, gray leaf spot, northern corn leaf blight, southern corn leaf blight, common rust, southern rust, and tar spot. Veltyma has a label which expands the window of application from V10-R3.



Active Ingredients*:
 mefenftruconazole: 2-[4-(4-chlorophenoxy)-2-(trifluoromethyl)phenyl]-1-(1H-1,2,4-triazole-1-yl)propan-2-ol 17.56%
 pyraclostrobin: (carbamic acid, [2-[[[1-(4-chlorophenyl)-1H-pyrazol-3-yl]oxy]methyl]phenyl]methoxy-, methyl ester) 17.56%
Other Ingredients: 64.88%
Total: 100.00%

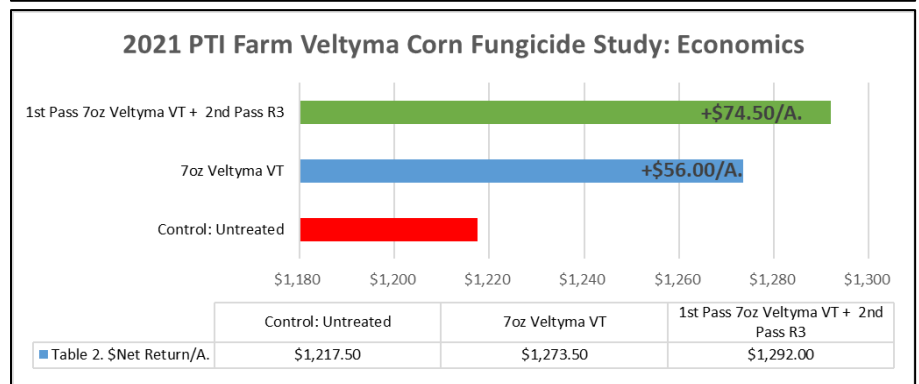
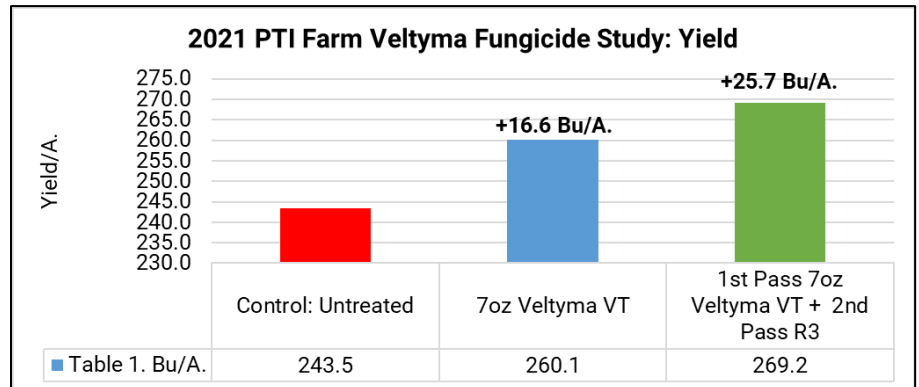
*Veltyma™ fungicide contains 1.67 lbs mefenftruconazole and 1.67 lbs pyraclostrobin per gallon.
 EPA Reg. No. 7969-409 EPA Est. No.

Mefenftruconazole	Group	3	Fungicide
Pyraclostrobin	Group	11	Fungicide

Results: Table 1. illustrates that VT foliar applications of Veltyma resulted in yield gains of +16.6 Bu/A. at the VT growth stage and +25.7 Bu/A. when sprayed at a 2nd pass at R3. This plot had significant levels of tar spot, which no doubt could be a foreseeable problem in years ahead in corn production.

After cost of application and fungicide, using a \$5.00 corn price, Veltyma proved positive net returns of +\$56.00A. at VT and 2nd pass R3 treatments did prove profitable at +\$74.50/A. (Table 2).

Figure 1. Tar Spot in Corn



Planting Date: 4/17 Hybrid: Integra 6061 Pop: 36K Row Width: 30" Rotation: CAC Corn Price: \$5.00 Veltyma+App: \$27/A.

Corn Topguard® Foliar Fungicide Study

Objective: To evaluate the yield and net return of Topguard fungicide. Topguard contains flutriafol, which is a Group 3 highly systemic fungicide with translaminar activity that protects the sprayed leaf throughout growing season to help prevent additional disease from developing. Topguard fungicide provides long lasting residual protection in corn and protects against key diseases including anthracnose, cercospera leaf blight, frogeye leaf spot, rusts, leaf blights, powdery mildew and tar spot.

Results: Table 1 illustrates that V10 foliar applications of Topguard resulted in yield gains of +11.9 Bu/A. at the V10 growth stage, +19.1 Bu/A. at the VT growth stage. Due to the presence of tar spot disease, a 2nd fungicide application was made at R3, resulting in positive yield gains of +32.3 Bu/A.

Table 2. reveals economics of all treatments. After cost of application and fungicide, using a \$5.00 corn price, Topguard EQ proved positive net returns of +\$34.50A. at V10, +\$70.50 at VT and 2nd pass R3 treatments did prove profitable at +\$111.50/A.



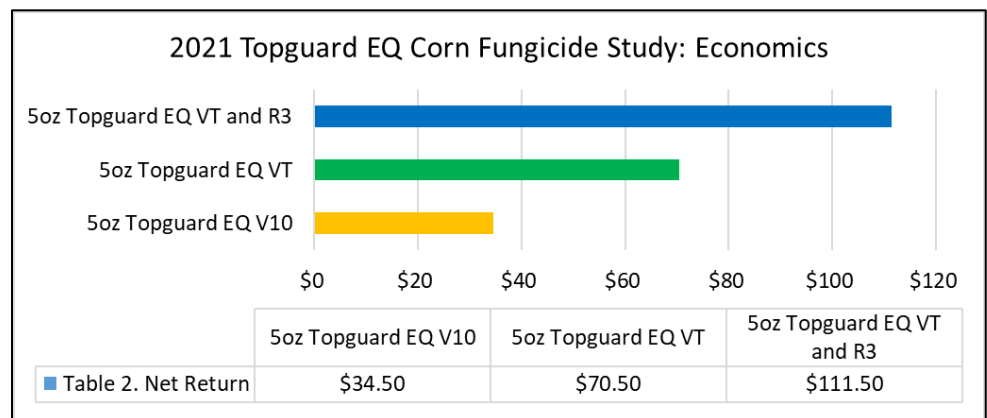
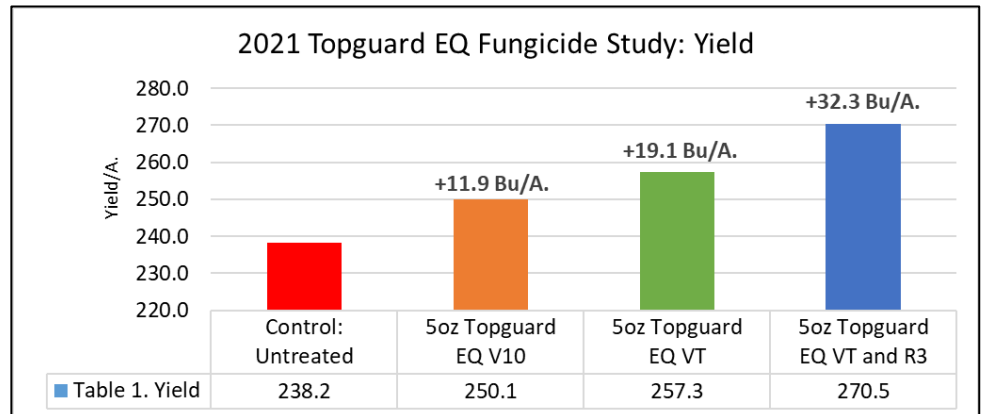
For use on barley, corn (field corn, field corn grown for seed, sweet corn and popcorn); cotton (foliar application only); vegetables, cucurbit, group 9 (excluding muskmelons); vegetables, fruiting, group 8-10; peanut; grain sorghum; soybean; sugar beet; pecan and other tree nuts; triticale; wheat (spring and winter).

EPA Reg. No. 279-3557

EPA Est. No. 70815-GA-001

ACTIVE INGREDIENT:	By Wt.
*Flutriafol	11.80%
OTHER INGREDIENTS:	88.20%
TOTAL:	100.00%

*Contains 1.04 pounds per gallon of the active ingredient flutriafol. Suspension concentrate.



Miravis Neo™ Corn Foliar Fungicide Study



Objective: To evaluate the yield and economics of a Miravis®Neo in corn.



ADEPIDYN® Technology*

Active Ingredients:

Pydiflumetofen** 7.0%

Azoxystrobin*** 9.3%

Propiconazole**** 11.6%

Other Ingredients: 72.1%

Total: 100.0%

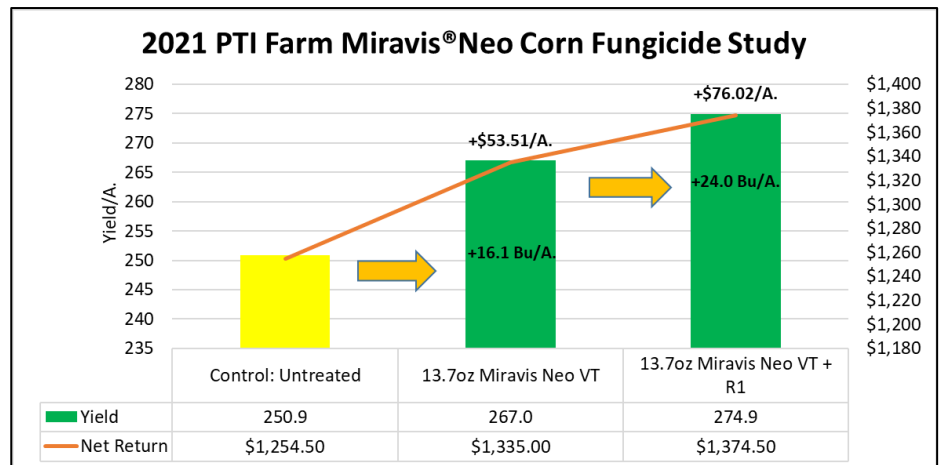
MiravisNeo fungicide combines propiconazole, azoxystrobin and Adepidyn technology – one of the most powerful, broad spectrum SDHI molecules available, and delivers superior plant-health benefits and improved preventive and curative control of key diseases such as Gray Leaf Spot, Common and Southern Rust, Tar Spot, Eye Spot, Anthracnose, Diplodia Ear Rot, and Physoderma Brown Spot.



PYDIFLUMETOFEN	GROUP	7	FUNGICIDE
PROPICONAZOLE	GROUP	3	FUNGICIDE
AZOXYSTROBIN	GROUP	11	FUNGICIDE

Results: Due to heavy tar spot infestations, MiravisNeo treatments at VT growth stage proved yield gains of +16.1 Bu/A. with positive economic returns of +\$53.51/A.

A sequential treatment again at R1, proved additional yield gains of +7.9 Bu/A. and positive return on investment of +\$22.41/A. over single VT treatments.



Fungicide Ground vs. UAV Foliar Spray Application Study

Objective: To evaluate the yield and net return of Trivapro® fungicide applied at VT growth stage.

2021 was a historical year for corn fungicide applications, due to a major out-break in tar spot disease (Figure 2.) Efforts at the PTI Farm were made to protect corn from this damaging disease and multiple application types were implemented for fungicide application. This study evaluates a traditional ground fungicide application with a Hagie™ high-clearance sprayer, at a carrier rate of 15 Gal/A. Additionally, the use of a Rantizo® MG-1P spray UAV was also evaluated at carrier rates of 3 Gal/A. (Figure 2).



SOLATENOL® Technology*

*Technology denotes the active ingredient, Benzovindiflupyr.

Active Ingredients:

Benzovindiflupyr** : 2.9%

Azoxystrobin*** : 10.5%

Propiconazole**** : 11.9%

Other Ingredients: 74.7%

Total: 100.0%

Trivapro® fungicide is a fungicide for corn, soybeans, and wheat. It contains three robust active ingredients including Solatenol® fungicide, azoxystrobin and propiconazole. Trivapro is a fungicide product that offers both preventive and curative disease control.



Figure 1. Hagie™ Ground Sprayer and Rantizo® MG-1P Spray UAV



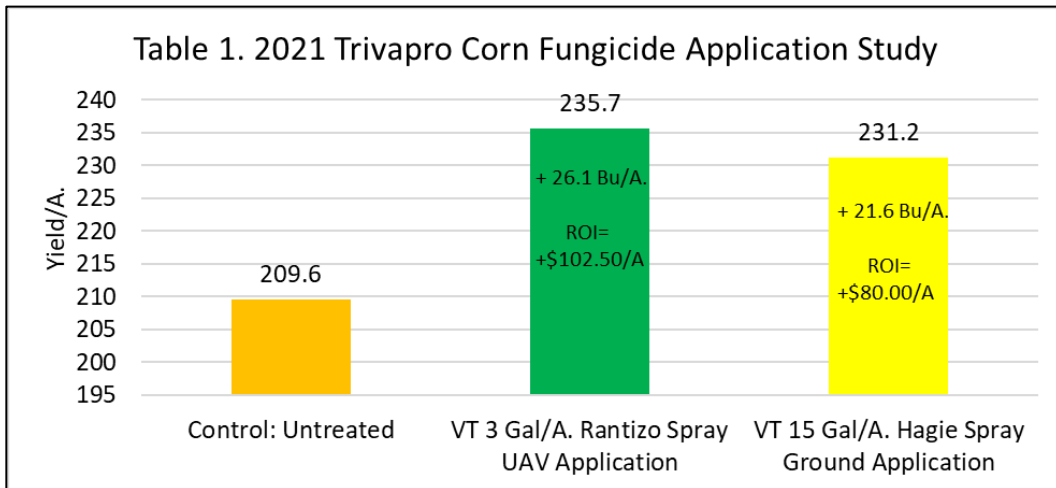
Figure 2. Tar Spot in Corn

Fungicide Ground vs. UAV Spray Application Study Continued

Results: Table 1 illustrates that VT foliar applications of Trivapro resulted in impressive yield gains of +21.6 to +26.1 Bu/A. As mentioned earlier, this plot had significant levels of tar spot, which no doubt could be a foreseeable problem in years ahead and will have to be managed diligently.

Table 1. also reflects the difference in yield and return on investment by application type. As a new technology in the marketplace, the Rantizo spray UAV did in fact offer yield advantages over ground application by +4.5 Bu/A. After cost of application and fungicide, using a \$5.00 corn price, Rantizo spray UAV applications proved positive net returns of +\$22.50A. compared to traditional ground application.

In our 1st year of evaluating spray UAV applications, it does appear that this technology is an effective method to apply crop protection products. Advantages to this technology include precise application due to downward propeller air movement, low carrier rates, the absence of ground or soil engagement, and the ability to spray in fields with topography challenges.



Planting Date: 5/2 Hybrid: DKC 65-95 Pop: 36K Row Width: 30" Rotation: CAB Corn Price: \$5.00 Trivapro+App: \$28/A.

Source™ Foliar Application Study

Objective: To evaluate the yield, economics, and nitrogen efficiency of Source, a foliar-applied nutrient efficiency product that increases plant-available nitrogen and phosphorus to support healthier plants and improved productivity. Source activates nitrogen fixing bacteria, which turns atmospheric nitrogen into a plant available form.



Source was applied by a Rantizo spray un-manned ag vehicle (UAV) (Figure 1.) at a rate of 0.7 fl oz/A. at the VT growth stage with 3 Gal/A. water carrier.

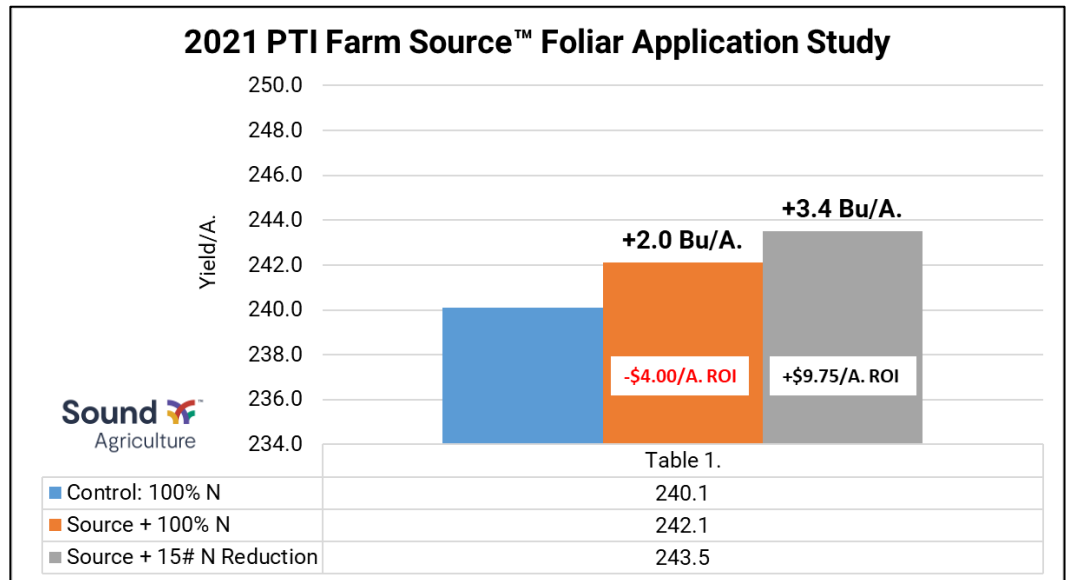
Figure 1. Rantizo UAV



Due to its nitrogen efficiency, Source was applied in conjunction with 100% rates of N (240# N) as well as a 15# N reduction (225#).

Results: Table 1. illustrates applications of Source resulted in +2.0 Bu/A. yield gains and a negative return on investment of **-\$4.00/A.** when applied with normal 100% nitrogen rates. When nitrogen was reduced by 15#/A., the yield response of Source increased to +3.4 Bu/A. with a positive return on investment of **+\$9.75/A.**

With current nitrogen prices being at near all-time highs, if proven successful, nitrogen use efficiency products could be a viable option to help lower overall nitrogen costs, allow lower applied nitrogen rates, all without sacrificing yield. We look forward to more research with Source in the future at the PTI Farm.



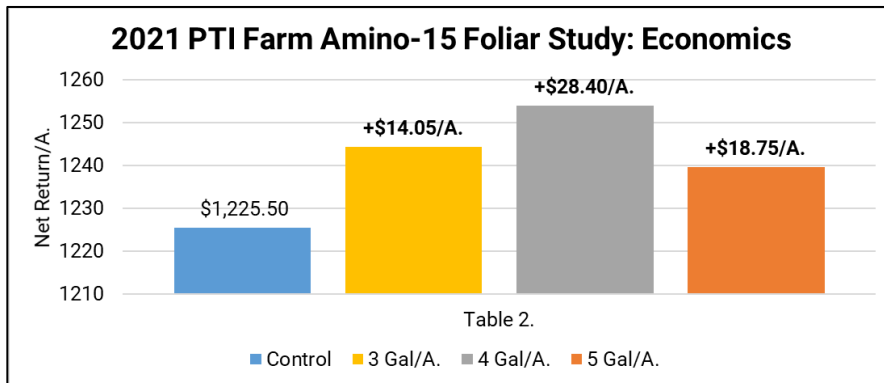
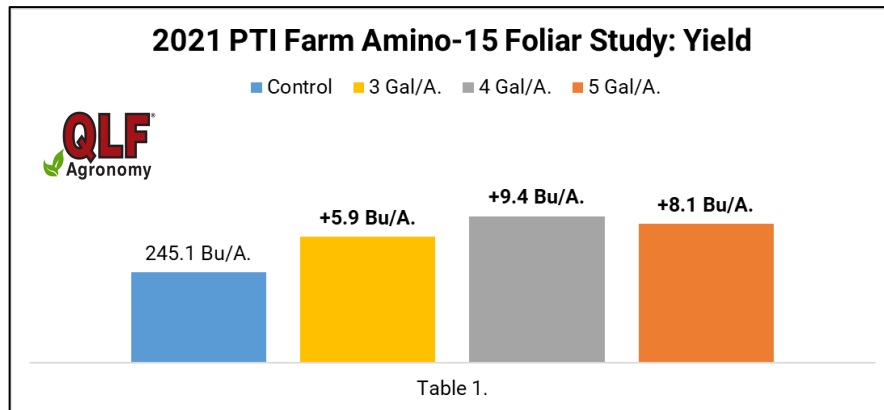
QLF L-CBF Amino 15-0-1 Foliar Study

Objective: To evaluate yield and net return of QLF Agronomy’s Liquid Carbon-Based Fertilizer (L-CBF) Amino 15-0-1 applied foliar at the VT growth stage.

Amino 15-0-1 is a balanced source of foliar nitrogen with available carbon in a low pH chemistry package. L-CBF Amino 15-0-1 has 10% sugar. For every gallon, a full pound of sugar is delivered in a microscopic form, raw and undegraded, further enhancing the adjuvant characteristics of this liquid fertilizer blend.

Derived from sugar cane molasses with an added fermentation yeast extract for enhanced biological function and paired with high quality Urea solution and L-Amino Acid forms of nitrogen, L-CBF Amino 15-0-1 is a safer and more efficient approach to foliar nitrogen applications and plant protein formation.

Results: All rates of Amino-15 proved positive, however 4 Gal/A. rates at VT growth stage resulted in economic optimum rate at +9.4 Bu/A. with a positive return on investment of +\$28.40/A.

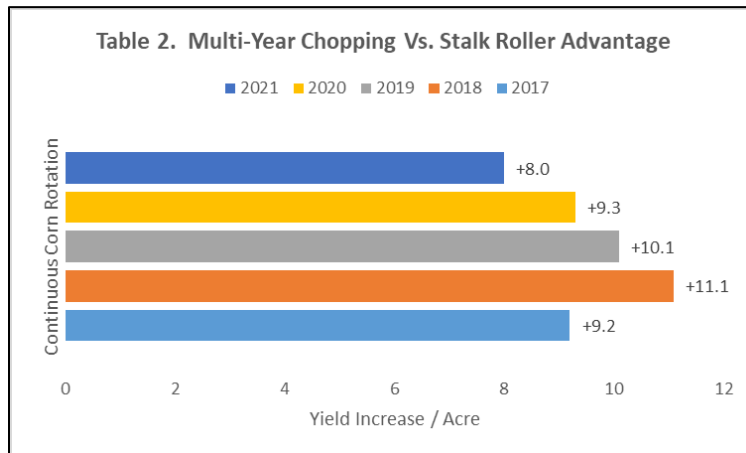
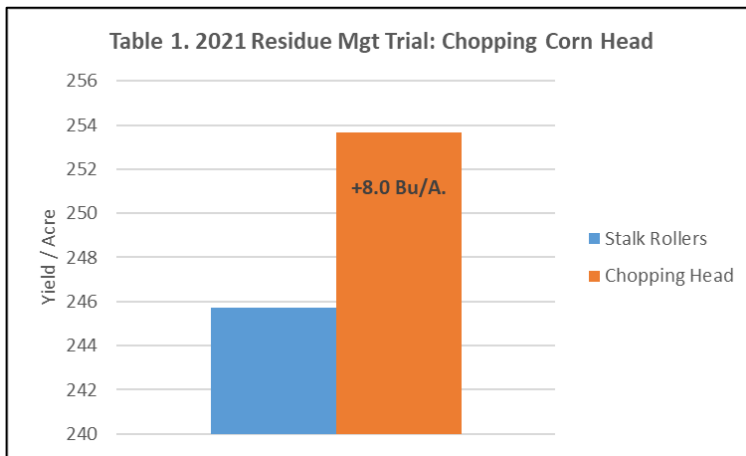


Chopping Corn Head Study

Objective: To study the yield impact of utilizing a chopping corn head in a continuous corn conventional tillage rotation. A Capello Quasar™ chopping head is used to create replicated strips of chop and non-chop residue management trials. The goal of this trial is to evaluate sizing of residue, allowing heavy stalks and residue to break down faster to advance the degradation process and in turn, reducing the carbon penalty associated with continuous corn environment.

Results: Table 1. illustrates that chopping corn residue improved corn yields by +8.0 Bu/A. and increased gross revenue by +\$40.00/A. at a corn commodity price of \$5.00/Bu.

Multi-year data from 2017-2021 indicates consistent results with chopping advantages of +9.2, +11.1, +10.1, +9.3 and +8.0 Bu/A. respectively.



SCiO™ Pocket Molecular Sensor Study

Objective: This study evaluates a new quick and easy grain moisture sensor called SCiO (Figure 1.). The SCiO is a pocket sized, Bluetooth, micro-spectrometer that has the ability to measure moisture of shelled or unshelled grain. It’s an in-field scouting tool that wirelessly connects to your smartphone via Bluetooth, to provide quick and accurate moisture readings.

Once the SCiO is connected, it can then be placed directly on the grain for moisture calculation. Five readings must be collected for every moisture SCiO scan.

For this agronomic experiment, we compared the SCiO to a commonly used handheld DICKEY-john Mini-GAC plus (Figure 4).

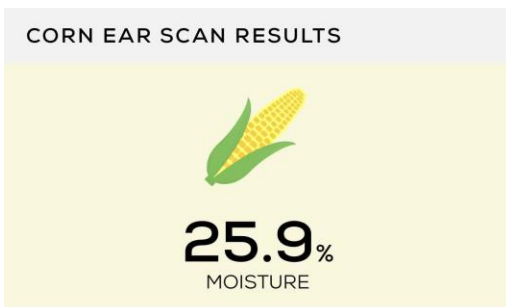
Moisture readings can be done easily in the field without lugging large equipment or even hand-shelling ears. Using your smartphone in tandem with the SCiO, a grower can add notes and save moisture readings with the app (Figure 2-3.).



Figure 1. SCiO™ in field scouting tool



Figure 2. SCiO™ smartphone app



Planting Date Study
DKC 65-94
[Edit](#)



SCiO™ Pocket Molecular Sensor Study

Results: This year we evaluated the SCiO and the DICKY-john Mini GAC-plus and compared the results to baseline grain moisture sample performed by a local grain terminal near PTI. This baseline was used as our control moisture sample (14.6%), we then ran 18 sample analysis tests from each moisture tester to evaluate over-all performance and accuracy. Some advantages to the SCiO are:

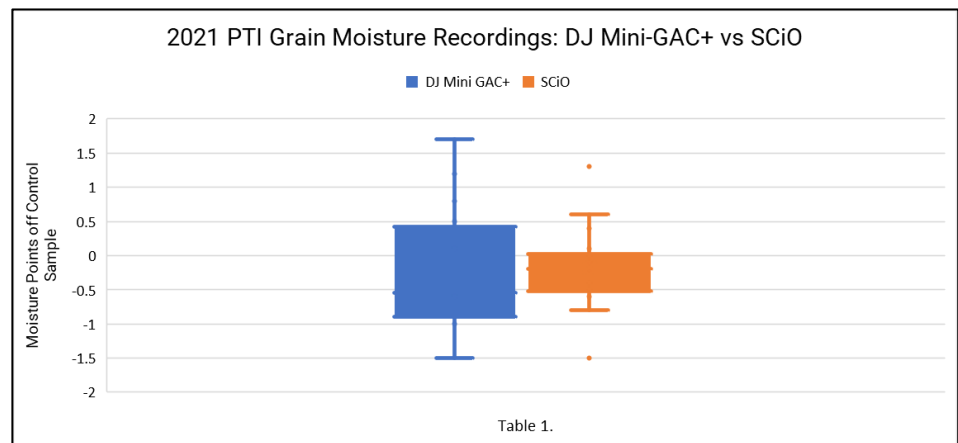
- Small, can fit in your pocket
- Accurate
- Easy to use
- Can use on whole ears in the field

Figure 4. DICKY-john Mini-GAC® plus



Table 1. illustrates the moisture readings from both DJ mini-GAC+ and the SCiO. Both moisture testers predicted an accurate moisture reading from the grain terminal within 0.4pts of grain moisture. The graph shows what the majority of the moisture readings were, as well as the range from both devices. the most notable difference between the two grain moisture testers was the range and percentage error of all 18 sample readings. The DICKY-john mini-GAC plus did accurately predict the same moisture as our baseline sample, however the average percentage error off the control is where the SCiO showed more consistent accuracy. The DJ mini-GAC plus had an average percentage difference of 5.3% where the SCiO only had a percentage difference of 3.1%.

This product started testing at the PTI Farm in 2019, the SCiO was an excellent tool to use in the field and looked very promising. After using the SCiO again in 2020, and now in 2021, we've had tremendous performance and accuracy. We look forward to using this tool throughout future growing seasons.



Corn Tillage Study

Objective: To evaluate the yield and economic impacts of various tillage programs in a corn after soybean rotation. Tillage programs include conventional till, strip-till, vertical till, no-till and in-line rip.

Figure 1. Sunflower® 6833 Vertical Tillage



Figure 3. Kuhn® Krause Gladiator



Figure 6. Sunflower® 4630 Disc Ripper



Figure 2. Planting in No-Till



Figure 5. Sunflower 4608 In-Line Ripper



Tillage Practice	Category	Cost
Conventional Till	Disk Ripper	\$ 27.70
	Soil Finisher	\$ 13.60
	Plant	\$ 17.20
	Total:	\$ 58.50
Strip Till	Strip	\$ 17.30
	Burndown	\$ 8.00
	Plant	\$ 17.20
	Total:	\$ 42.50
Vertical Till	Vertical	\$ 13.20
	Burndown	\$ 8.00
	Plant	\$ 17.20
	Total:	\$ 38.40
No Till	Burndown	\$ 8.00
	Plant	\$ 19.00
	Total:	\$ 27.00
In-Line Ripper	V-ripper	\$ 23.40
	Soil Finisher	\$ 13.60
	Plant	\$ 19.00
	Total	\$ 56.00

Table 1. Univ. of IL Machinery Cost Estimates

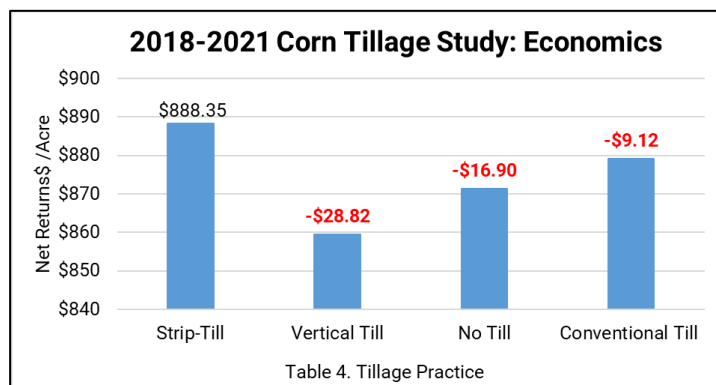
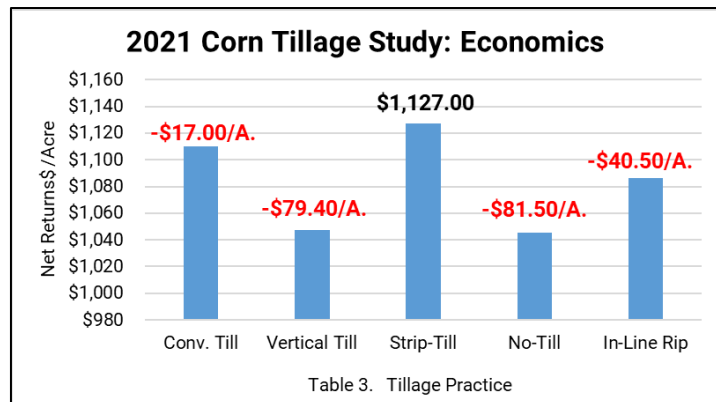
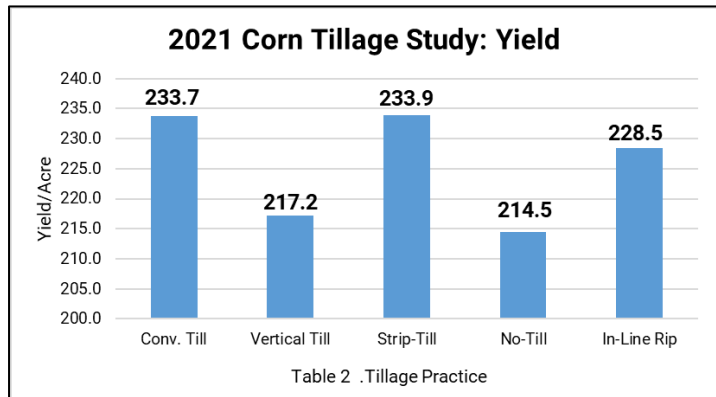
Corn Tillage Study Continued

Results: To understand both yield and economics, the University of Illinois Machinery Cost Estimate Summary is used to calculate individual cost of each tillage program (Table 1). For the three reduced tillage programs, an \$8/A. burn-down is also included.

Table 2. illustrates the overall yield for each tillage segment. The yields varied 19.4 Bu/A. between all tillage programs with strip-till and conventional till offering the highest yields of 233.9 and 233.7 Bu/A. respectively.

After applying all appropriate costs to each individual tillage segment, strip-till offered the highest overall revenue in this tillage system study in 2021. Compared to strip-till, no-till offered losses of **-\$81.50/A.**, vertical tillage **-\$79.40/A.**, in-line ripping losses of **-\$40.50/A.** and finally conventional tillage at **-\$17.00/A.** (Table 3.)

Table 4. illustrates multi-year data from the PTI Farm in 2018-2021. Strip-till over this time frame has provided the highest overall net returns, with conventional till behind by **-\$9.12/A.** Vertical and no-till have resulted in losses of **-\$28.82** and **-\$16.90/A.** respectively.



Finish Line™ Sweep Study

Objective: To evaluate the yield and economic impacts of Finish Line™ Sweeps (Figure 1.), a field cultivator shovel that features a knife blade on the underside of the shovel designed to create a narrow slit below operating depth to fracture the soil density layer created by horizontal tillage systems.

Typical field cultivator sweeps lift and till the soil above them but compact the soil below by creating a soil density layer at the lift point. Soil density is a form of soil compaction that occurs when soil particles press together, reducing pore space between them, consequently creating a greater density.

Compacted soils have a reduced rate of both water infiltration and drainage because large pores more effectively move water downward through the soil than smaller pores. This combination typically results in lower usable plant water and nutrition uptake, due to smaller root size and overall mass.

Figure 1. Traditional Cultivator Sweep



Figure 2. Finish™ Line Cultivator Sweep



Figure 3. Finish™ Line Sweeps on 9" Spacing



Figure 4. Finish™ Line Sweeps on 9" Spacing

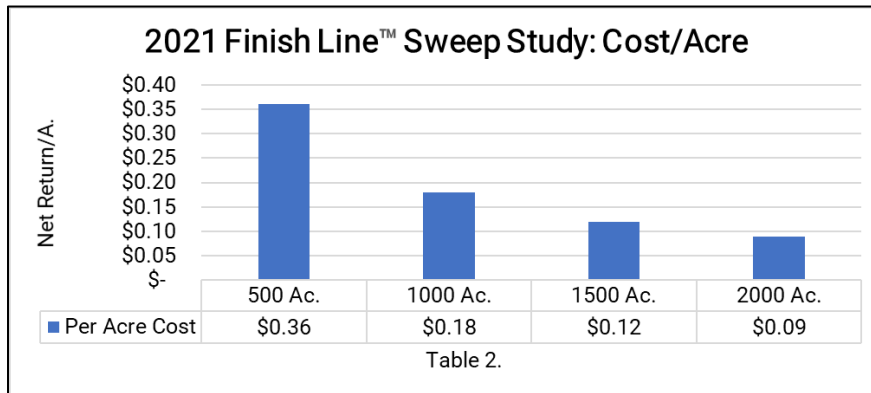
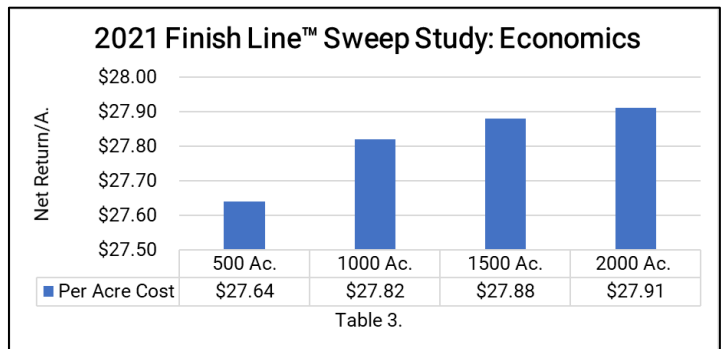
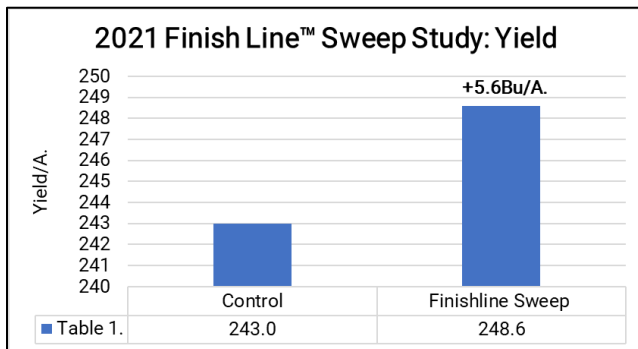


Finish Line™ Sweep Study Continued:

Results: Finish Line sweeps offered +5.6 Bu/A. yield gains over traditional cultivator shovels in our second year of testing this product (Table 1). Table 2 illustrates the cost of FinishLine sweeps using a \$4 cost over and above standard shovels. The PTI team installed 45 Finish Line sweeps on a 30' 6833 Sunflower® Land Finisher (Figures 3 and 5) for a total additional cost of only \$180 over standard sweeps. Farm sizes of 500 to 2000 acres would range in cost from only \$0.36/A. to \$0.09/A.

Table 3. summarizes return on investment of +\$27.64 to +\$27.91/A., dependent on total farm size acreage.

Figure 5. Fendt® 1042 Tractor on Sunflower® 6833 Land Finisher



Planting Date: 5/19 Hybrid: DKC59-82 Population: 36k Row Width: 30" Rotation: CAB Corn Price: \$5.00

Yetter Strip Freshener™ Study

Objective: To evaluate Yetter 2984 strip fresheners to facilitate consistent soil warming and bring existing strips to life. Original fall strips made in October after harvest were freshened in April before planting (Figure 1).

Figure 1. Yetter 2984 Strip Freshener

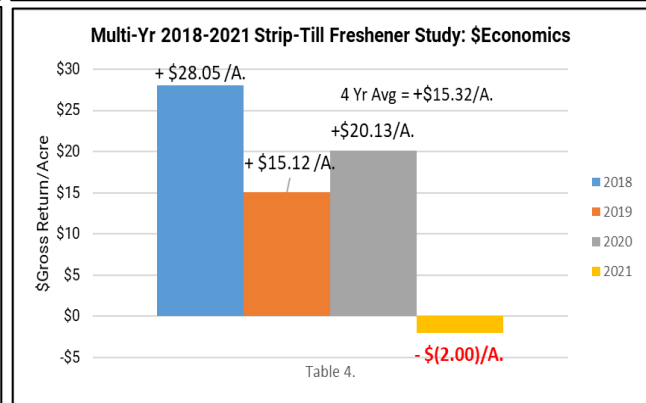
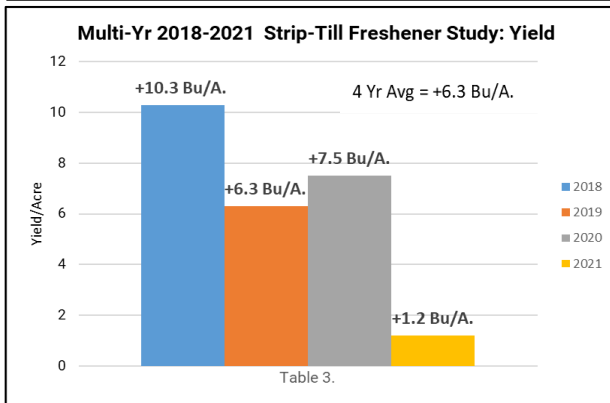
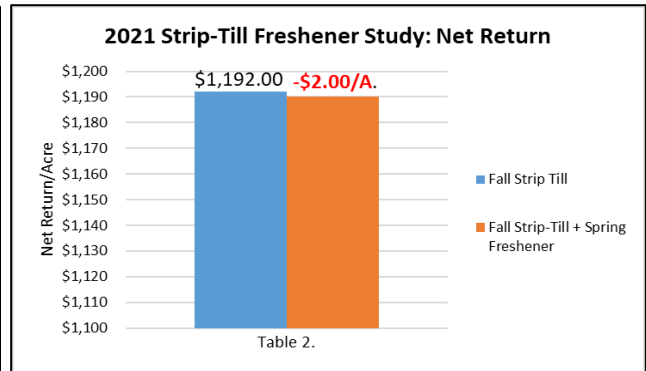
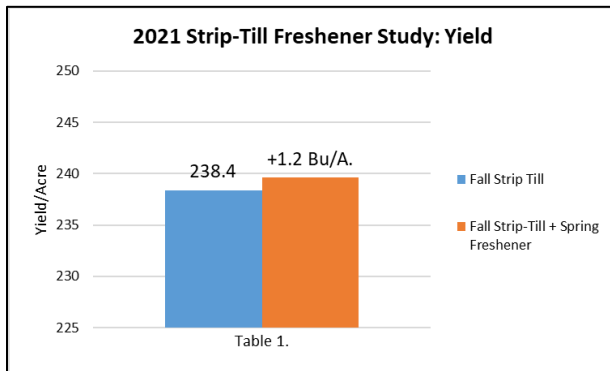


Features:

- 3-blade arrangement with rolling basket to condition strips
- Operates at 6 to 10 mph and 1 1/2" to 4" deep, depending on depth setting
- Precision Planting CleanSweep® residue managers to clean rows while building strip

Results: Spring strip freshening increased yield by an average of +1.2 Bu/A. and resulted in net losses of **-\$2.00/A.**, using a custom cost of \$8/A. for calculating charge of application.

Tables 1-2. illustrate multi-year 2018-2021 average yield gains of +6.3 Bu/A. with net positive economic gains of +\$15.32/A.

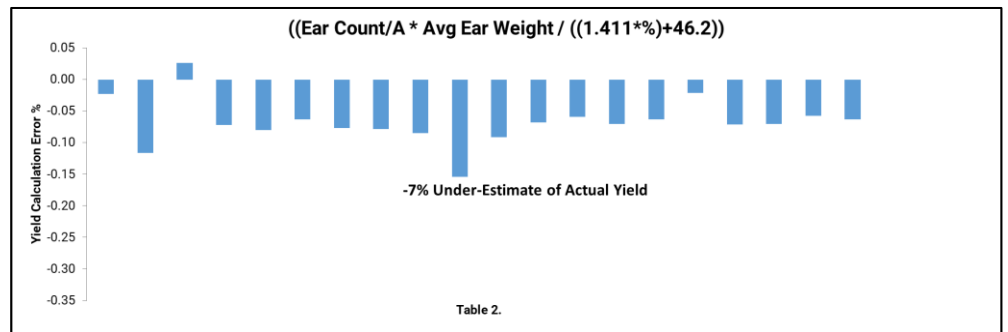
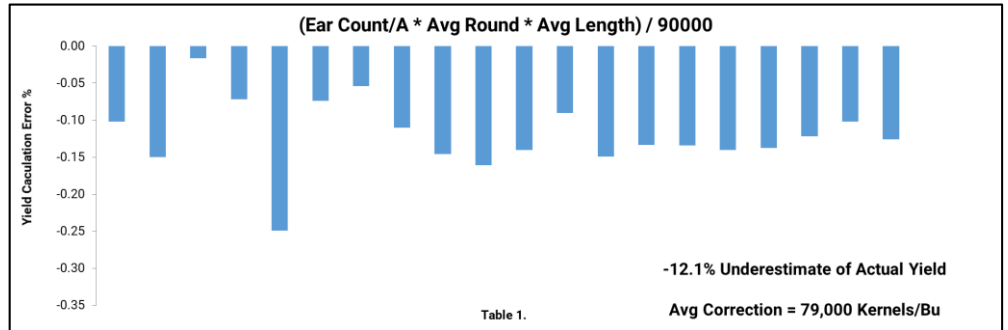


Planting Date: 3/28 Hybrid: GH 10D21 Population: 36K Row Width: 30" Rotation: CAC Corn Price: \$5.00

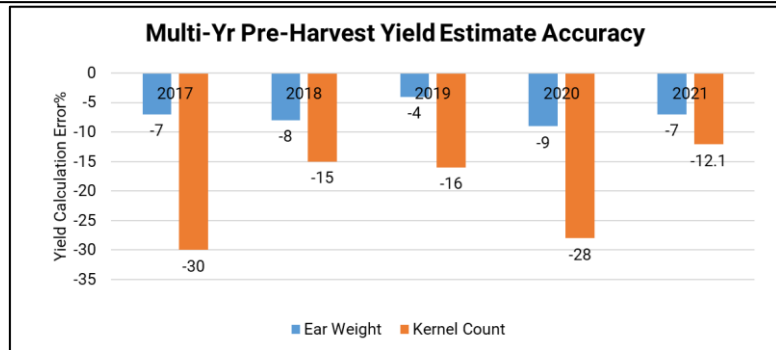
Pre-Harvest Yield Estimation Study

Objective: To calculate pre-harvest yield estimations and compare the accuracy levels of ear weight/moisture versus kernels/Bu. formulas.

A common method used to perform pre-harvest yield estimations has been to calculate ear count multiplied by average kernels round, multiplied by average kernels in length, and divided by the number of kernels of a bushel of corn (Table 1). The problem with this method has been that determining the number of kernels in a bushel of corn varies with different genetics due to size and weight of grain. Corn genetics can vary from hybrid to hybrid and even weather can commonly cause inconsistent test weights and kernel depth from one location to another.



Another pre-harvest yield estimate method is to calculate ear count multiplied by the actual average weight of the ears (Table 2). Since a portion of the ear weight is water from the moisture level of the grain, a moisture reading must take place to differentiate the weight of the actual grain. This calculation accounts for the weight of the grain and more closely depicts yield estimation.



Results: 20 corn hybrids evaluated in this study indicate that using the traditional kernel/Bu. method of calculating corn yield at 90,000 kernels, under-estimated yield by an average of **-12.1%**. Table 1. Illustrates the wide variance of yield calculation error varying from **-2%** to **-25%**. To correct the error, an average of 79,000 kernels should have been implemented to account for an average accurate yield range depiction. Conversely, the ear weight and moisture yield estimation method did a much better job of predicting yield within **-7%**. An interesting aspect using this formula is the very tight range of yield error (**-10%** to **+3%**), compared to the wide swings of the alternative method (Table 2.)

Over the last five years, the kernel/Bu. method has incurred average errors by **-20.2%** using the 90,000 kernels/Bu. method, while the ear weight and moisture method has proved better accuracy at **-7%**.

Soybean Table of Contents:

Soybean Planting Principles:

Planting Date	163
Starter Fertilizer Response by Date	164-165
Multi-Year Early Plant Date	166
Reveal™ Residue Management	167-168
CleanSweep® Residue Management	169-170
Downforce Management	171-173
Keeton® Seed Firmer	174
FurrowJet® Side-Wall	175
Singulation	176
Closing Wheels	177-179
FurrowForce® Auto vs Manual Control	180
Frost	192-195
STP Opening Discs	196-197
Strip Planting	198-205
Row Width & Seeding Rate	206-208
Early Planted Seeding Rate	209-210
High Speed	211
Air Seeder	212-213
Rolling	214-215
Planting Depth	248

Soybean Fertility & Pest Management:

Calcium Products 98G™	191
Cover Crop Study	216-217
Broadcast vs Banding	218-219
Broadcast vs Banding Rate Efficiency	220-221
Marco Quick Grow LTE FurrowJet®	222
Marco BioMarc FurrowJet®	223
Nachurs® Start2Finish	224
AgroLiquid® Starter Fertilizer	225
Stoller®USA FurrowJet®	226-227
QLF L-CBF Amino 15-0-1 Foliar	228
QLF L-CBF 5-5-5-1S Study	229
Stoller®USA V2 Foliar Application	233-234
Stoller®USA R3 Foliar Application	235-236
Revytek™ Foliar Fungicide	237
Miravis Neo™ Foliar Fungicide	238
Calcium Products SO4™	239
Marco Fertilizer Conceal® 14-12-4-6s	240
Nachurs® Conceal® K-Fuse® Potassium	241
L-CBF 7-21-3 MKP FurrowJet®	242
L-CBF Boost 4-0-3-2S Conceal	243

Soybean Tillage:

Soybean Tillage	245-247
-----------------	---------

Soybean Intensive Management:

High Yield Study: West	181-183
At-Plant Nutritional Study	184-185
Yield to Seeding Rate Ratio	186
Irrigation Study	187
Soybean Seed Size	188
High Yield Study: East	189-190
High Management Ocean Blue Ag	230-232

Soybean Planting Date Study

Objective: To evaluate various soybean planting dates throughout the spring to determine optimum planting date. Once optimum yield is discovered, data can then be analyzed to determine the deviation of yield at both early and late planting dates compared to traditional norms. With the recent trend of earlier soybean planting dates achieving higher yields, it is our intention to plant as early as possible in this study and plant every week throughout the spring planting season when fit.

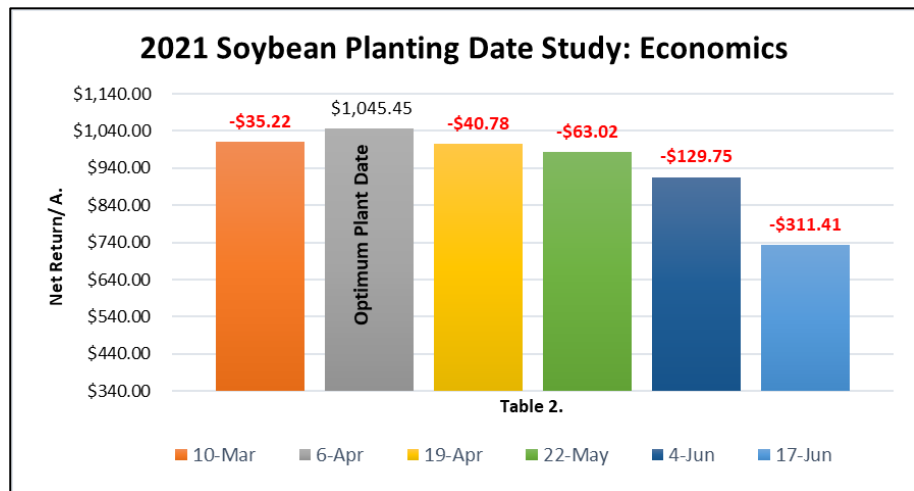
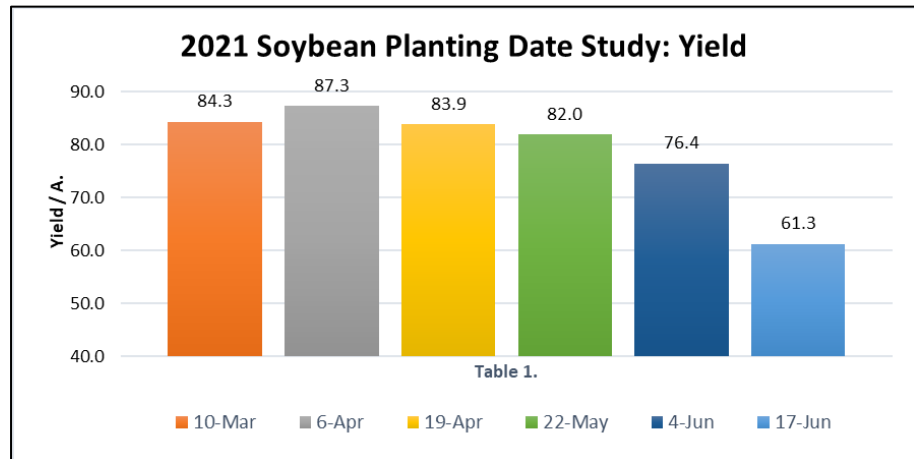
Results: Table 1. illustrates the results of six planting dates over March 10th, April 6th, April 19th, May 22nd, June 4th, and June 17th. Soybean yield varied 26 Bu/A. between all planting dates.

Optimum planting date occurred on April 6th, receiving the highest yield of 87.3 Bu/A.

Following through with what we have seen in past years, early plantings offered tremendous yield gains. The March 10th planting date (earliest we have ever planted at the PTI Farm) averaged 84.3 Bu/A. soybean yield,

while April planting dates averaged 85.6 Bu/A. As the calendar hit May, yields fell by **-5.3** to 82.0 Bu/A., June 4 fell **-10.9 Bu/A.** at 76.4 Bu/A. and June 17th plantings saw the most significant yield decrease by **-26.0 Bu/A.** at 61.3 Bu/A.

Table 2. illustrates the overall economic implications from deviating from optimum planting date and reveals net economic losses ranging from **-\$35.22/A.** to **-\$311.41/A.**



Soybean Starter Fertilizer Response by Planting Date Study

Objective: To monitor the performance of starter fertilizer at various planting dates. When does starter fertilizer give the highest returns? Does starter fertilizer respond differently at earlier planted dates versus later? In this study we evaluate six planting dates consisting of March 10th, April 6th, April 19th, May 22nd, June 4th, and June 17th with and without a starter fertilizer, monitoring its performance throughout the planting season.

The starter fertilizer program used for this study consists of the following:

<u>Product</u>	<u>Fertilizer Analysis</u>	<u>Placement of Fertilizer</u>
1 Gal/A. Triple Option®	4-13-17-1S	FurrowJet® Center
2 Gal/A. Triple Option®	4-13-17-1S	FurrowJet® Wings
3 Gal/A. K-Fuse®	Potassium Sulfate	Conceal®
5 Gal/A. Throwback®	9-27-4-4	Conceal®



Figure 1. FurrowJet® Placement

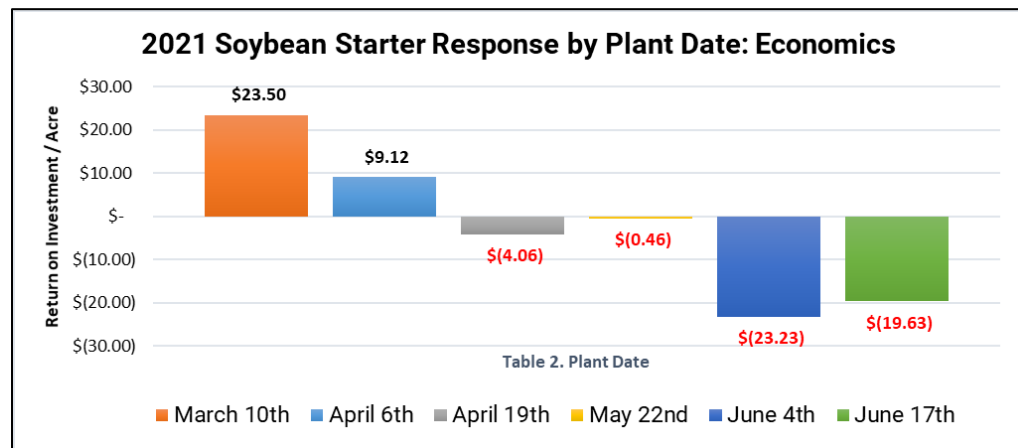
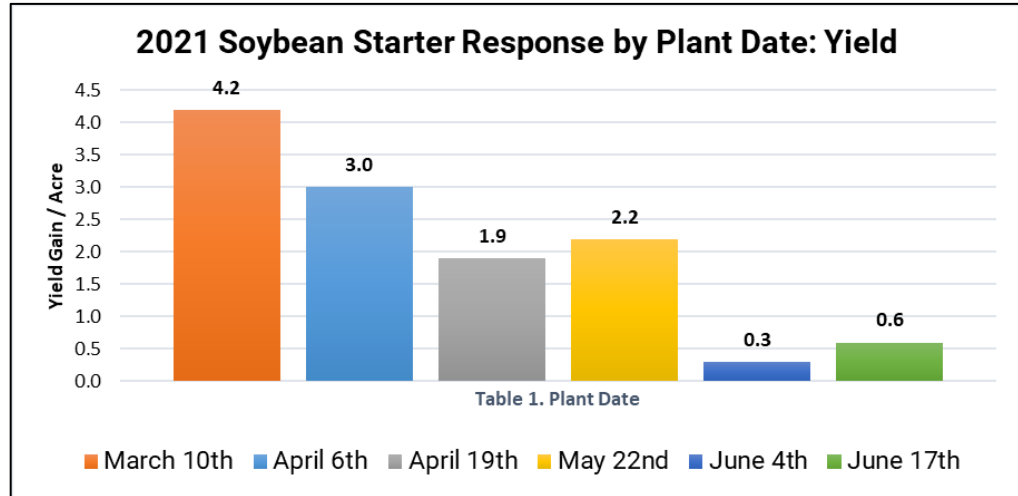


Figure 2. Conceal® Placement

Soybean Starter Fertilizer Response by Planting Date Study Continued

Results: Table 1. illustrates all starter fertilizer treatments offered yield gains at each of the six planting dates. Yield gains averaged +2.0 Bu/A., ranging 3.9 Bu/A. between all the planting dates. 2021 starter fertilizer treatments offered the highest yield gains in the early March 10th and April 6th plantings with average yield gains of +4.2 to +3.0 Bu/A. As planting dates progressed later into last half of April, May and June, yield gains fell to +0.3 Bu/A. to +2.2 Bu/A.

Table 2. focuses on net return on investment and illustrates the earliest March and April plantings offered economic gains ranging of +\$23.23 to +\$8.40/A. respectively. As planting dates progressed later, starter fertilizer returns on investment fell to losses ranging from **-\$0.87/A.** to **-\$23.11/A.**



Planting Date: Varied Variety: GH3582Enlist Population: 130K Row Width: 30" Rotation: BAC SB Price: \$11.98
 K-Fuse: \$4.80/Gal Throwback: \$5.10/Gal Triple Option: \$5.64/Gal \$30 Fertilizer Reallocation

Multi-Year Early Plant Date Soybean Study:

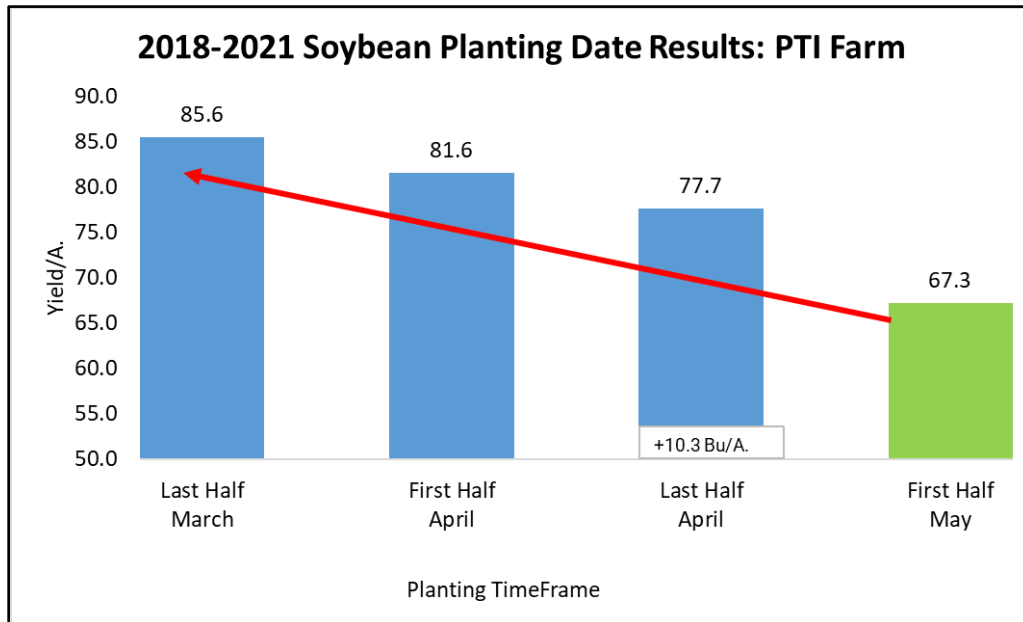
Objective: To evaluate the yield and economics of early planted soybeans compared to traditional later soybean plant dates. Pushing planting dates earlier; extends the growing season, leading to earlier flowering dates, and overall higher yield potential.

Results: Table 1 below, illustrates multi-year early planted soybean data from the PTI Farm. Traditionally, planting dates during the first half of May is very common for soybeans. However, multi-year data from 2018-2021 has proven earlier planting can result in significant yield increases.



Ultra-early planting dates in the last half of March, have accomplished +18.3 Bu/A. yield gains compared to that of traditional planting dates in the first half of May. As planting dates were made in the first half of April, yield losses of **-4.0Bu/A.** occurred, while **-8.0Bu/A.** yield losses occurred when delaying planting until the first half of May.

In general, PTI data suggests that if a grower is capable of moving planting dates earlier increased yield is obtainable if managed correctly.



Planting Date: Varied Variety: GH3582 Enlist Population: 130k Row Width: 30" Rotation: BAC Soybean Price: \$11.98

Reveal™ Residue Management Study

Objective: This study evaluates the yield and economic benefit of Reveal™ frame mounted row cleaners in a soybean after corn strip-till environment.

Residue management is a necessary part of today's operation to maximize profitability. Tougher stalks and more corn-on-corn acres mean a heavier load of residue that needs to be controlled. Residue in the seed trench competes with seedlings for moisture and can harbor diseases.

Reveal™ (Figure 1-2.) is frame mounted, so unlike other row cleaners it gets rid of that row unit chatter. It has a gauge wheel that precisely controls the depth of the cleaning tines. It also has an airbag that makes sure the depth that it's set at, stays consistent. The pressure of the airbag can be controlled on the 20|20® monitor.

In this agronomic study, Reveal™ is compared to the absence of row cleaners at the following PSI settings in Notch 1 setting:

1. Reveal 10 PSI Lift
2. Reveal 10 PSI Down
3. Reveal 15 PSI Down
4. Reveal 20 PSI Down



Figure 3. 20|20 System

Figure 1. Reveal™ System

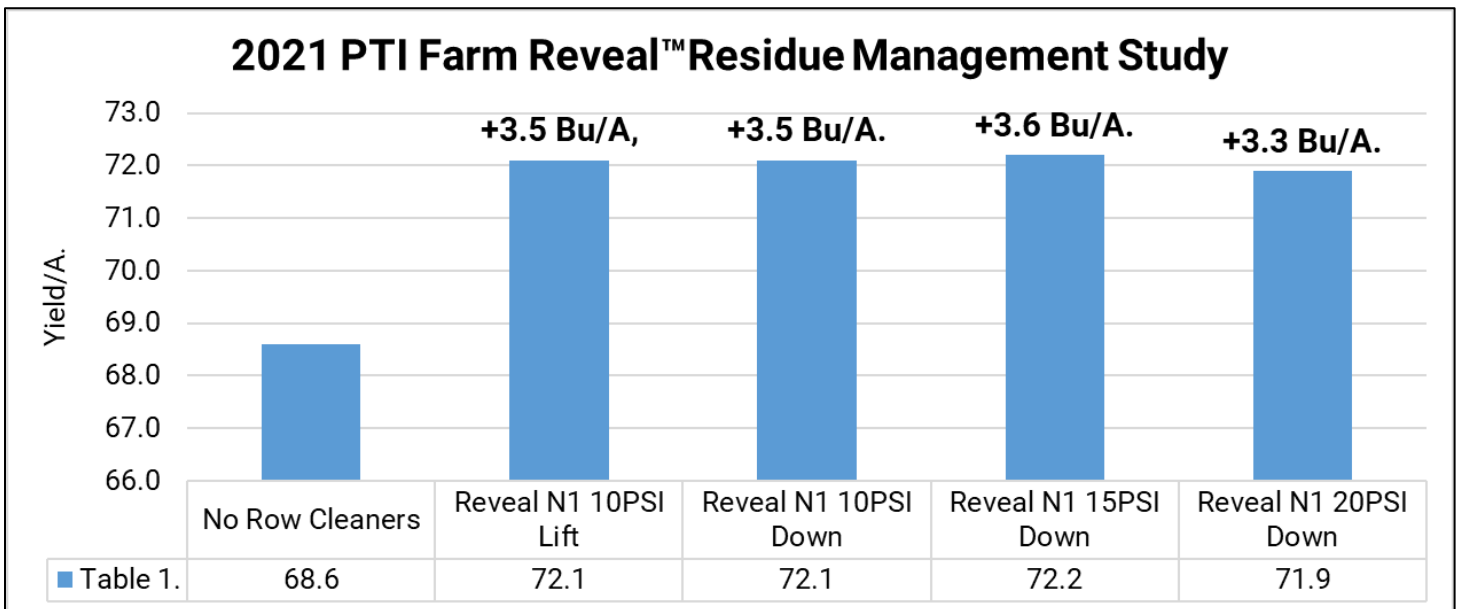


Reveal™ Residue Management System Continued

Results: Table 1. illustrates the Reveal residue management system offered an average +3.5 Bu/A. yield increase compared to the absence of row cleaners. From 10PSI lift to 20PSI down, yield difference varied only by 0.3 Bu/A.



Figure 3. Reveal™ System

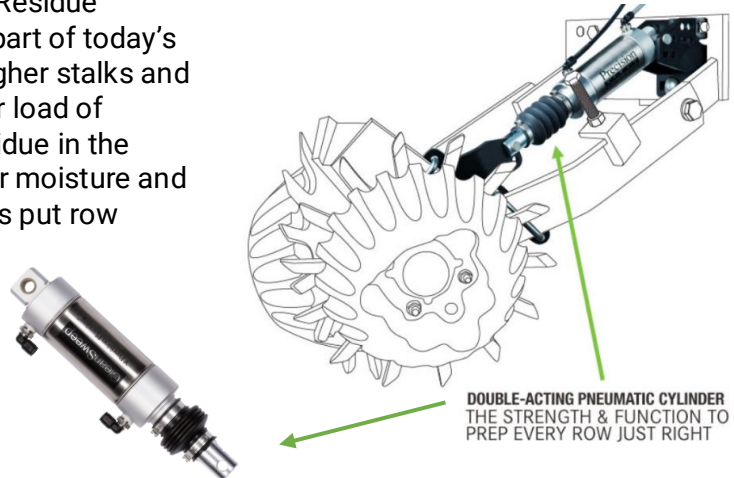


Planting Date: 5/25 Variety: GH 3582 Tillage: Strip-Till Population: 36K Row Width: 30" Rotation: CAC Soybean Price: \$11.98

CleanSweep® Residue Management Study

Objective: This study evaluates the benefits of planter row cleaners equipped with CleanSweep® cylinders. Residue management has become a necessary part of today's operation to maximize profitability. Tougher stalks and more corn-on-corn acres mean a heavier load of residue that needs to be controlled. Residue in the seed trench competes with seedlings for moisture and harbors disease. CleanSweep® cylinders put row cleaners right where they need to be, moving residue but not the soil. Continuous adjustments can be made as field conditions change with the cab-mounted controller to easily lift or make more aggressive adjustments.

Figure 1. CleanSweep® System



In this study, we use air pressure to adjust CleanSweep® cylinder settings to allow the ability to change and evaluate the aggressiveness of row cleaners. These settings were then evaluated to study yield and economic advantages.

These agronomic settings consisted of:

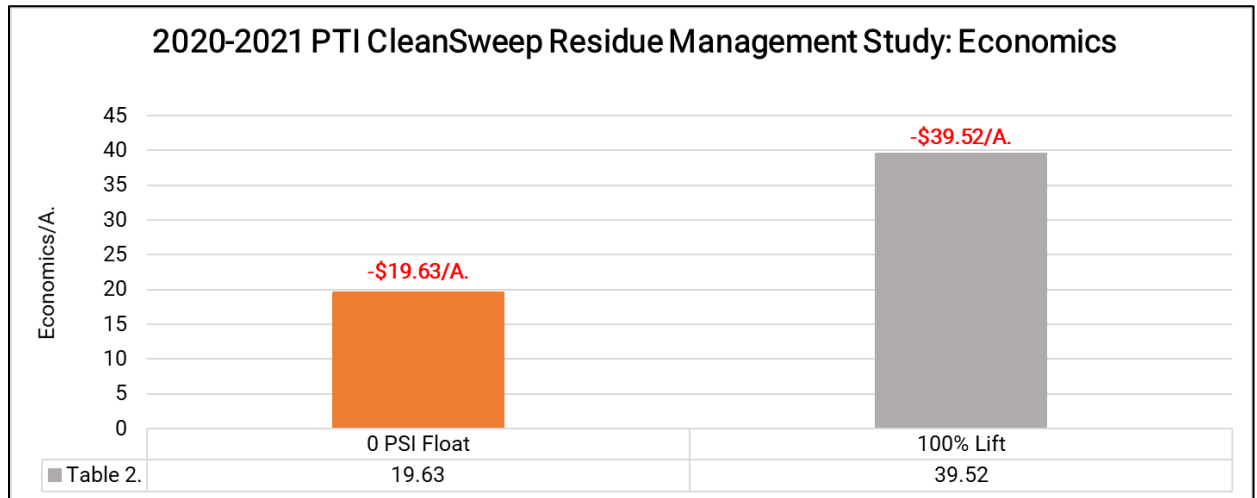
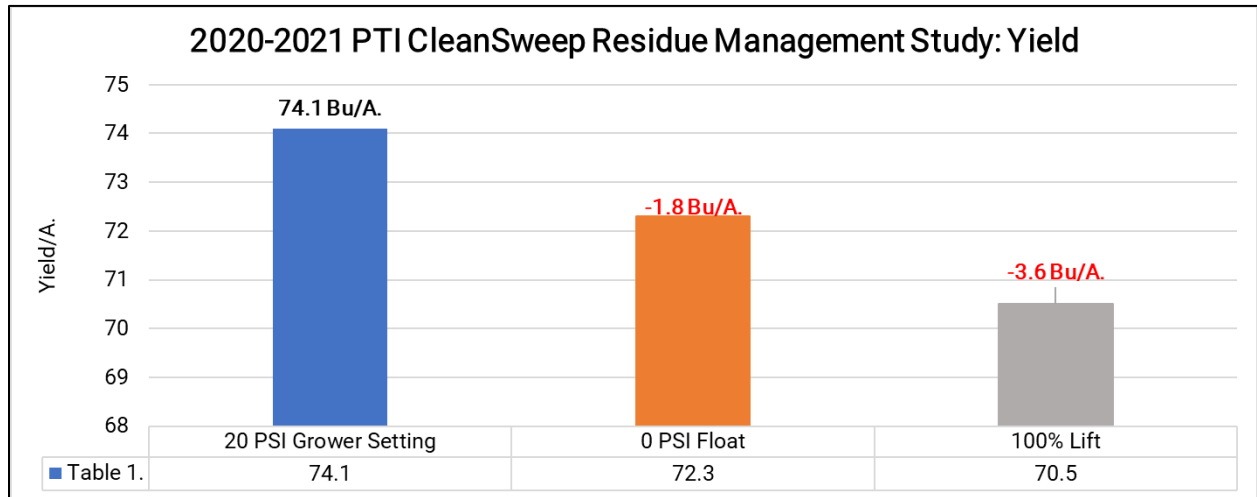
1. Lifting the row cleaners 100% to simulate the lack of row cleaners
2. A "floating" (0# psi) position that allows the row cleaner to ride along top of the soil surface with no air control, lift, or down-pressure.
3. 20# of air down-pressure, just aggressive enough to wipe crop residue and clods out of the way to lead a clean path ahead of the planter gauge wheels and seed disc openers.



CleanSweep® Residue Management Study Continued

Results: Table 1. illustrates CleanSweep® system yield results from the past 2 years at the PTI Farm. 100% lift (no row cleaners), resulted in yield losses of **-3.6 Bu/A.** and floating row cleaners proved losses of **-1.8 Bu/A.** compared to the 20psi down setting.

Table 2. summarizes the economics of having the correct residue manager setting. At \$11.98 soybeans, 100% lift resulted in losses of **-\$39.52/A.** while floating **-\$19.63/A.**



DownForce Management Study

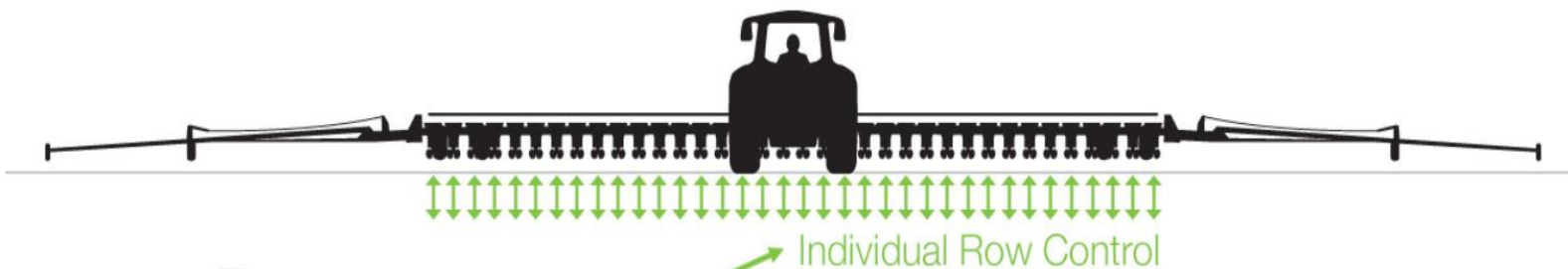
Objective: This soybean study evaluates yield impact of implementing proper downforce compared to too light or too heavy row unit settings. Planter row unit downforce is a common agronomic issue that often goes unaddressed. When downforce matches field conditions, the depth of planting is consistent and correct. Too light of row unit downforce causes planting depth to shallow up, potentially placing seed in dry soil, creating poorly rooted plants that struggle for water and nutrients. Conversely, too much downforce can lead to furrow side-wall compaction, also creating an environment that can cause limited plant access to water and nutrients.

DeltaForce® system replaces the springs or air bags on your planter with hydraulic cylinders (Figure 1). It automatically increases or decreases weight with military precision, on each row individually. When one row encounters conditions different than another (wheel tracks, old roadbeds, clay knobs, headlands, etc.), each will adjust independently (Figure 2). Row by row, foot by foot, even seed by seed an environment that fosters uniform germination, optimum growth and maximum yield can be produced.

Figure 1. DeltaForce® Cylinder



Figure 2.

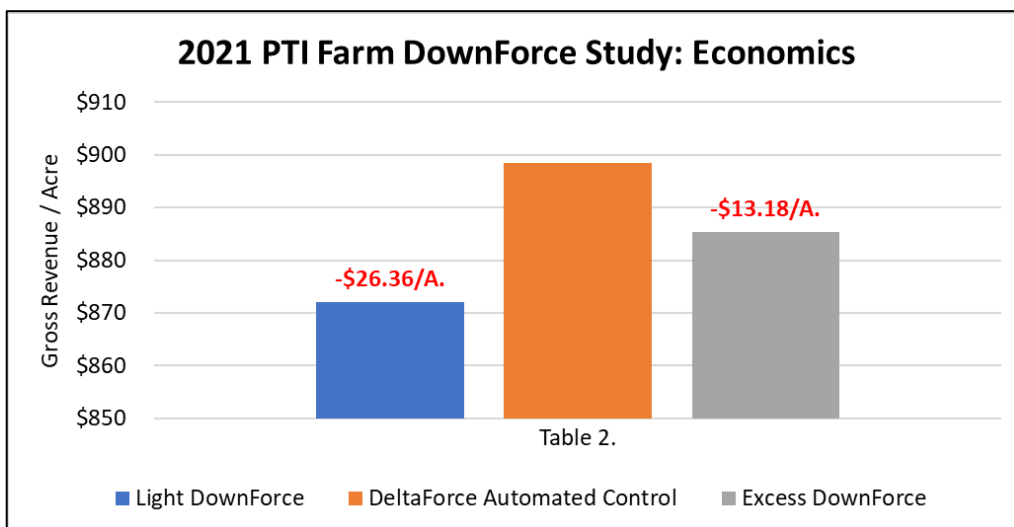
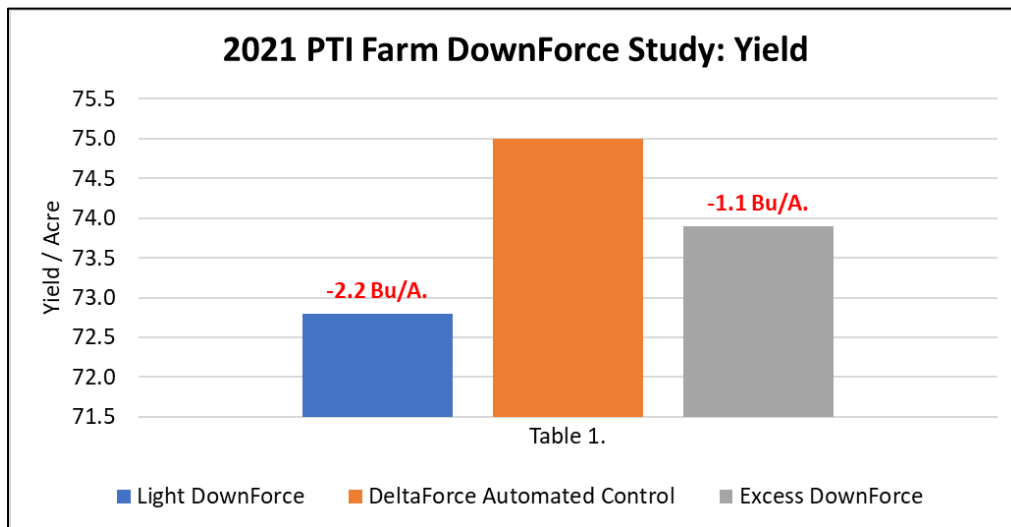


DownForce Management Study Continued

Results: Tables 1-2. illustrates the yield and economic response of DeltaForce® automated control compared to excessive and light downforce settings. Settings for this study include;

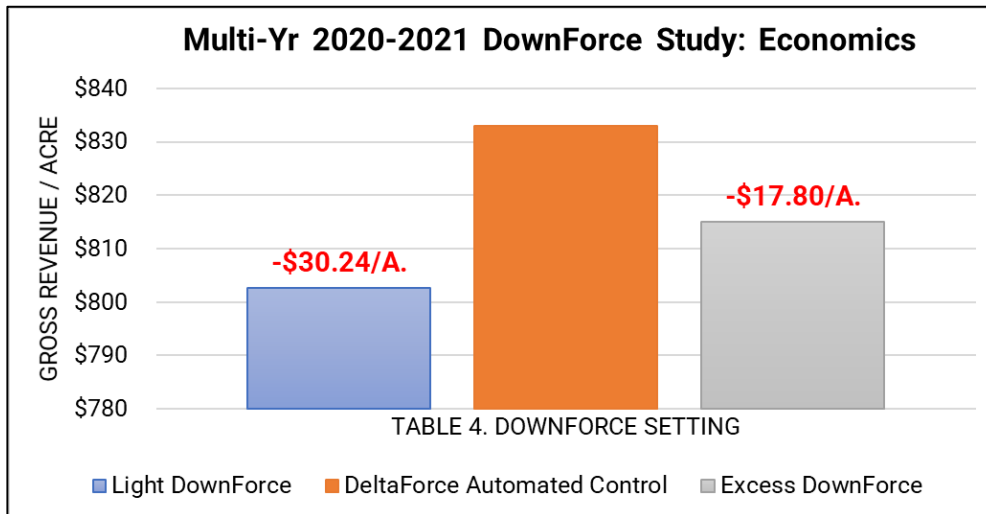
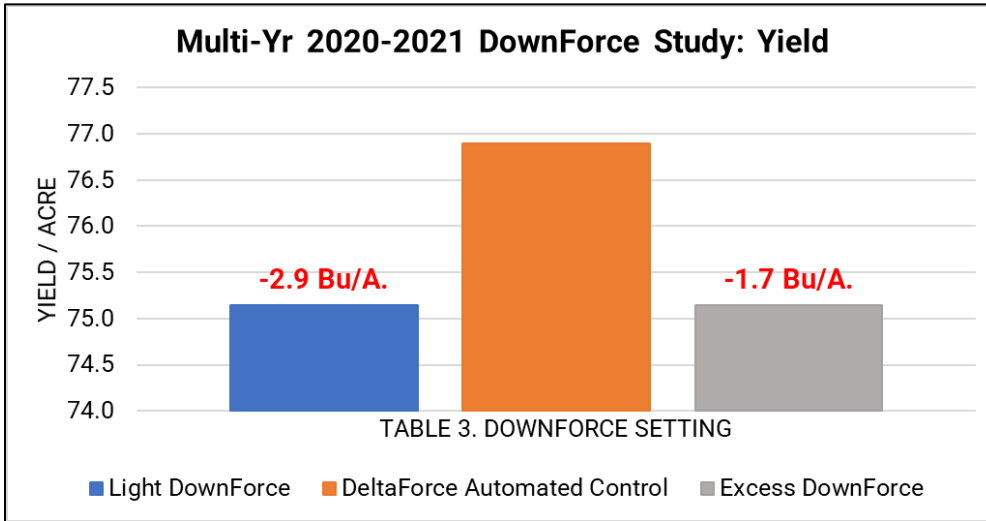
- Too light of Downforce (175# lift, 100# down)
- Proper Downforce (Automated Custom 90#)
- Excess Downforce (550# down, 100# up)

2021 data resulted with light downforce realizing yield losses of **-2.2 Bu/A.**, with corresponding net economic losses of **-\$26.36/A.** Heavy downforce caused yield losses of **-1.1 Bu/A.**, with economic losses of **-\$13.18/A.**



DownForce Management Study Continued

Tables 3-4. illustrate multiyear data which resulted in light downforce having yield losses of **-2.9 Bu/A.**, with corresponding net economic losses of **-\$30.24/A.** Heavy downforce caused yield losses of **-1.7 Bu/A.**, with economic losses of **-17.80/A.**



Planting Date: May 17

Variety: AG 27X1XF

Population: 130K

Row Width: 30"

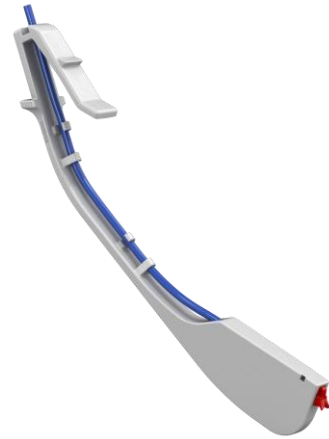
Rotation: BAC

Soybean Price: \$11.98

Keeton® Seed Firmer Study

Objective: This study evaluates the benefits of Keeton® Seed Firmers (Figure 1). Seeds don't always land right in the bottom of the trench where they belong. With its unique, in-the-trench design, the Keeton® Seed Firmer gently firms those seeds to the bottom of the V-trench (Figure 1). The end result is even depth, correct seed-to-soil contact, and most importantly uniform germination.

Figure 1. Keeton® Seed Firmer

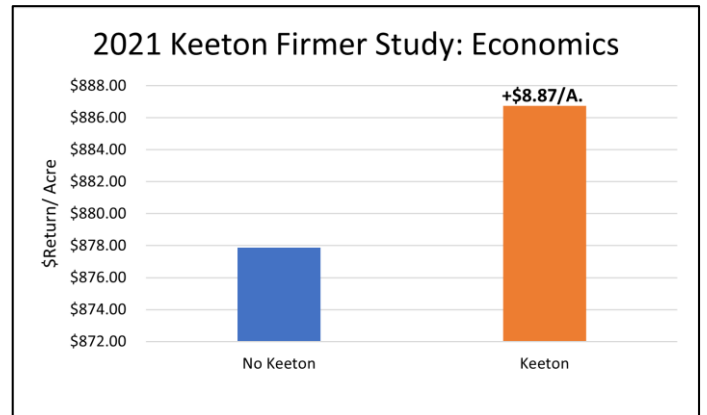
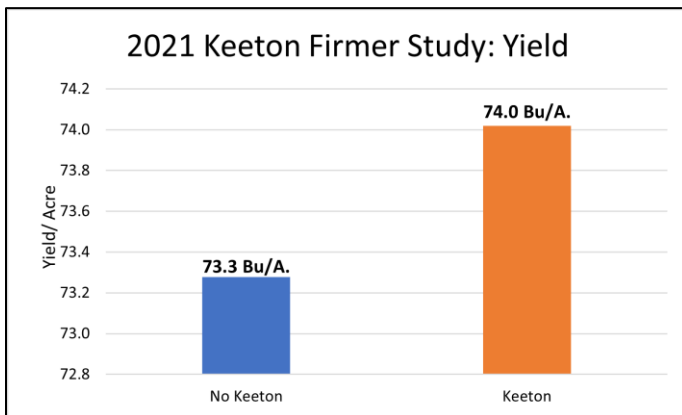


Results: Table 1. illustrates the presence of Keeton® Seed Firmers resulting in yield gains of +0.7 Bu/A.

Using \$11.98 soybeans, Keeton® Seed Firmers resulted in average economic gains of +\$8.87/A.

At a cost of \$35/row for Keeton® Seed Firmers and quick attach brackets for a 16-row planter, using the +\$8.87/A. increase in revenue, break-even occurs at 63 acres.

Figure 2. Good Seed to Soil Contact from Keeton®



FurrowJet® Side-Wall Study

Objective: FurrowJet® system is a planter fertilizer attachment (Figure 1.) that enables placement of not only an in-furrow starter fertilizer, but also a dual-band of fertilizer 3/4" on each side of the seed. To achieve this dual-band placement, the wings on FurrowJet® system angle downward to cut into the sidewall and place fertilizer alongside the seed in a dual-band. By doing this, lifting and fracturing can occur that potentially could remove soil smearing or compaction created by disc openers. Additionally, closing wheel systems following FurrowJet® wings have a better opportunity to close the seed trench, remove air pockets, and allow for good seed-to-soil contact.



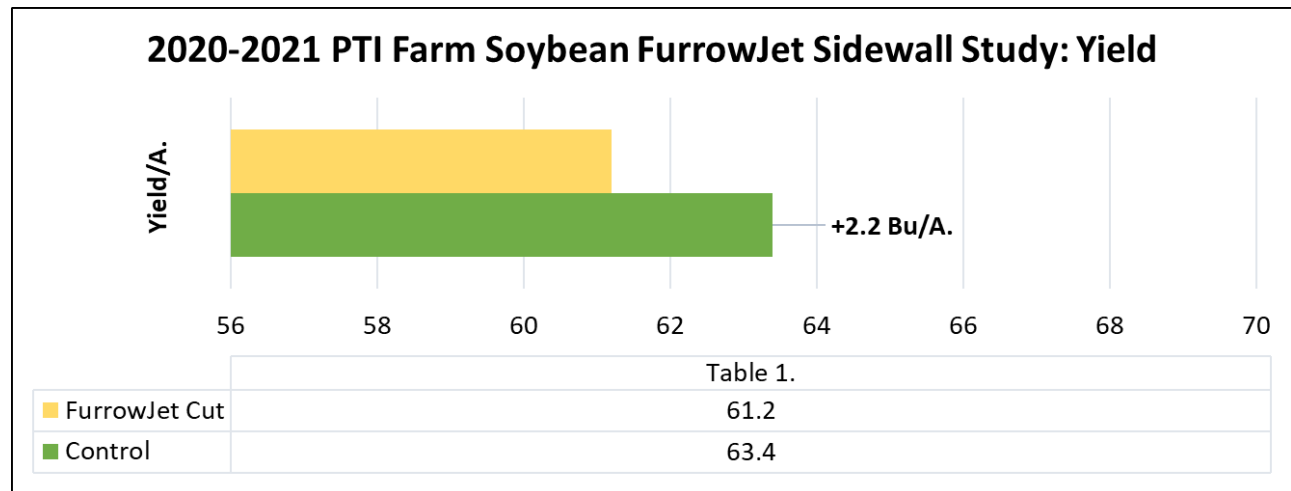
Figure 1. FurrowJet®

This study evaluates FurrowJet® dual-band wings offering the ability to cut, lift and remove side-wall compaction in the seed furrow (Figure 2). For this study, no liquid fertilizer was applied.

Figure 2: FurrowJet® Dual-Band Wings Fracturing Side-Walls



Results: This study has been implemented on corn at the PTI Farm for the last 3 years, however this is the 2nd year we have testing side-wall relief in soybeans. Table 1. illustrates FurrowJet® systems resulted in +2.2 Bu/A. yield gains compared to non-firmer/FurrowJet® system. At \$11.98 soybeans, these gains would reflect additional revenue of +\$26.35/A. At a cost of \$320/Row for FurrowJet® systems, break-even would occur on a 16-row planter, with this scenario at only 194 acres, not even considering any liquid fertilizer potential benefit.



Soybean Singulation Study

Objective: To evaluate the agronomic and economic advantage of singulating soybeans. In this study we compare the use of an 80-cell vs 56-cell soybean crop kit (Figure 1). Typical spacing of soybean plants achieved with singulation is illustrated in Figure 2.

Figure 1.

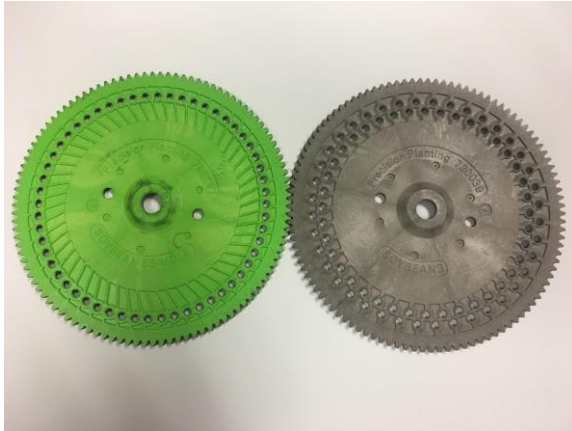
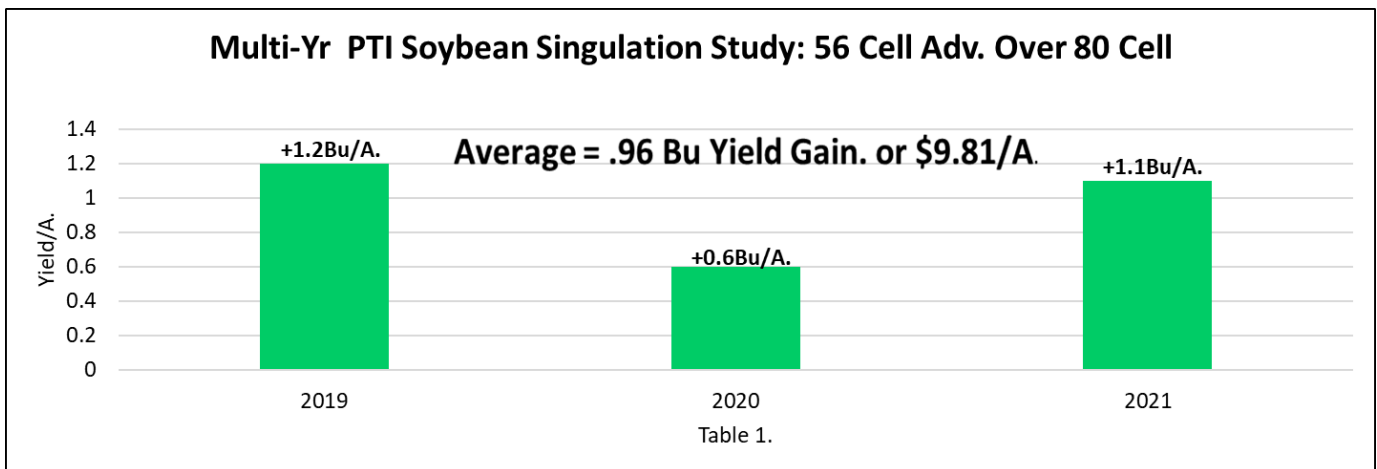


Figure 2.



Results: Table 1. summarizes the yields of both the 56-cell and 80-cell crop kits at seeding rates of 125K/A. in 30" rows. 56-cell crop kits resulted in +1.1 Bu/A. yield increases due to singulating soybeans. At \$11.98/Bu. soybeans, this equates to an economic advantage of +\$13.18/A. The multi-year data over 2019-2021 shows there was a +0.96 Bu/A. or \$9.81/A advantage over the gray 80 cell-disc. The cost of upgrading to the 56-cell disc and new ejector wheel is \$16 a row assuming you already have a singulator. When using multi-year economic data, on a 16-row planter it would take a grower 26 acres to break-even on this investment.



Soybean Tillage/Closing Wheel Study

Objective: To evaluate the performance of a single-stage non-sensing and two-stage automatic sensing closing systems in four different tillage practices including conventional, strip, vertical, and no-till.

Closing systems are designed to close the seed trench, eliminate sidewall compaction/smearing, remove air pockets, all at the same time achieving good seed-to-soil contact. This study evaluates the two distinctly different types of closing wheel systems including the following:



FurrowForce® Closing and Sensing/Control System:

Advantages:

- Lift and fractures sidewall compaction/smear
- 2nd stage stitching, removal of air pocket
- Automatic Sensing of soil variability
- Automatic Control to ensure proper settings

Disadvantages: Rocks can cause plugging



Dual Yetter Poly Twister™ Spike Closing System:

Advantages:

- Lifts and fractures sidewall compaction/smear
- Center Ring acts as depth maintainer

Disadvantages: Lightweight wheels require increased tension

- Manual T-Handle Control
- Spring Variability
- Non-Sensing to Soil Density Changes

Soybean Tillage/Closing Wheel Study Continued

Four tillage systems were evaluated in the study to evaluate the difference in closing performance.

Vertical-Till (Figure 1.) In the fall after harvest, vertical tillage was used to mix, cut, and level residue in a 3" depth tillage pass. Herbicide was used as a burndown to control early season weeds in the absence of spring tillage.

No-Till: (Figure 2.) Planting directly into last year's corn stalks with no tillage activity performed. Herbicide was used as a burndown to control early season weeds in the absence of tillage.

Conventional Till (Figure 3.) In the fall after harvest, deep 13" ripping with aggressive cutting and mixing of residue. A spring soil finisher leveled before planting.

Strip-Till (Figure 4.) In the fall after harvest, 10" deep strips were created with strip-till unit. Herbicide was used as a burndown to control early season weeds in the absence of spring tillage.

Figure 1. Sunflower® 6833 Vertical Tillage Tool



Figure 2. Planting in No-Till



Figure 3. Sunflower® 4630 Disc-Ripper

Figure 4. Kuhn® Krause Gladiator



Soybean Closing Wheel Study Continued

Results:

Vertical-Till: FurrowForce® in vertical-till environments proved positive yield gains of +2.4 Bu/A., with associated revenue gains of +\$28.75/A.

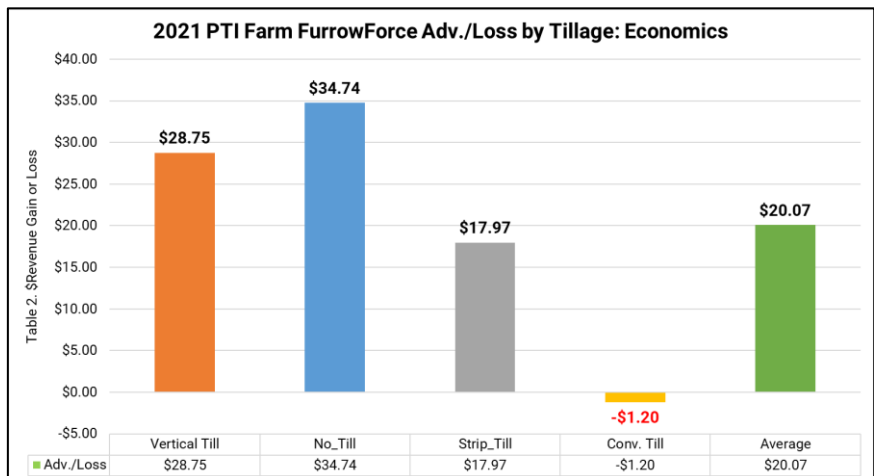
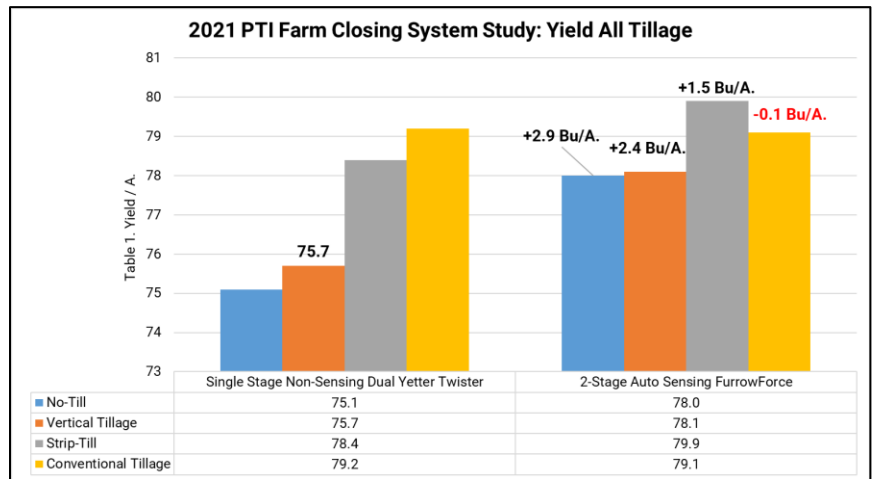
No-Till: FurrowForce® proved positive yield gains of +2.9 Bu/A., with revenue gains of +\$34.74/A.

Strip-Till: FurrowForce® proved positive yield gains of +1.5 Bu/A., with revenue gains of +\$17.97/A.

Conventional: Only 0.1 Bu/A. resulted between the two closing systems. Yetter Poly Twisters proved a positive yield gain of +0.1 Bu/A., resulting in a revenue gain of +\$1.20/A.

Overall, FurrowForce® closing resulted in average yield gains of +1.7 Bu/A. and additional revenue of +\$20.07/A. However, the clear advantage came in no-till and vertical tillage environments. In these reduced tillage programs, yield gains resulted in +2.4 to 2.9 Bu/A. with increased revenue of +\$28.75 to +\$34.74/A.

In summary, for years planters have struggled with closing systems with manual settings that offered the inability to account for and change for varying soil conditions. Today, we are excited that technology finally exists where farmers can use sensing technology on the planter row unit to determine how much force is needed on closing systems to address soil variability. By using a robust 2-stage closing system, load pin and sensing architecture, partnered with a 20|20® monitor, farmers can be confident of closing the seed trench, eliminating sidewall compaction/smearing, and removing air pockets all while planting through various seedbed conditions on a pass-pass basis.



Soybean FurrowForce® Automated vs Manual Control Study

Objective: This study evaluates the yield and economic effects of utilizing a FurrowForce® closing system in both manual and automated control settings in soybeans. FurrowForce® is a robust 2-stage closing system with load pins and a sensing architecture platform. When partnered with the 20|20® monitor, farmers can be confident of closing the seed trench, eliminating sidewall compaction/smearing, and removing air pockets, all while planting through various seedbed conditions on a pass-pass basis.

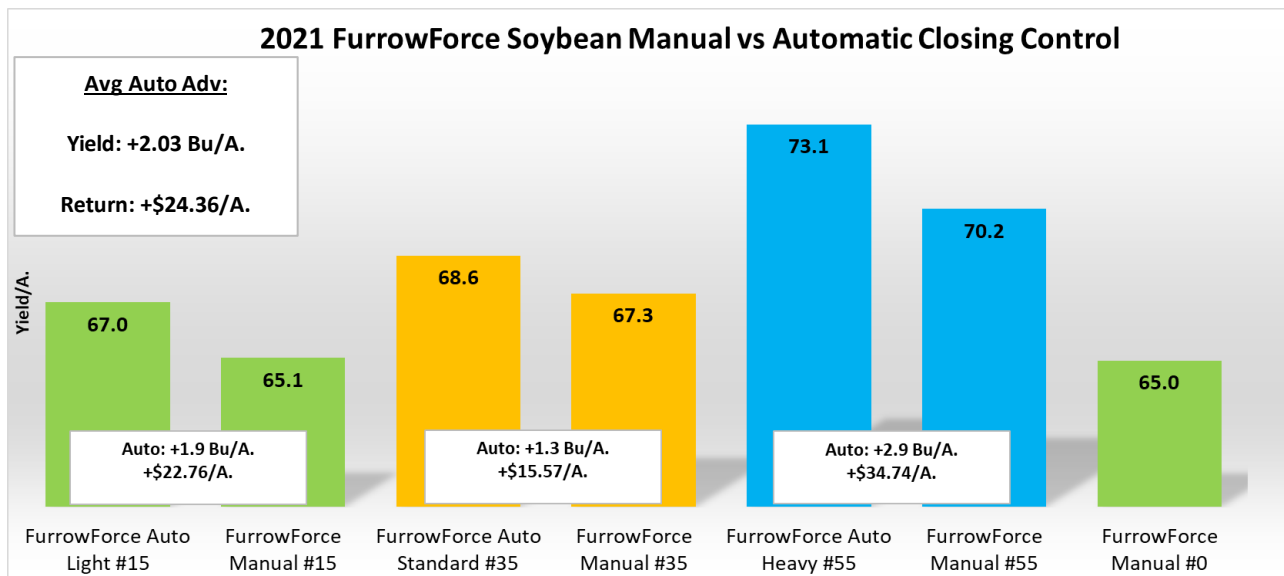


FurrowForce® was used in three automated and manual settings consisting of Light (15#), Standard (35#), and Heavy (55#) as set by the 20|20® system.



Results: Heavy closing pressure offered highest yields in both the manual and automatic setting. As closing pressure decreased, yield decreased.

The graph below illustrates automated control outperformed each manual setting with average yield gains of +2.03 Bu/A. These yield gains correlated to additional gross revenue of +\$24.36/A.



Planting Date: 4/17

Hybrid: GH 3192XF

Population: 130K

Row Width: 30"

Rotation: BAC

SB Price: \$11.98

2021 High Management Soybean Yield Study: West

Objective: This study evaluates the yield and economic impact of implementing an irrigated high yield management program in soybeans. Our goal was to learn how to implement high yielding programs and what it takes to drive soybean yield, knowing that we would have ample irrigation and drainage throughout the growing season from our on-farm reservoir and water recycling system (For more information please reference pages 41-45).

This high yield study evaluates the use of NETAFIM™ drip tape designed by NutraDrip Irrigation Systems and its ability to feed soybeans with water and nutrients for high yield potential. This method of irrigating a crop uses NETAFIM drip tape with small pressure regulating emitters evenly spaced at 24" apart (Figure 1). Drip tape in this study is not sub-surface irrigation, rather the team at PTI installed this system on the soil surface to demonstrate how the system works and to have mobility with irrigating trials at the PTI farm. Water is sourced from the PTI Farm water recycling reservoir and pumped out through a 3" line and FlexNet™ manifold system.



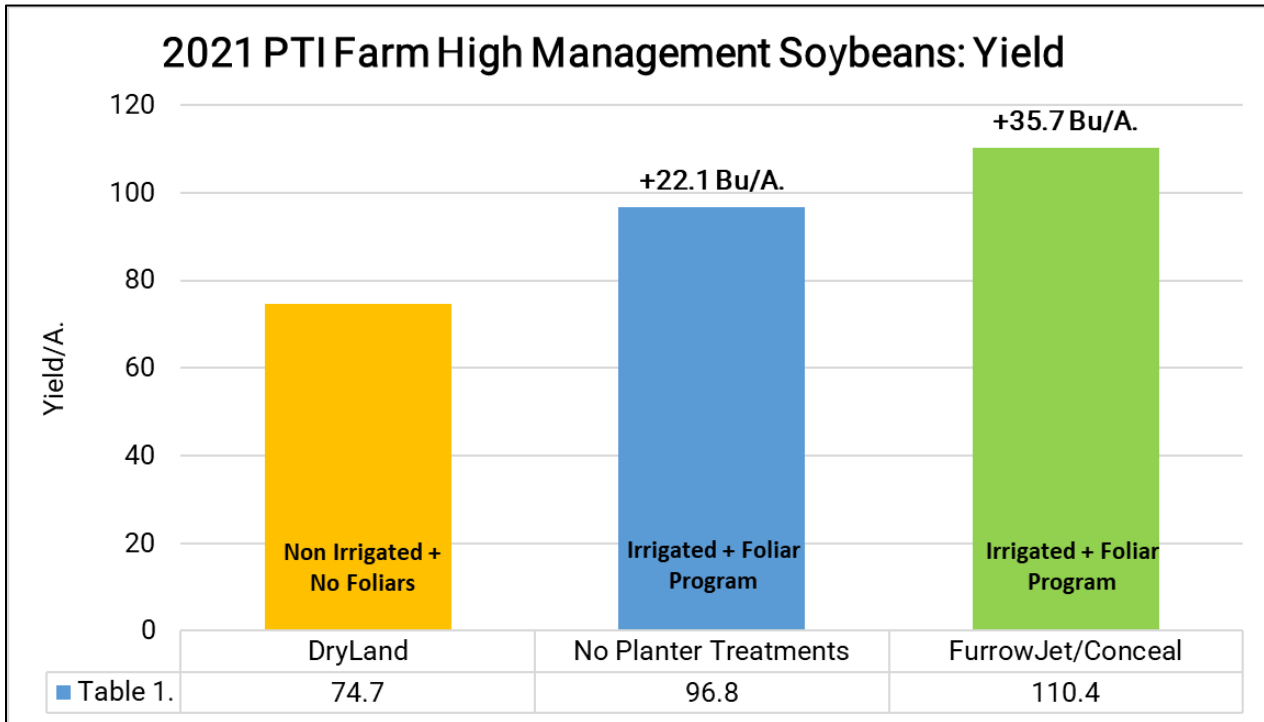
Figure 2. includes the individual treatments used in this study to try and achieve high yield, as well as the rates and placement of each product.

Figure 1. NetaFim® Drip Tape

Figure 2. 2021 Protocol

<p>FurrowJet® Center: At-Plant</p> <ul style="list-style-type: none"> • 1 Gal/A. QLF Boost • 8oz StollerUSA Bio-Forge® Adv. • 32oz StollerUSA Charge 	<p>FurrowJet® Wing: At-Plant</p> <ul style="list-style-type: none"> • 1.5 Gal/A. Nachurs TripleOption® • 1.5 Gal/A. Nachur's Balance® • 2 Gal/A. Water 	<p>Conceal®: At-Plant</p> <ul style="list-style-type: none"> • 5 Gal/A. 32% UAN • 3 Gal/A. Nachurs K-Fuse® • 10 Gal/A. Nachur's Throwback® • 32oz/A. Nachur's HumiFlexMAX® • 2Qt Nachur's SideSwipe®
<p>Foliar: 5th Trifoliolate</p> <ul style="list-style-type: none"> • 1Pt/A. Nachurs FinishLine • 2Qt/A. Nachurs TripleOption® • Applied with Herbicide 	<p>Foliar: R1</p> <ul style="list-style-type: none"> • 1 Gal/A. Nachur's K-Flex® • 3Qt/A. Nachur's imPulse® • 1Pt/A. Nachur's FinishLine® 	
<p>Foliar: R1</p> <ul style="list-style-type: none"> • Syngenta Miravis®Neo • 8oz Nachur's 10% Boron • 2oz Nachur's 10% Moly 	<p>Foliar: R3</p> <ul style="list-style-type: none"> • 15oz /A. BASF RevyTek™ • 1.5/A Gal Nachur's Balance® • 2Qt/A. Nachur's K-Fuel® 	<p>Foliar: R5</p> <ul style="list-style-type: none"> • Syngenta Miravis®Neo • 1Gal Nachurs Balance® • 2Qt Nachur's K-Fuel®

2021 PTI Farm High Management Soybean Yield Study: West



Results:

Table 1. illustrates the high yield of each soybean segment in our high management program. Soybean yields reached 110.4 Bu/A. by using irrigation, planter nutrition, and a sound foliar feed program. Irrigation and foliar feed programs accounted for +22.1 Bu/A. yield gains, while adding planter nutrition provided an additional +35.7 Bu/A. over the dryland control and +13.6 Bu/A. over the irrigated foliar treatments.



110.4 Bu/A.



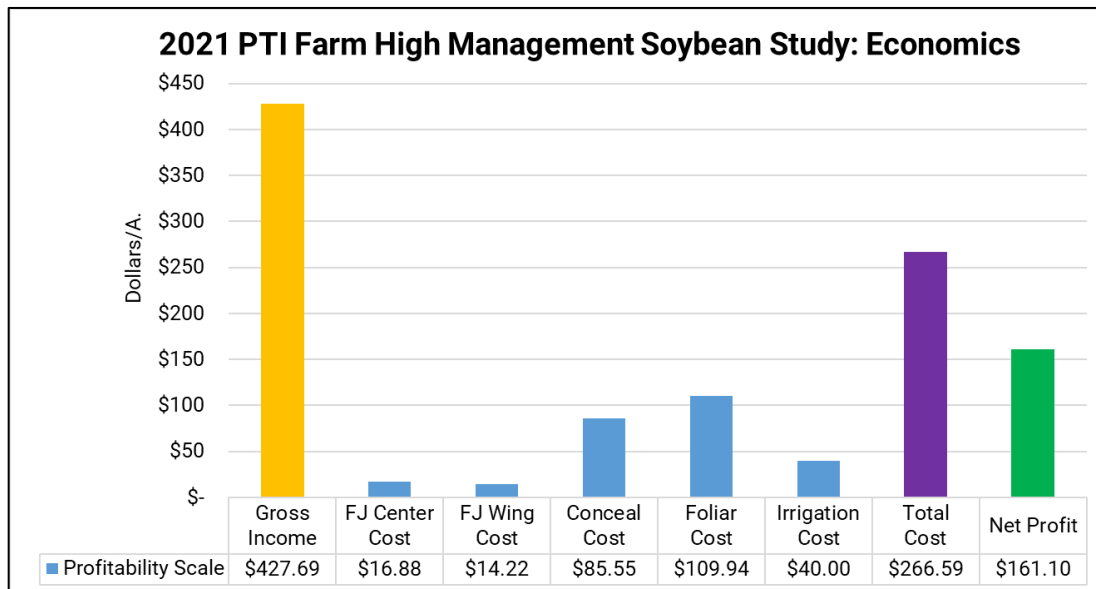
2021 PTI Farm High Management Soybean Yield Study: West

The table below summarizes profitability of the 2021 High Management Soybean Study. It is our belief that intensive management soybean trials that result in high yields, also need to be sustainable. PTI agronomic testing evaluates the overall initiative to increase yield potential, but it's imperative to evaluate the profitability of implementing programs that increase overall cost/A.

Sustainability:

PTI Farm Definition

- Action that promotes long term positive gain
- The capability of increasing yield consistently
- Ability to fund itself repeatably
- Doesn't endanger, environment, soils, or health

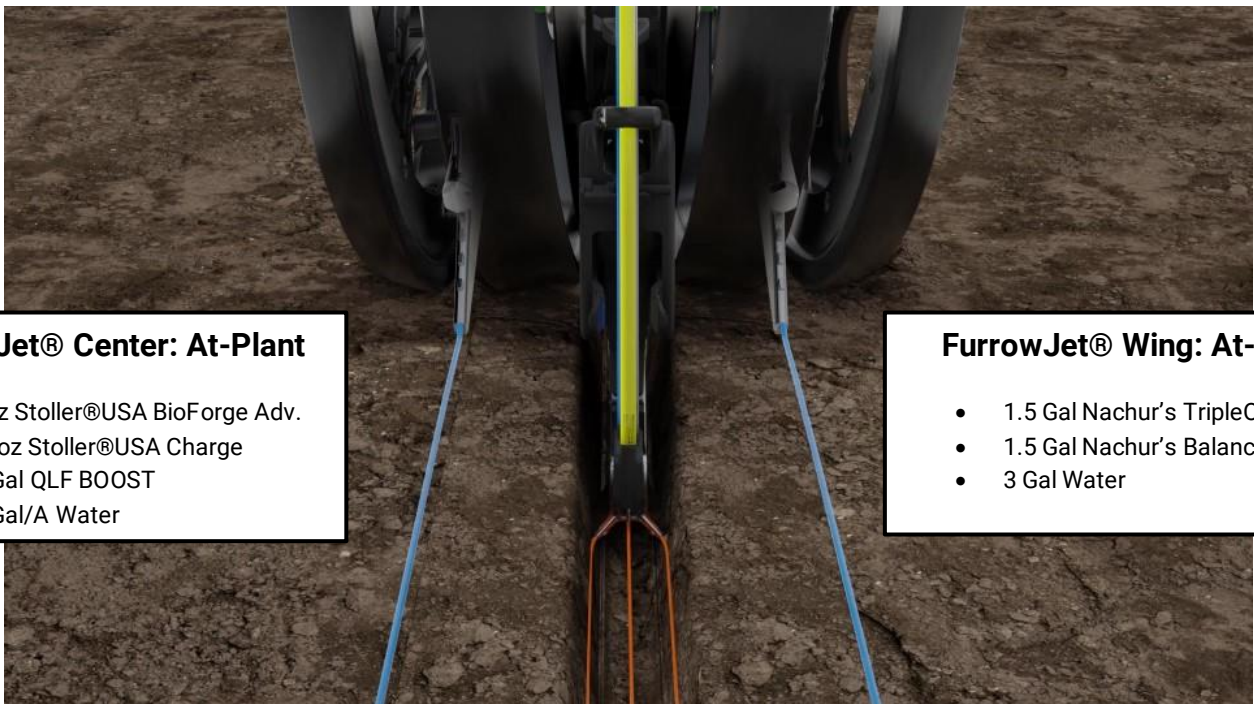


This year's high management soybean study reached yields of 110.4 Bu/A., an increase of over +37 Bu/A. over a traditional status quo program. However, the most important aspect to this study is sustainability. Even though crop inputs tallied an additional +\$266.59/A., a positive return on investment of +\$161.10/A. was realized. This will continue to be a focus as we evaluate high management programs at the PTI Farm.

High Management Soybean Planter Nutrition Study

Objective: In this high yield management trial, our goal was to learn how to implement high yielding programs and what it takes to drive corn yield using FurrowJet® and Conceal® at-plant fertilizer treatments. This high yield study utilizes the water management and recycling system at the PTI Farm and uses intensive tile drainage as well as NETAFIM NutraDip irrigation.

Three at-plant treatments, as well as a combination application are evaluated in this study and consists of the following crop nutrition products:



FurrowJet® Center: At-Plant

- 8oz Stoller®USA BioForge Adv.
- 32oz Stoller®USA Charge
- 1 Gal QLF BOOST
- 2 Gal/A Water

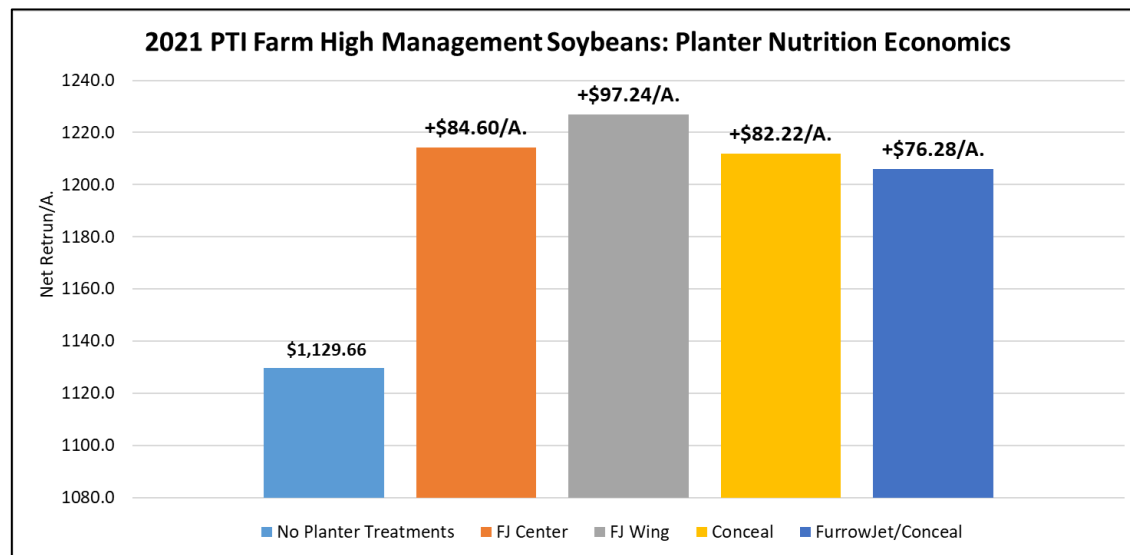
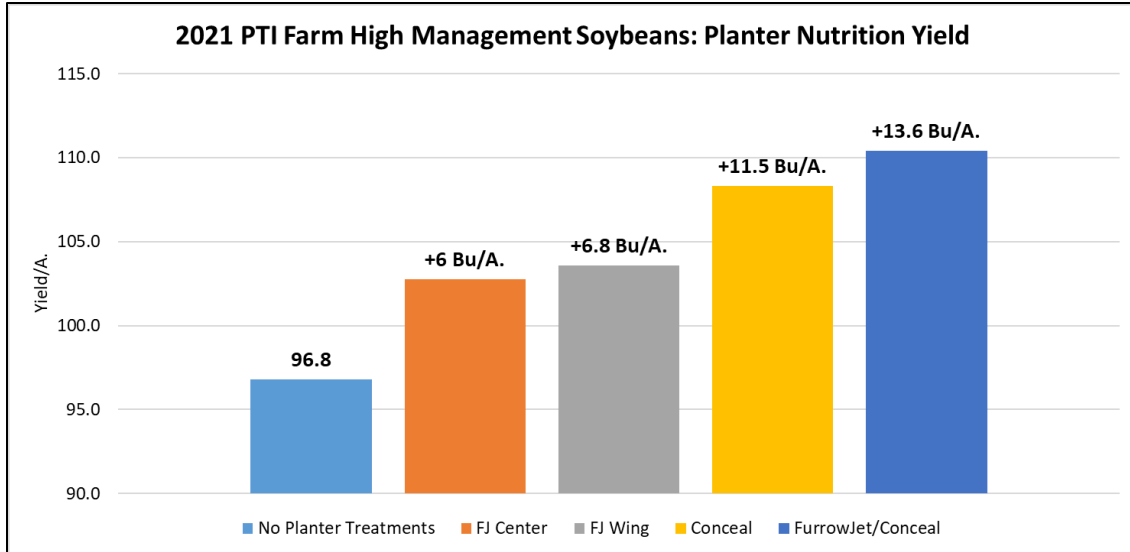
FurrowJet® Wing: At-Plant

- 1.5 Gal Nachur's TripleOption®
- 1.5 Gal Nachur's Balance®
- 3 Gal Water

Conceal® Dual Band: At-Plant

- 3 Gal/A. Nachurs K-Fuse®
- 10 Gal/A. Nachurs Throwback®
- 2 Qt/A. Nachurs SideSwipe®
- 1Qt Nachur's HumiFlexMax®
- 5 Gal/A. UAN 32%

High Management Soybean Planter Nutrition Study

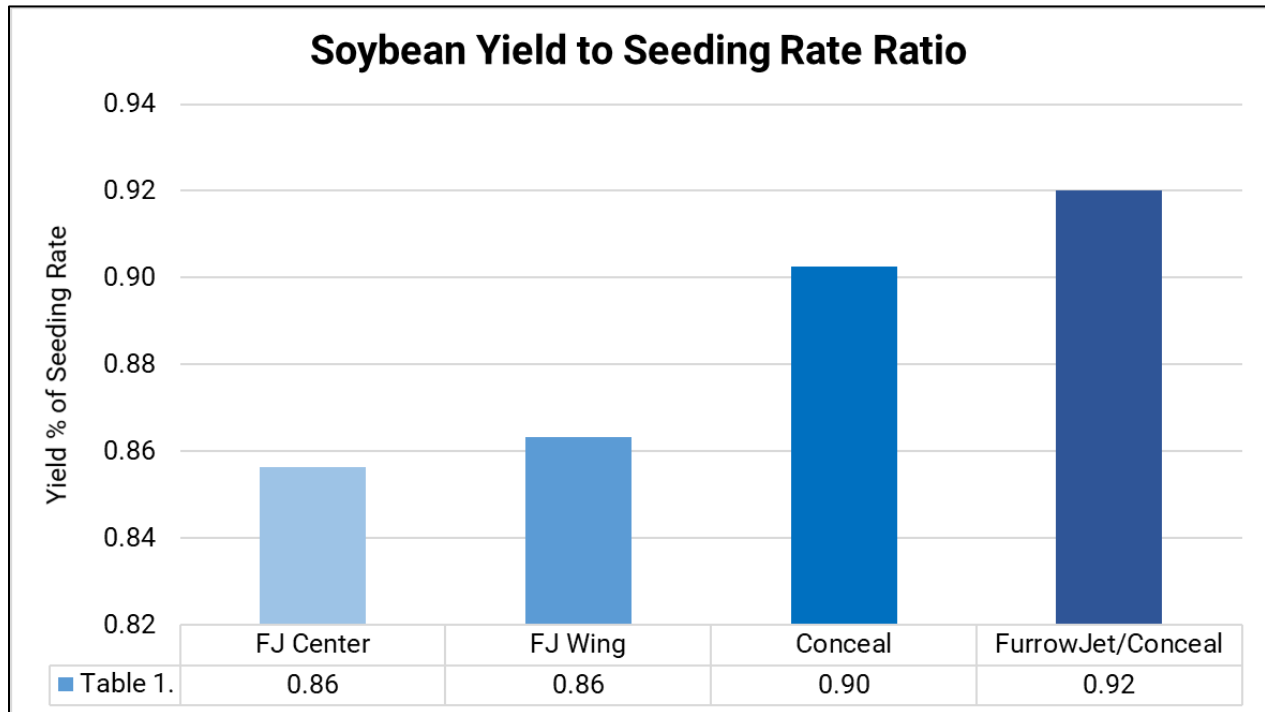


Results: Conceal® system treatments offered highest individual contribution to yield with +11.5 Bu/A. gains, while FurrowJet® center and wing treatments proved +6.8 and +6.0 Bu/A. gains. As for economics, FurrowJet® wing treatments resulted in highest economic returns with a ROI of +\$97.24/A. FurrowJet® center treatments tallied economics of +\$84.60/A. and Conceal® right behind at +\$82.22/A.

2021 High Management Soybeans: Yield to Seeding Rate Ratio

In an effort to understand soybean yield in relation to seeding rate, Table 1. illustrates actual yield divided by actual seeding rates. In other words, can soybean yield be equal to actual planted seeding rates?

For this study in 2021, soybean yield averaged 89% of seeding rate for all four nutrition segments with the combination treatment reaching the highest at 92%.



<u>Seeding Rate</u>	<u>SB Yield</u>	<u>Percentage</u>
120K	50 Bu/A.	42%
120K	60 Bu/A.	50%
120K	70 Bu/A.	58%
120K	80 Bu/A.	67%
120K	90 Bu/A.	75%

2021 High Management Soybean: NETAFIM™ Irrigation Study

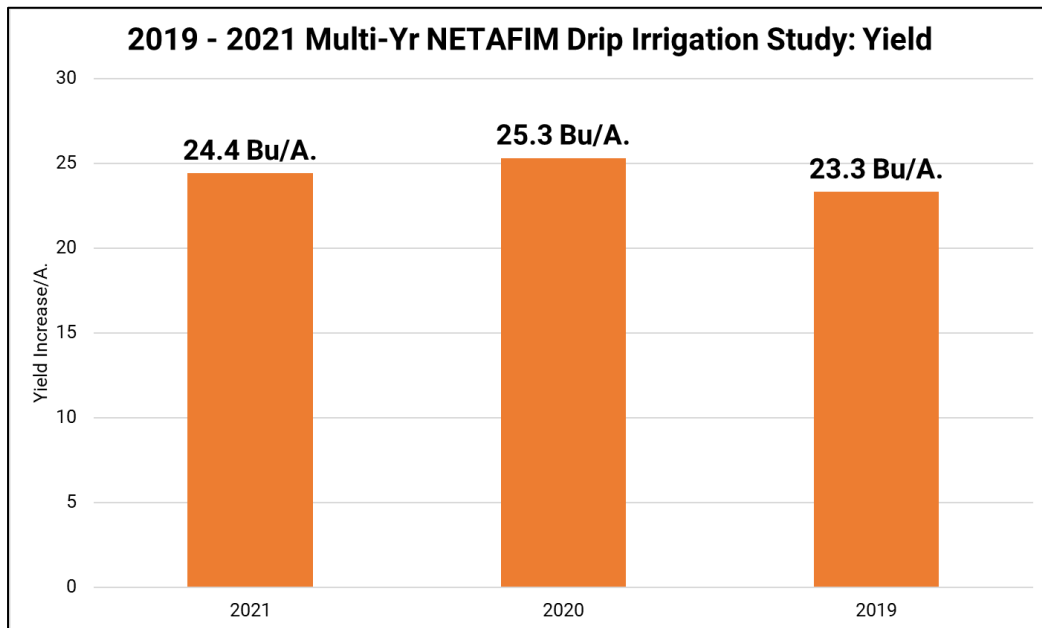
Objective: This study evaluates NETAFIM drip tape irrigation designed by NutraDrip Irrigation Systems and its' ability to feed soybeans with water and nutrients for high yield potential. This method of irrigating a crop uses NETAFIM drip tape with small pressure regulated emitters evenly spaced at 24" apart. Drip tape in this study is not sub-surface irrigation. It is rather installed on the soil surface to demonstrate how the system works, to growers who come to visit the PTI Farm. Water is accessed from a water recycling management program installed at the PTI Farm.



Results: In 2021, NETAFIM drip tape irrigation resulted in average soybean yields of over 110 Bu/A. with an average yield increases of +14.3 Bu/A. compared to dryland soybeans. 4.5" of water was applied through drip irrigation throughout the growing season from June - September. Fertigation was also implemented to apply Mn, Cu, B, S, N, P, and K.



Multi-Year data has proven irrigation to increase soybean yield by an average of 24.3 Bu/A., while increasing additional gross income by an average of +\$247.08/A.



2021 High Management Soybeans: Soybean Seed Size Study

Objective: To evaluate soybean seed size in relation to high yield soybeans.

In our 2021 high management soybean trials, our PTI Team quickly realized the soybean size was very large as a result of the various treatments applied throughout the growing season. Seed samples were collected at harvest and then ran through a series of seed counting and weighting exercises to determine actual seed weight and size (Figures 1-2).

Results: Table 1. summarizes the seed size differences of a high managed, irrigated protocol compared to that of a status quo, average management, dry land protocol.

Soybean seed sizes were 781 seeds/# larger in high management treatments and also exhibited higher test weight by 3.3 #'s/Bu. More work needs to be done to fully understand soybean seed size from various management techniques, but 2021 data suggests big beans equates to big yields.

Test weight is also a “unicorn” to understand, but overall grading standards in soybeans usually suggest average soybeans near 57#/Bu in most cases, even though farmers are graded at 60#/Bu.

Figure 1. Large Soybean Seed Size



Figure 2. Soybean Seed Counter



Table. 1

<u>Program:</u>	<u>Seed Size:</u>	<u>Test Weight:</u>
High Management:	2084 Seeds/#	60.4
Status Quo:	2865 Seeds/#	57.1

2021 High Management Soybean Study: East Farm Irrigated

Objective: This study focuses on yield and net return of soybeans placed in a high management environment with concentration placed upon at-plant nutrition in an irrigated protocol.

Figure 1. showcases planter nutrition placement of FurrowJet® (orange in-furrow) and dual band Conceal® system applications (blue).

Figure 1. At-Plant Nutrition Placement



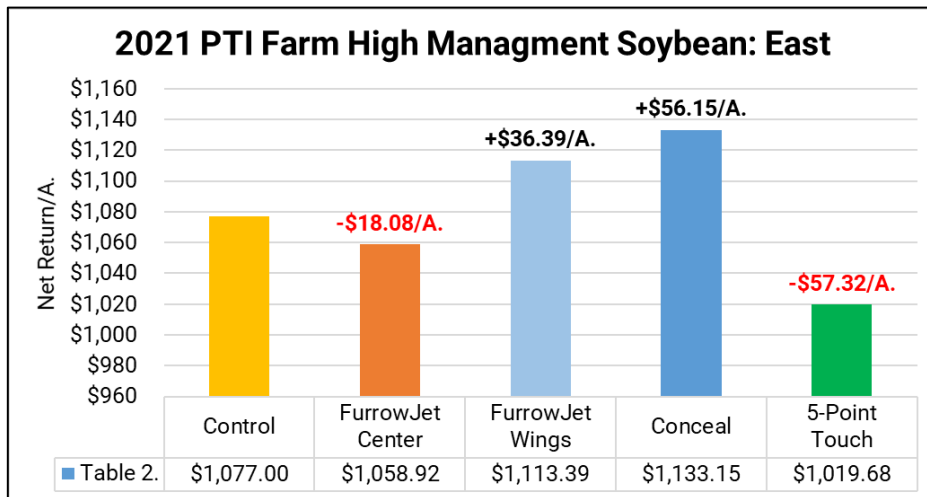
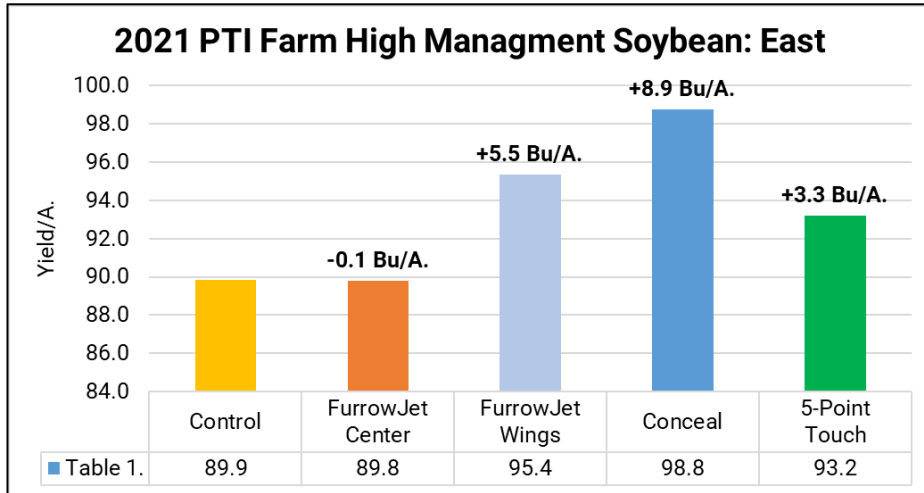
Figure 2. includes the protocol of all individual treatments used in this study to try and achieve high yield, as well as the rates and placement of each product.

A foliar program was also implemented as a means to compliment and drive high yield. However, foliars were used in all treatments in this study as base-line.

Figure 2. 2021 Protocol

<p>FurrowJet® Center: At-Plant</p> <ul style="list-style-type: none"> • 1 Gal/A. QLF 5-5-5-1S • 8oz StollerUSA Bio-Forge® Adv. • 32oz StollerUSA Charge 	<p>FurrowJet® Wing: At-Plant</p> <ul style="list-style-type: none"> • 6 gal Marco LTE • 1Qt Marco BioMarc • 2 Gal/A. Water 	<p>Conceal®: At-Plant</p> <ul style="list-style-type: none"> • 5 Gal/A. 32% UAN • 1 Gal QLF Boost • 15 Gal Marco BOOST • 1Qt Marco BioMarc • 1Qt Nachurs HumiFlex Max
<p>Foliar: 5th Trifoliolate</p> <ul style="list-style-type: none"> • 1Pt/A. Nachurs FinishLine • 2Qt/A. Nachurs TripleOption® • Applied with Herbicide 	<p>Foliar: R1</p> <ul style="list-style-type: none"> • 1 Gal/A. Nachur's K-Flex® • 3Qt/A. Nachur's imPulse® • 1Pt/A. Nachur's FinishLine® 	
<p>Foliar: R1</p> <ul style="list-style-type: none"> • Syngenta Miravis®Top • 8oz Nachur's 10% Boron • 2oz Nachur's 10% Moly 	<p>Foliar: R3</p> <ul style="list-style-type: none"> • 15oz /A. BASF RevyTek™ • 1.5/A Gal Nachur's Balance® • 2Qt/A. Nachur's K-Fuel® 	<p>Foliar: R5</p> <ul style="list-style-type: none"> • Syngenta Miravis®Neo • 1Gal Nachurs Balance® • 2Qt Nachur's K-Fuel®

2021 High Management Soybean Study: East Farm Irrigated



Results: FurrowJet® wing and Conceal® treatments resulted in yield gains of +5.5 to +8.9 Bu/A. with positive net returns of +\$36.39 to +\$56.15/A. respectively. However, individual FurrowJet® center treatments resulted in yield losses of -0.1 Bu/A. with economic losses of **-\$18.08/A.** due to tankmix partnering issues that slowed emergence and cause stand losses of 50%.

Calcium Products 98G™ Pell Lime Study:



Objective: This trial evaluates the yield response and economics of pelletized limestone (98G) applied fall broadcast. Soil pH is the foundation of nutrient availability and critical to maximizing crop yield. The availability of all nutrients is impacted by soil pH levels, especially phosphorus (P).

When soil pH is below 6.0, it can reduce your yield by as much as 30%. Calcium Products' 98G pelletized limestone is the most effective and consistent product to correct and maintain soil pH.

Change Soil pH Quickly

98G corrects soil pH faster and more completely than aglime. It is the most reactive liming material because it's made from 98% pure calcitic limestone and ground to an ultra-fine powder before it is pelletized. 98G pellets are engineered and manufactured to a specific size and hardness so that the pellets handle well and spread uniformly, yet break down in the field to change soil pH. 98G is fully reactive at about three to six months after application.

Maintain Soil pH to Consistently Maximize Yield

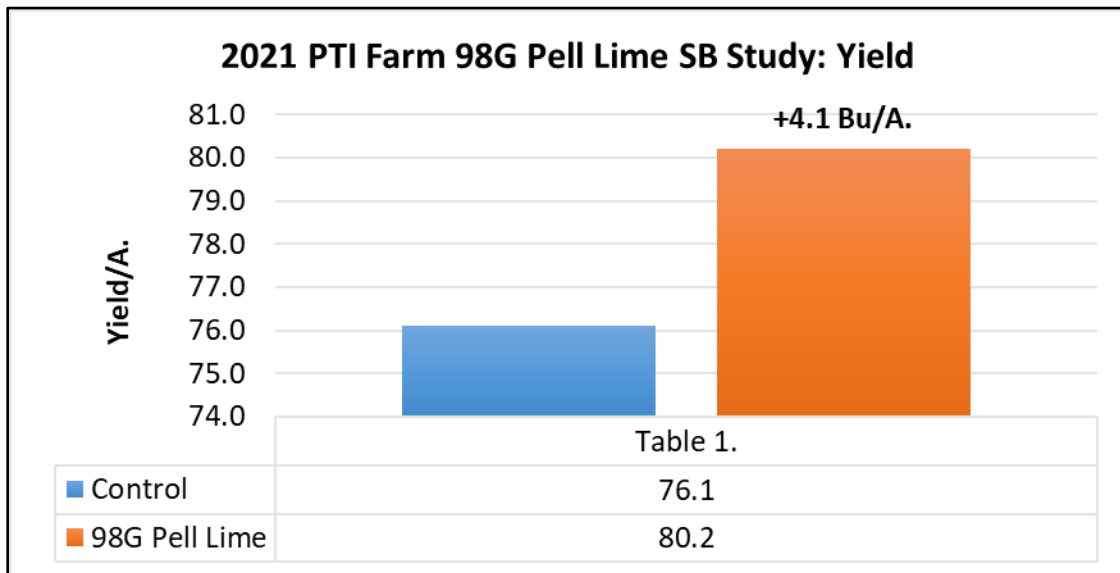
Once soil pH is restored, use 98G to maintain pH levels with more frequent, lower rate applications. Leaving yield on the table is unacceptable, and maintaining proper soil pH is a critical piece of good fertility management and maximizing yield.

Enjoy Application Flexibility

98G can be applied in flat-rate or variable-rate applications. It can be mixed with other dry fertilizers reducing the number of trips across the field and spread spring or fall. This flexibility means you can address soil pH when and how it works for you with the same equipment used to spread other dry fertilizers.

Soil pH has traditionally been addressed about every four years with aglime. Rather than create a pH "rollercoaster" in the field with infrequent aglime applications, 98G can be used as part of a pH maintenance program with annual or biannual applications. 98G is a more reactive liming material than aglime, keeping soil pH at a level to maximize yield potential (typically 6.0) year after year.

Results: 180# Fall 2020 broadcast treatments of 98G resulted in yield gains of +4.1 Bu/A. (Table 1.), and economic gains of +\$27.82/A. Soil tests were pulled in Fall 2020 and indicated soil pH at 6.2. Previous soil test results (Fall 17') indicated pH levels of 6.0 in this trial location.



Planting Date: 5/11

Variety: GH 3192XF

Population: 130K

Row Width: 30"

Rotation: BAC

Soybean Price: \$11.98

Pell Lime: \$192/Ton + \$4/A Application

Soybean Frost Study

Objective: To evaluate the agronomics and economics of re-planting soybeans due to frost injury. The 1st week of April offered some very warm (70-83°) and dry weather that allowed for a large amount of early planted soybeans. Due to the trend of more early planted soybeans to increase yield, the PTI Farm took this opportunity to learn about the risks of early planted soybeans, specifically frost damage.

Soybeans planted during the April 6-7th timeframe, incurred frost damage from frost/freezing temperatures during what we affectionately called the “Mother’s Day Massacre”. Mother’s Day weekend offered 27° low temperatures that wreaked havoc on soybean stands.

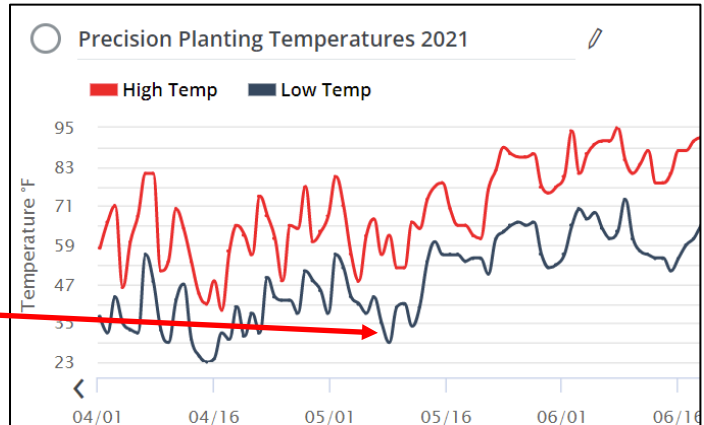


Figure 1. Mother’s Day Massacre Frost



Soybean Frost Study Continued

Results: Tillage played a major role in how much frost damage was incurred, as thermal radiation from black soils was crucial to help minimize stand losses. Exposed black soils were an excellent source of thermal radiation that can act as a barrier to frost, as soils stay warmer from daytime heating and offers protection during cold night-time low temperatures.

In general, the more tillage, the less frost that happened on Mother's Day weekend. Heavier tillage such as conventional tillage resulted in less frost, while reduced tillage such as vertical-till, strip-till, and no-till sustained significant frost damage and yield loss.

Conventional Tillage:

A disc ripper in the fall followed by one pass soil finisher in spring before planting set the stage for black soils which warmed up nicely during daylight hours.

Resulted in minimal damage and average stands of 132K.



Strip-Till:

Wide Fall strip-till bands provided good daytime thermal warming from black soil over top of the strip. If planted row deviated from center of strip and closer to residue, large stand losses occurred.

Resulted in moderate damage and average stands of 66K.



No-Till:

Minimal thermal warming due to lack of black soil. Scattered mat of corn residue resulted in cooler soils which led to higher frost occurrence with significant stand losses.

Resulted in substantial damage and average stands of 0 - 36K.



Soybean Frost Study Continued

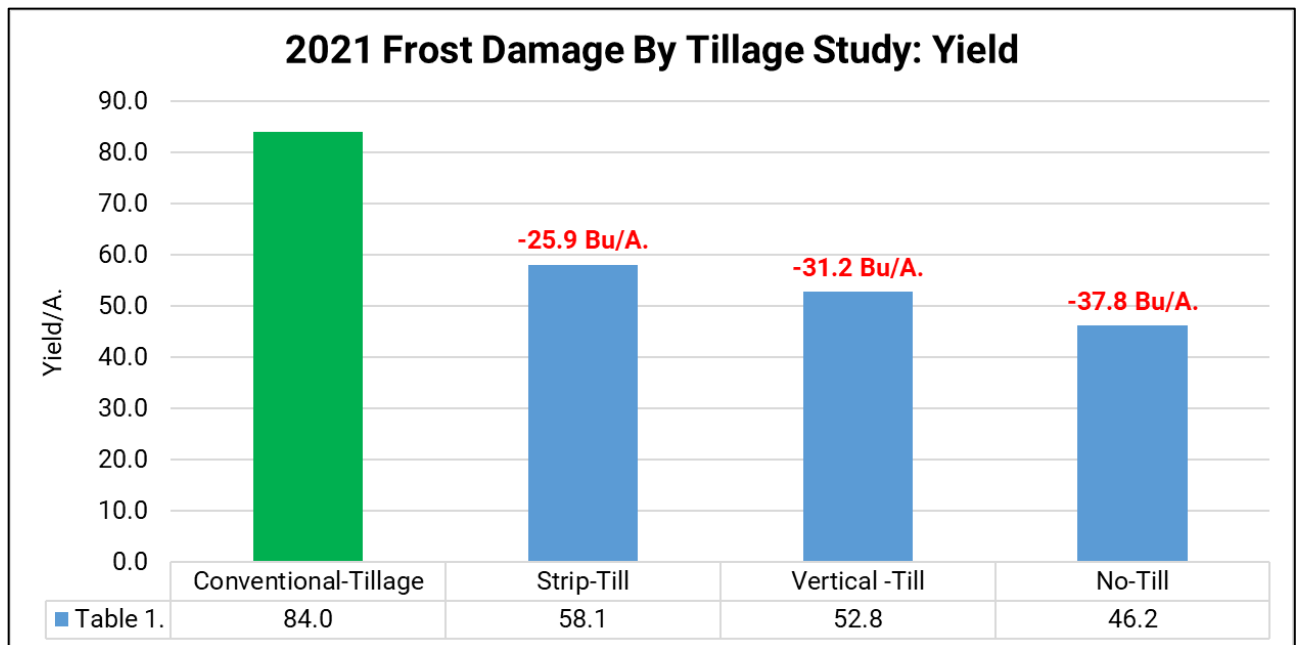
Vertical-Till:

Minimal thermal warming due to lack of black soil. Scattered mat of corn residue mixed into soil resulted in cooler soils, higher frost occurrence and significant stand losses.

Resulted in substantial damage and average stands of 0 - 49K.



Table 1. illustrates average soybean yield by tillage program. Conventional tillage achieved highest yield at 84 Bu/A., while all reduced tillage programs resulted in lower yields of 46.2 to 58.1 Bu/A. respectively. While these yields may seem somewhat reasonable overall average yields given the situation, they actually sustained significant losses of **-25.9 Bu/A.** to **-37.8 Bu/A.** compared to that of the conventional tillage soybeans with no frost injury. No-till and vertical tillage programs sustained the highest overall yield losses.



Planting Date: 4/6, 5/17

Variety: GH3582Enlist

Population: 130K

Row Width: 30"

Rotation: BAC

SB Price: \$11.98

Seed: \$60/Bag

Post Herbicide: \$15/A.

Re-Planting: \$17/A.

Soybean Frost Study Continued

To replant or not to replant? That was the emotional question this spring once we confirmed frost significantly reduced stands. In order to evaluate the yield and economic impact of replanting soybeans, each tillage program was split into individual sections to measure both the consequences of not replanting, as well as replanting the crop. It should be noted that soybeans in the conventional tillage program did not need replanting, due to lower frost injury as stated earlier.

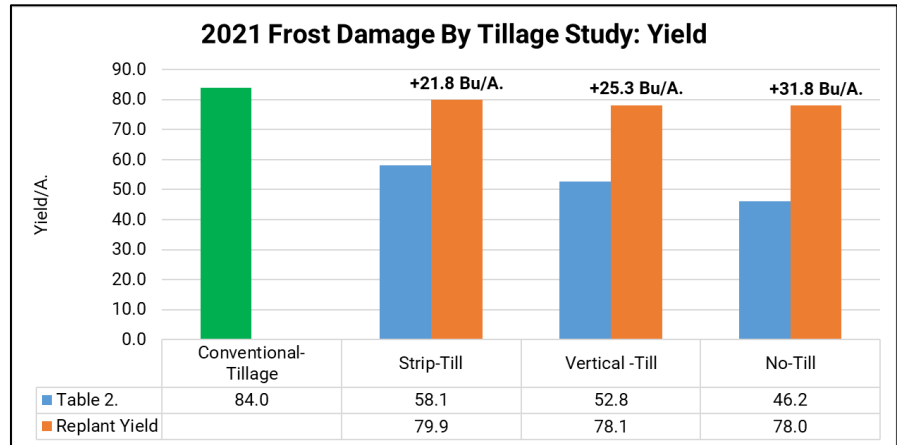
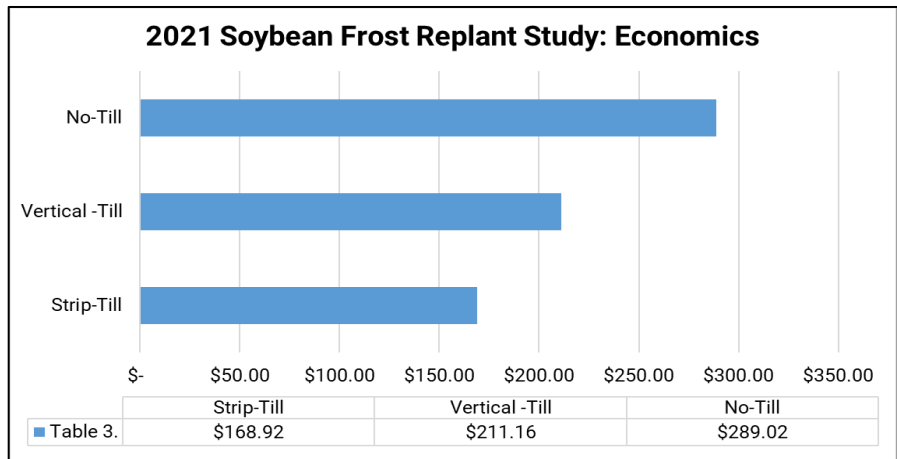


Table 2. illustrates the results of re-planting soybeans. Compared to original frost damaged yields of 46.2 to 58.1 Bu/A., replanting resulted in yield gains of +21.8 to +31.8 Bu/A. Overall, replant yields fell short of original conventional tillage yields by **-4.1**, **-5.9**, and **-6.0 Bu/A.** respectively.

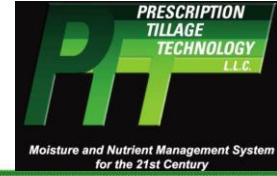


As with any replant scenario, there is a cost. In this case, it is replant soybean seed, planting the field a second time and a post herbicide being Enlist™ to control any volunteer soybeans. Table 3. illustrates the positive net return of replanting ranging from +\$168.92 to +\$289.02/A.

As with any replant, the decision is always emotional. In our case the decision was a bit easier, due to original early plant date (April 6th) eliminating late replant, and significant stand losses down to zero population. With the trend of early planting soybeans, more frost injury is bound to occur. In this case it paid to replant, but a grower needs to scout diligently and understand recovery rates of frost injury and ultimately final stand and its yield potential. Consider how thermal warming could occur in your situation. More aggressive row cleaners, wider strips, or more tillage could be helpful to offset early season frost injury.

STP Opening Disc Study

Objective: This study evaluates the use of 3 different types of opening discs from Prescription Tillage Technology L.L.C.



STV STANDARD TRUE V

Standard True "V" Blade with Anti-Stubbing or Dulling Technology

- Shallow and full planting depth
- Sharp gravel and shale rock conditions
- Standard soils and planting conditions
- Standard and offset true-V planter configurations
- Available with off-set blade configurations on standard planters
- Fits John Deere, Kinze, Harvest International, Horsch, Monosem, White and Precision



STP SABRE TOOTH PLANTER

True "V" & Single Blade Applications

- 1" minimum to full planting depth
- Challenging soil and planting conditions
- Challenging residue conditions
- Standard planter configurations
- Enhances early and late root development
- 14.75" inside with 15" outside combination fits John Deere, Kinze, Harvest International, Horsch, Monosem and older White
- 15.75" inside with 16" outside combination fits newer White and Precision



STPS SABRE TOOTH PLANTER SHALLOW FILLET

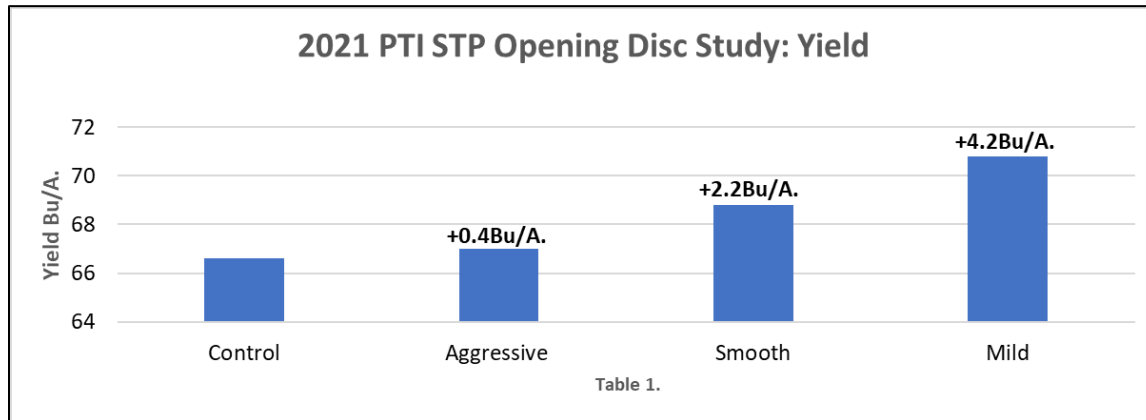
Shallow Planting Sharp Gravel & Shale Rock Conditions

- Shallow and full planting depth for cotton, canola, and shallow seed placement requirements
- Sharp gravel and rock conditions
- Challenging soils and planting conditions
- Enhances early and late root development
- .100 cut out
- 15" inside with 15" outside combination fits John Deere, Kinze, Harvest International, Horsch, Monosem and older White
- 16" inside with 16" outside combination fits newer White and Precision



STP Opening Disc Study Continued

Results: Table 1. illustrates each of the Prescription Tillage Technology’s opening discs performance compared to the control. STP (aggressive) openers saw a +0.4Bu/A. advantage over the control, which resulted in a gain of +\$4.79/A. STV (smooth) openers realized gains of +2.2Bu/A. which led to economic return of +\$26.36/A. Finally, STPS (mild) discs resulted in +4.2Bu/A increases. This yield increase saw a \$50.32/A. return.



STP disc installed on Harvest International planter



“U” Furrow created by STP



True “V” created by standard opener discs

Soybean Strip Planting Study

Objective: This study evaluates the yield and economic advantages of planting corn and soybeans in alternate 40' and 20' strips. The PTI team first evaluated this system in 2020 to harvest more sunlight on outside rows with the intention of trying to stimulate higher corn yield. It is quite common to have higher corn yield on the outside field edges, due to corn being able to harvest more sunlight. However, most often after the first few rows this yield advantage decreases due to more shading of corn biomass.

However, to increase corn yield with this strip cropping system, it seems as if soybeans are used as a “sacrificial lamb” to help

introduce a sunlight corridor to help increase corn yield. As a result, corn rows end up competing and shading soybean rows at various times of the morning and evening hours (Figure 2.). This study is intended to measure the associated economics from this system.

In order to understand the agronomics of this strip cropping system, we split our trial design into four segments:

- 40' Soybean Blocks (16 rows) planted in North/South rows
- 40' Soybean Blocks (16 rows) planted in East/West rows
- 20' Soybean Blocks (8 rows) planted in North/South rows
- 20' Soybean Blocks (8 rows) planted in East/West rows

Figure 1. 40' Alternate Strips of Corn and Soybeans



Soybean Strip Planting Study Continued

Figure 3. 40' (16row) Alternate Strip Planting of Soybeans

Figure 3 illustrates the soybean strips in a 40' or 16 row 30" block formation. These soybean blocks were planted alternatively with 30" corn in both a North to South and East to West planting row to allow the ability to study the differences in sunlight shading. In corn, we also implemented the use of "shorter" stature corn being planted on the outside 4 rows of each 40' or 16 row block in an attempt to minimize shading of the soybeans from the corn.



Figure 4 illustrates soybean strip planting in a 20' or 8 row 30" block formation. These soybeans were also planted alternatively with 30" corn in both a North to South, as well as an East to West planted row to allow the ability to study the differences in sunlight shading and overall yield differences between wide and narrower soybean blocks. Both "shorter" stature corn and a tall hybrid were implemented in the 20' blocks, but only independently and not within the same block.

Figure 4. 20' (8row) Alternate Strips of Soybeans

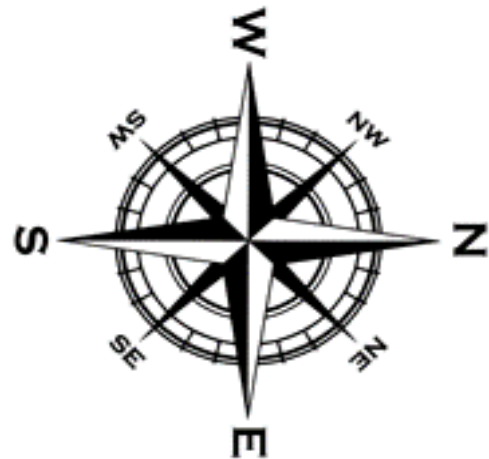
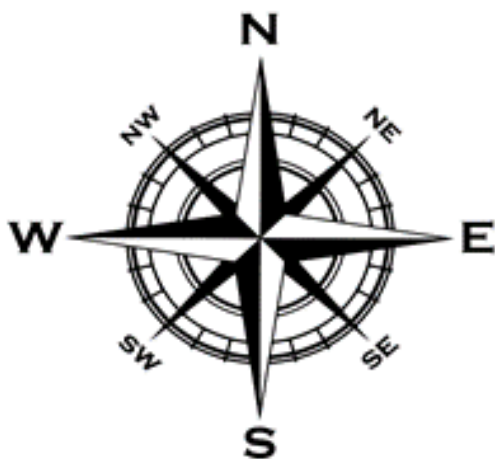


Soybean Strip Planting Study Continued

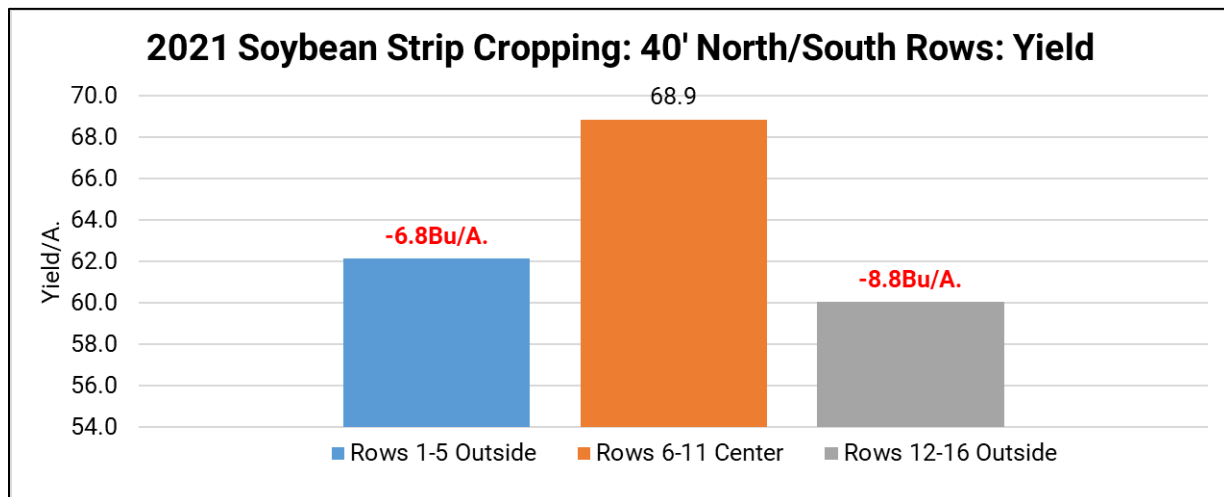
In order to understand the agronomics of the 40' or 16 row blocks, we split our 16-row planter into three individual segments to evaluate soybean yield performance:



These three individual segments were then planted in both North to South and East to West directional planting formations to evaluate the yield and economics on planter row direction.



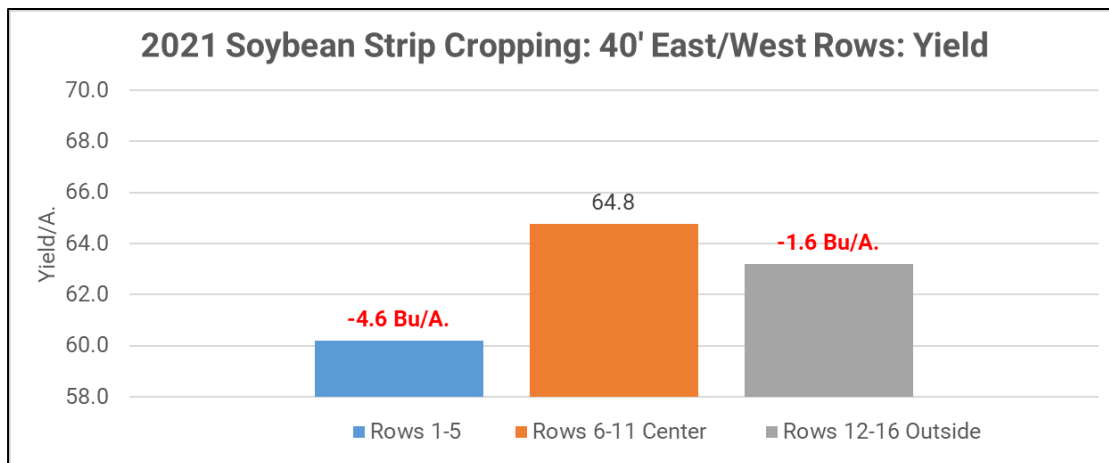
Soybean Strip Planting Study Continued



The above graph illustrates the yield response of each planter row segment in the 40' alternate strips planted in a North/South formation. Compared to the center six planter rows, the outside five rows of the planter rows 1-5 and 12-16 offered average yield losses of **-6.8 Bu/A. to -8.8 Bu/A.** Status quo full field planting would equate to 68.9 Bu/A. soybean yield (center 6 rows), while this crop stripping experiment decreased soybean yield to 60.1 Bu/A. and 62.1 Bu/A. on the inside "solar corridor" rows next to the corn.

Overall, north/south row strips planted in 40' (16 row) blocks offered **average** yield losses of **-7.8 Bu/A.** resulting in revenue losses of **-\$93.44/A.**

Soybean Strip Planting Study Continued



The above graph illustrates the yield response of each planter row segment in the 40' alternate strips planted in an East/West formation. Compared to the center six planter rows, the outside five rows of the planter (rows 1-5 and 12-16) offered average yield losses of **-1.6 Bu/A. to -4.6 Bu/A.** Status quo full field planting would equate to 64.8 Bu/A. soybean yield (center 6 rows), while this crop stripping experiment decreased soybean yield to 60.2 Bu/A. to 63.2 Bu/A. on the inside "solar corridor" rows next to the corn.

Overall, east/west row strips planted in 40' (16 row) blocks offered **average** yield losses of **-3.1 Bu/A.** resulting in revenue losses of **-\$37.14/A.,** a +\$56.30 improvement compared to north/south rows. This potentially being the difference in less overall sunlight shading in an east/west planting formation compared to north/south.

Soybean Strip Planting Study Continued

To understand corn yield in strips by block size, 20' (8 row) blocks were planted with a four-row planter. This smaller configuration allows for more "solar corridor" outside rows and reduces the 40' blocks to half the size. Due the small size of the 20' strips, yield data was only harvested as a single strip.

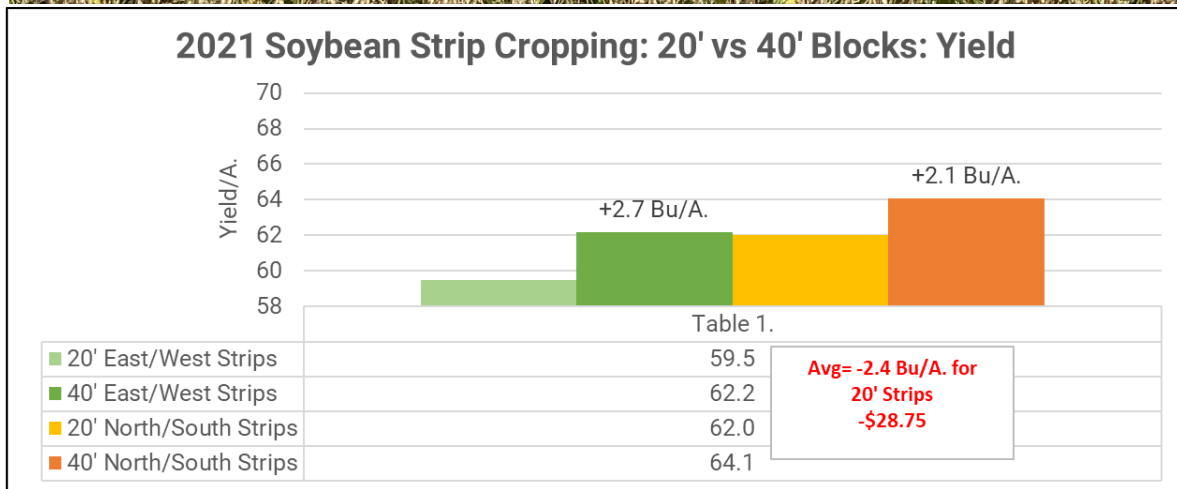


Table 1. illustrates average yield of both soybean block sizes. 20' soybean blocks resulted in average overall yield losses of **-2.4 Bu/A.** and reduced revenue of **-\$28.75/A.** compared to that of 40' stripped blocks.

Soybean Strip Planting Study Continued

Table 2. illustrates the net losses of strip cropping soybeans compared to status quo traditional non-strip cropping. 20' soybeans in strips resulted in net losses of **-\$82.66/A.** in north/south strips and **-\$63.49/A.** in east/west strips. This \$19.17/A. reduction in losses may be associated with east/west rows having less sunlight shading than that of north/south rows.

40' soybeans in strips resulted in net losses of **-\$57.50/A.** in north/south strips and **-\$31.15/A.** in east/west strips. This \$26.35/A. reduction in losses once again may be result of associated less sunlight shading than that of north/south rows. Figure 2. is an example of sunlight shading from outside corn strips.

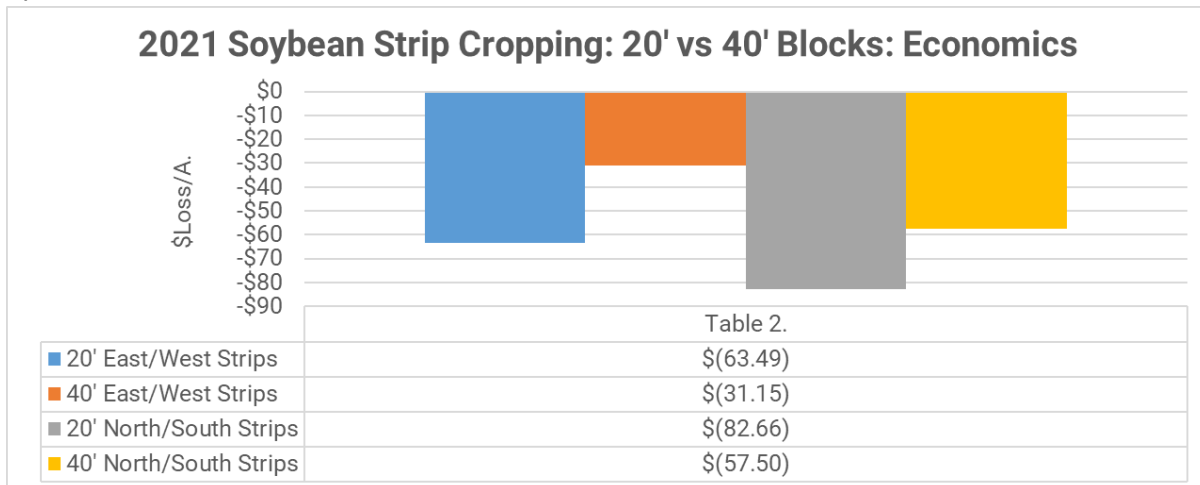


Figure 2. Late Afternoon Corn Shading Effect

Strip Crop Planting Summary

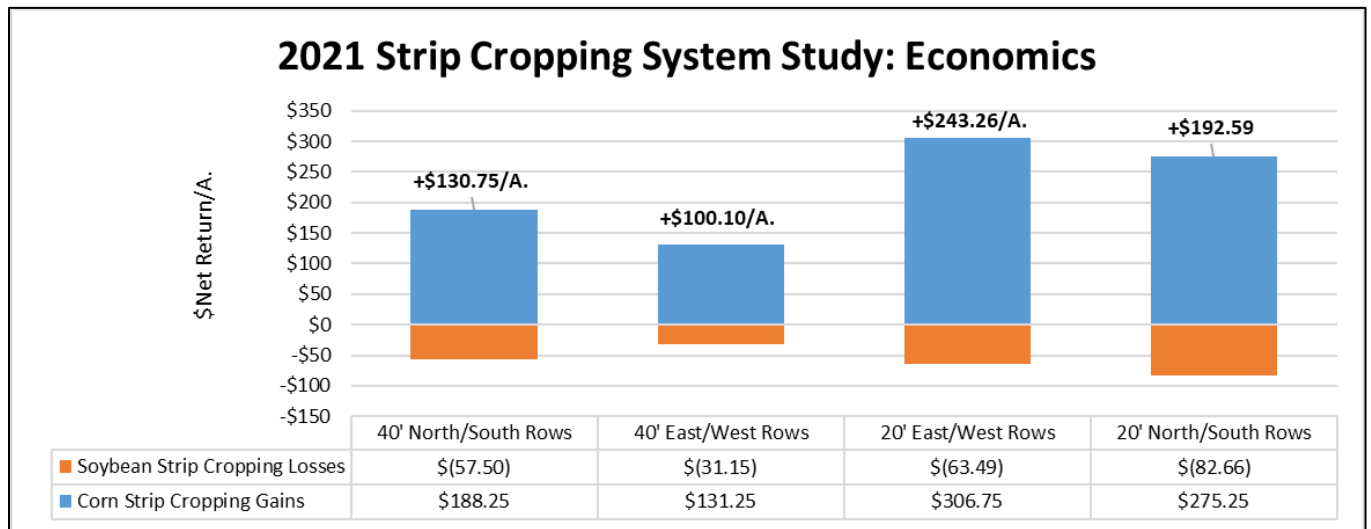
Objective: This summary evaluates the overall economic advantages of planting corn and soybeans in alternate 40' and 20' strips. Individual results by crop are available on pages 134-141 and 198-204.

The graph below illustrates the overall economic gains and losses from the strip cropping system at the PTI Farm in 2021. Strip cropping corn clearly resulted in monumental yield gains in outside sunlight corridor rows. Both 300 bushel corn yields and revenue gains of over \$300/A. were realized from this cropping system! Smaller 20' corn blocks realized both highest yields and revenue, compared to 40' blocks.



However, soybeans are a true sacrificial lamb in this cropping system. Soybeans in a strip cropping system incurred net yield and revenue loss in every block size and planting direction. Net revenue losses were realized from **-\$31.15/A.** to **-\$82.66/A.** with the smaller 20' blocks resulting in the highest losses compared to wider 40' strips.

Even though soybeans resulted in large yield and revenue losses, it wasn't enough to negate the gains from corn. Even though soybeans lost money, it set the stage and allowed corn to flourish in strips. As a result, the overall strip cropping system resulted in net revenue gains of +\$100.10 to +\$243.26/A. The profitability of this system championed some of the highest overall revenue gains at the PTI Farm in 2021. Strip cropping does require higher attention to detail in regard to herbicide application and equipment size restrictions, however the system was profitable and challenges the status quo on corn and soybeans are currently grown.



Planting Date: 4/19

Variety: AgriGold 2909XF

Population: 130K

Row Width: 30"

Rotation: BAC

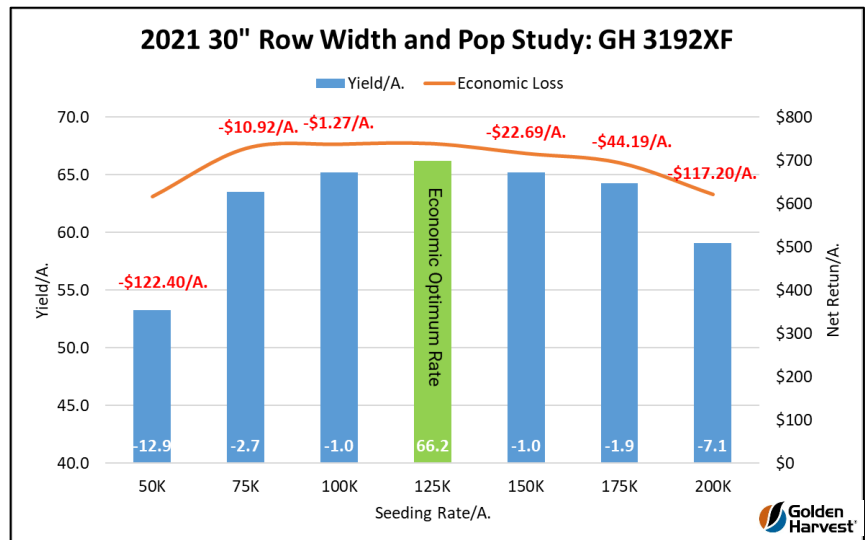
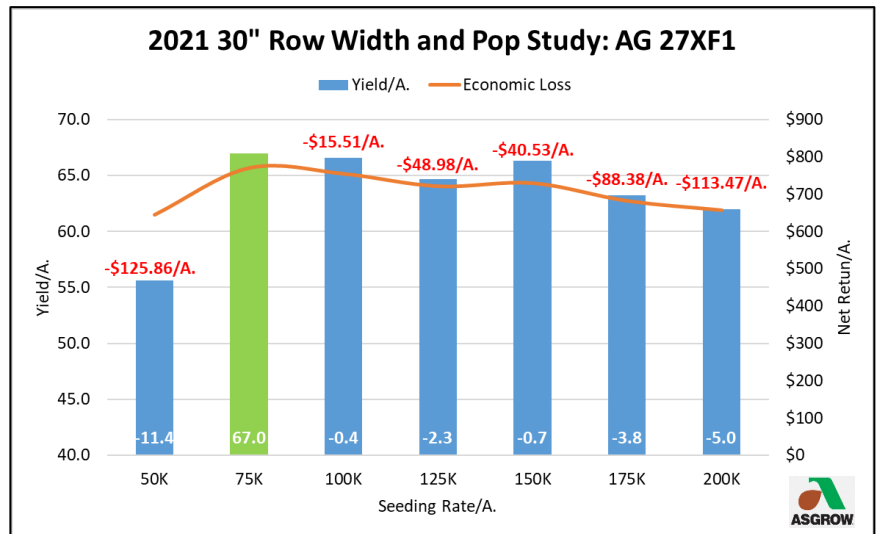
SB Price: \$11.98

Soybean Row Width & Seeding Rate Study

Objective: This trial evaluates the agronomic and economic impact of planting two soybean varieties (Asgrow 27X1XF and Golden Harvest 3192XF) at seeding rates ranging from 50K to 200K in 20" and 30" row spacing. It should be noted that these soybeans were planted on May 24th, considered to be a later than ideal planting date.

30" Wide Row Results:

- ✓ Asgrow 27XF1 achieved both agronomic and economic optimum seeding rate at 75K/A.
 - ✓ High yield was 67 Bu/A.
 - ✓ Low seeding rates of 50K/A. resulted in yield crash of **-11.4 Bu/A.**, proving economic losses of over **-\$125/A.**
 - ✓ Over-seeding at 175-200K rates resulted in yield loss of **-3.8 Bu/A** to **-5.0 Bu/A.** with respective economic losses of **-\$88.38** to **-\$113.47/A.**
-
- Golden Harvest 3192XF achieved both agronomic and economic seeding rate at 125K/A.
 - High yield was 66.2 Bu/A.
 - Low seeding rates of 50K/A. resulted in yield crash of **-12.9 Bu/A.**, proving economic losses of over **-\$122/A.**

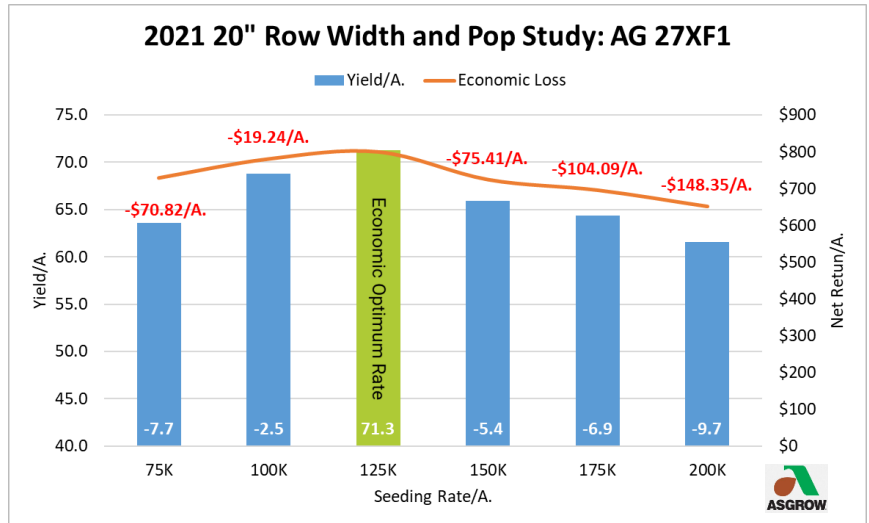


Soybean Row Width & Seeding Rate Study Continued

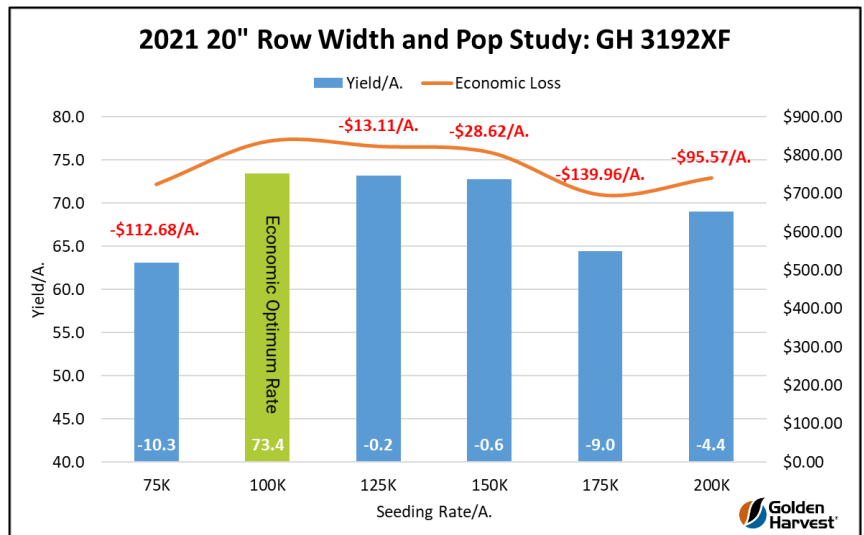
Below are results for 20' narrow soybeans. Please note, 50K seeding rates in 20" were not available.

20" Narrow Row Results:

- ✓ Asgrow 27XF1 achieved both agronomic and economic optimum seeding rate at 125K/A.
- ✓ High yield was 71.3 Bu/A.
- ✓ Lower seeding rates of 75K/A. resulted in yield crash of **-7.7 Bu/A.**, proving economic losses of over **-\$70A.**
- ✓ Over-seeding at 150-200K rates resulted in yield losses of **-5.4 Bu/A** to **-9.7 Bu/A.** with respective economic losses of **-\$75.41, -\$104.09** and **-\$148.35/A.**



- Golden Harvest 3192XF achieved both agronomic and economic seeding rate at 100K/A.
- High yield was 73.4 Bu/A.
- Low seeding rates of 75K/A. resulted in yield crash of **-10.3 Bu/A.**, proving economic losses of over **-\$112/A.**
- Over-seeding at 175-200K resulted in yield losses of **-4.4 Bu/A** to **9.0 Bu/A.** with respective economic losses of **-\$95.57 and -\$139.69/A.**

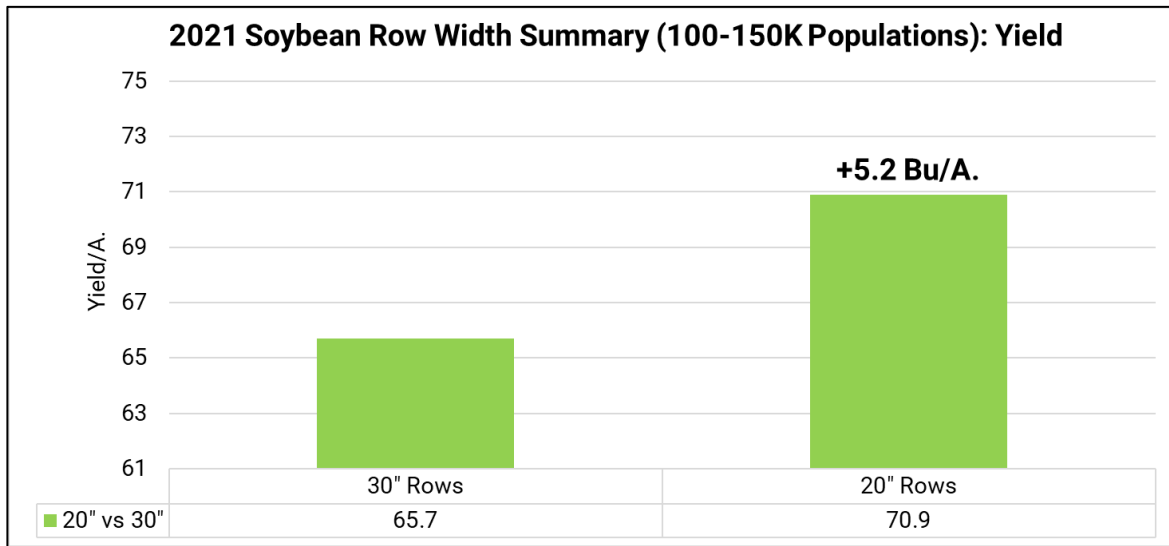


➤

Soybean Row Width & Seeding Rate Study Continued

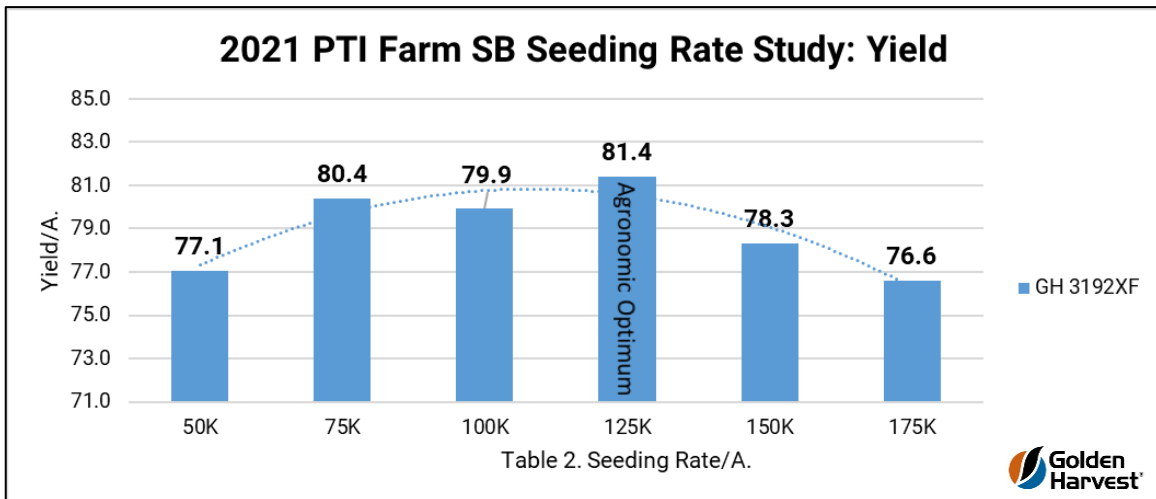
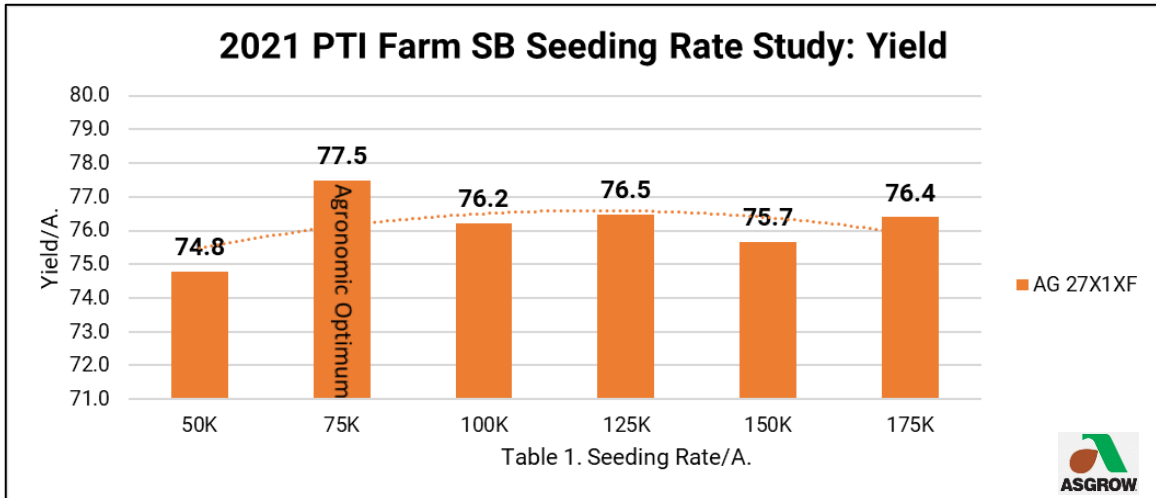
20" vs 30" Row Width Summary:

- ✓ Over all seeding rates, 20" rows out-performed wide 30" rows by +4.6 Bu/A.
- ✓ However, in popular or common seeding rates today of 100K to 150K, 20" rows out-performed wide 30" rows by +5.2 Bu/A.
- ✓ +5.2 Bu/A. yield gains at \$11.98/Bu. soybeans proved additional revenue of +\$62.30/A.



Early Planting Soybean Seeding Rate Study

Objective: This trial evaluates the agronomic and economic impact of planting two soybean varieties at seeding rates ranging from 50K to 200K in 30" row spacing at an early plant date of April 5th.



Results: Table 1. illustrates Asgrow® 27XF1 achieved agronomic optimum seeding rate at 75K/A. with yields at 77.5 Bu/A. Lowest 50K seeding rates proved losses of **-2.7 Bu/A.** As seeding rates were increased above 75K, yields proved a narrow range from 75.7 to 76.5 Bu/A.

Golden Harvest® 3192XF achieved agronomic optimum seeding rate at 125K/A. with yields at 81.4Bu/A. Lowest 50K seeding rates proved losses of **-4.3 Bu/A.** As seeding rates were pushed over 81.4 Bu/A., yield fell by **-3.1 Bu/A to -4.8 Bu/A.**

Early Planting Soybean Seeding Rate Study

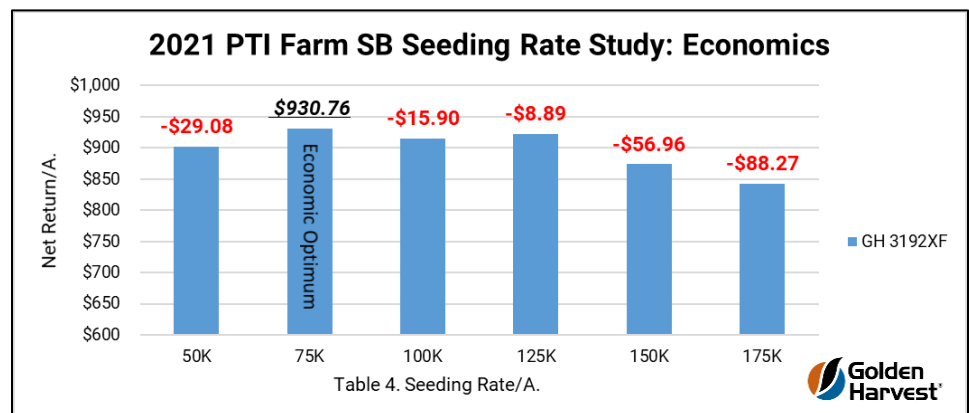
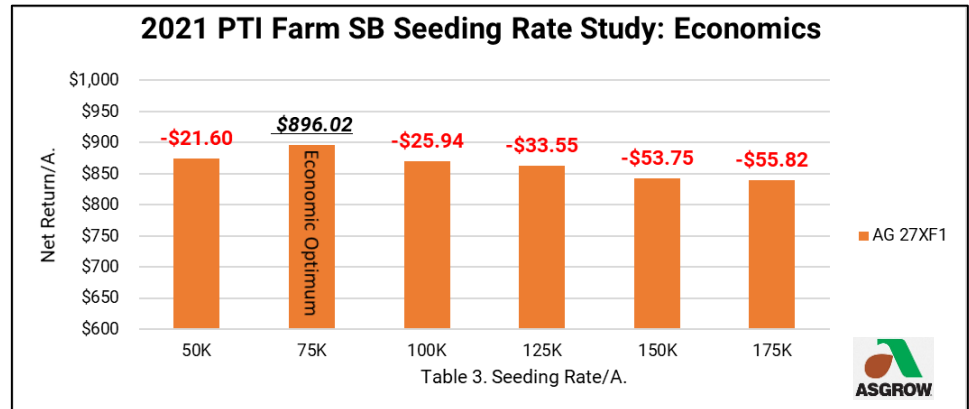
The telling story in this study is the economics. After seed cost, Asgrow 27XF1 achieved economic optimum rate at 75K seeding rates (Table 3). As seeding rates fell to 50K, net return diminished by **-\$21.60/A**. As seeding rates were accelerated to 100K, 125K, 150K, and 175K, economic returns diminished by **-\$25.94/A.**, **-\$33.55/A.**, **-\$53.75/A.** and **-\$55.82/A.**

Golden Harvest 3192XF held its economic optimum ranking at the 75K seeding rate as well. As populations were reduced to 50K, net return diminished by **-\$29.08/A**. As seeding rates went higher from the optimum 75K, returns fell by **-\$15.90/A.**, **-\$8.89/A.**, **-\$56.96/A.** and **-\$88.27/A.** respectively.

More work needs to be done to fully understand seeding rates in various row widths with today's soybean trait platforms. In the last three years, testing at the PTI Farm has indicated that if a grower decreases seeding rates,

singulates those soybeans, and selects a soybean with proper architecture appropriate for row width, great yield potential can exist while reducing seeding expense.

It is important to note that low seeding rates need special attention to weed control. In narrow rows (<30") it may be less of a concern, but with the 30" rows in this study we have had weeds creep through late in the season due to increased sunlight and less overall shading within the soybean canopy. Soil type also needs special attention. This study is conducted on mostly flat, black and beautiful soils with little to no variability. As a producer would encounter soil type changes or variability in the field, seeding rate changes may need to occur. For example, in drought stress clay knobs, a higher seeding rate may be needed to accomplish row canopy and to protect moisture. Conversely, darker soils on lower elevations may need lower seeding rates just as this study portrays.

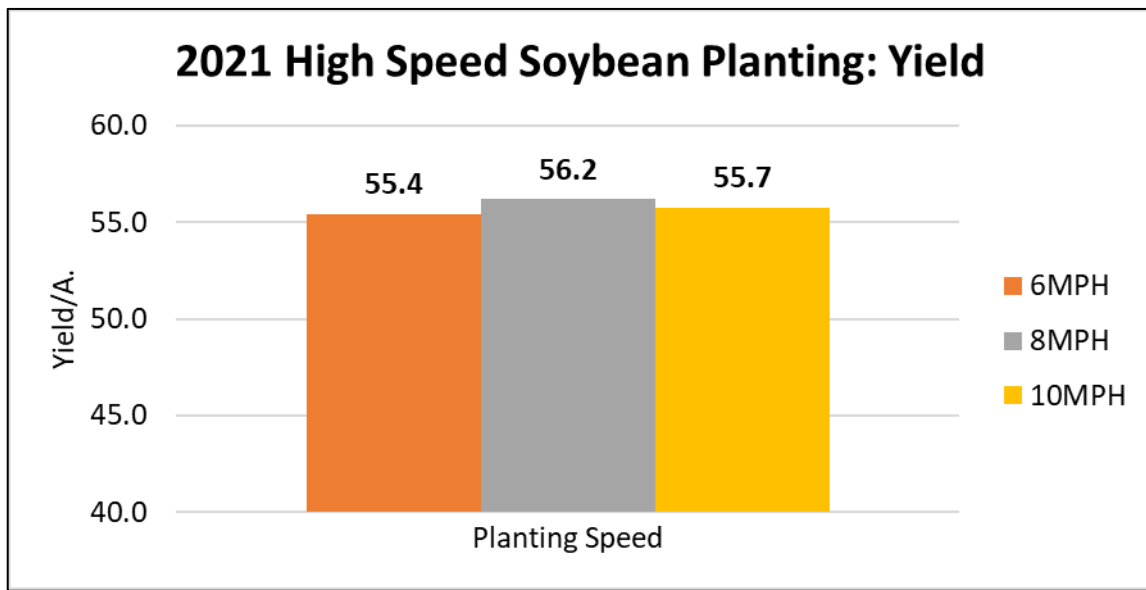
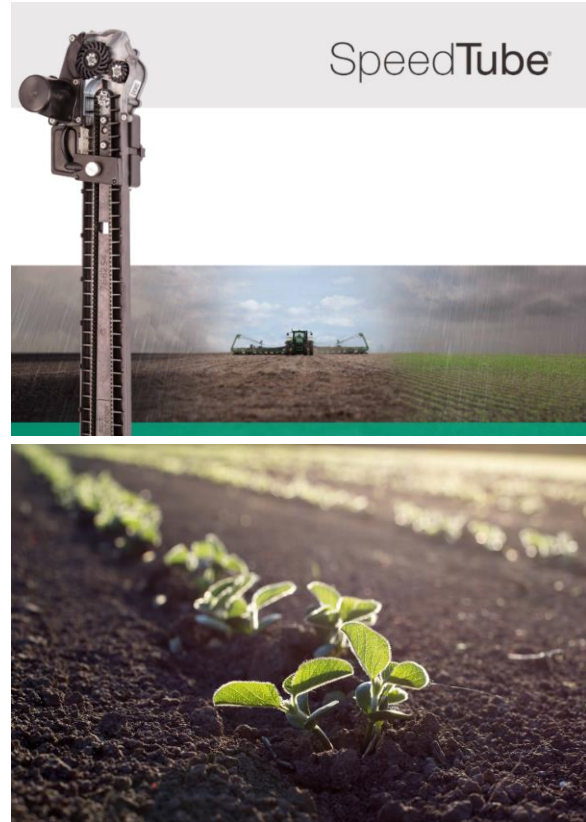


High Speed Soybean

Objective: To evaluate yield response of planting speeds 6, 8, and 10 MPH with SpeedTube® system. This high-speed planting technology takes the place of conventional seed tubes and consists of a flighted belt. By transporting each seed to the furrow, there is no opportunity for seeds to ricochet into the trench. Even at twice normal planting speeds, seed arrives safely at the bottom of the trench, spaced evenly, every time.

Results: Using SpeedTube® technology, there was only a 0.8 Bu/A. range difference between the very common producer planting speeds of 6MPH to 10MPH. 8MPH plantings did however, prove optimum speed at 56.2 Bu/A.

This data would suggest that growers can plant at significantly higher speeds with SpeedTube® technology without sacrificing planter performance.



Planting Date: 5/20 Variety: AgriGold G2905XF Population: 130K Row Width: 30" Rotation: BAC Seeds/#: 3000

Tillage: Conventional 56 Cell Soybean Disc with Soybean Singulator

Soybean Air Seeder Study:

Objective: This trial evaluates the agronomic and economic impact of planting soybeans with an air seeder in 7.5" rows compared to 20" and 30" row spacing.



SUNFLOWER® 9831 7.5" AIR DRILL FEATURES

- Dedicated Product Metering
- Meter Access
- Depth Control
- Wireless Blockage Monitoring



CASE IH® EARLY RISER® 2150 30" ROW PLANTER FEATURES

- 20|20® Monitor
- vSet®
- vDrive®
- DeltaForce®
- SpeedTube®



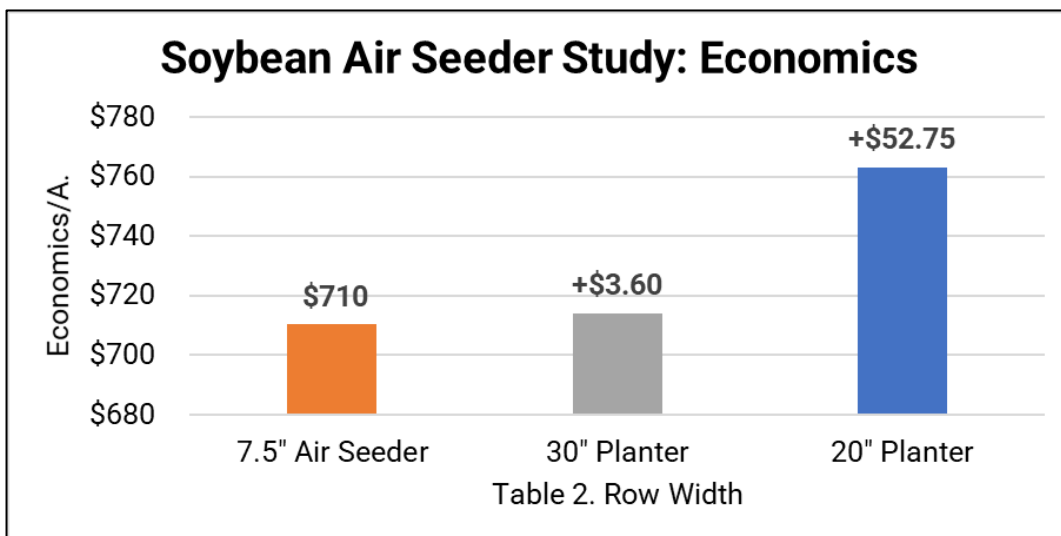
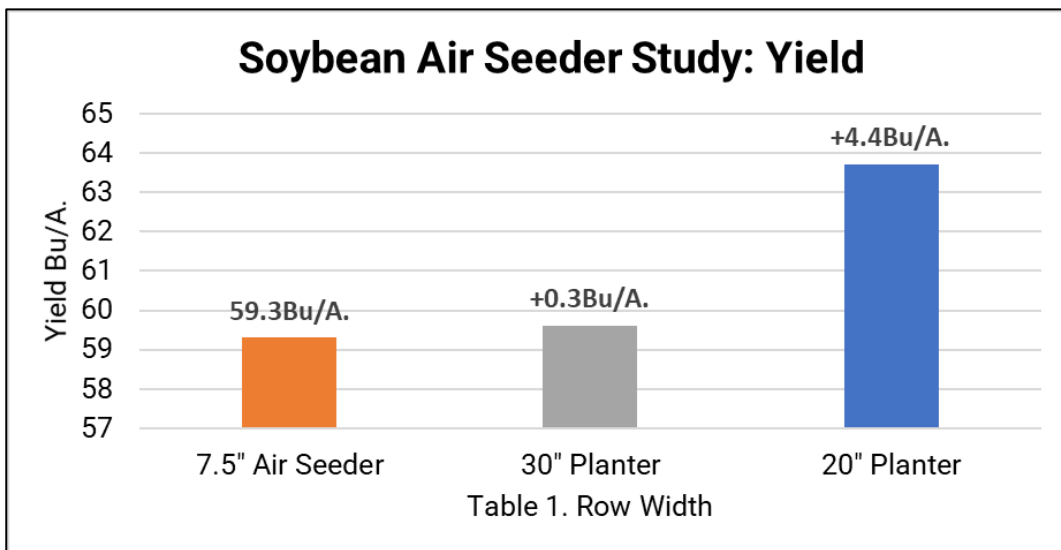
HARVEST INTERNATIONAL™ ULTRAPLANT™ SERIES 40' 20" PLANTER FEATURES

- 20|20® Monitor
- vSet®
- vDrive®
- DeltaForce®

Soybean Air Seeder Study:

Results: Tables 1-2. illustrate the 7.5" air seeder resulted in negative **-4.4Bu/A** yield losses compared to 20" rows and **-0.3Bu/A** compared to the 30" rows. Consequently, the air seeder system resulted in economic losses of **-\$52.75/A.** and **-\$3.60/A.** respectively.

At the PTI Farm we have seen consistent results with narrow row 20" soybeans outperforming wide 30" rows by nearly 4.0Bu/A. Even though the air seeder is classified as narrow rows, it should be noted the lack of precision components needed for accurate down force, seed to soil contact and singulation.



Soybean Rolling Study

Objective: To study the yield and economic impact of rolling soybeans. A Brandt roller (Figure 1.) was used in replicated strips at two different growth stages of V2 and V4.

The benefits of using a roller in soybeans include the following:

- Pushing or pressing rocks into soil to avoid harvest issues
- Lays corn residue flat to aid in cleaner seed at harvest
- Stimulate reproductive growth after rolling damage occurs



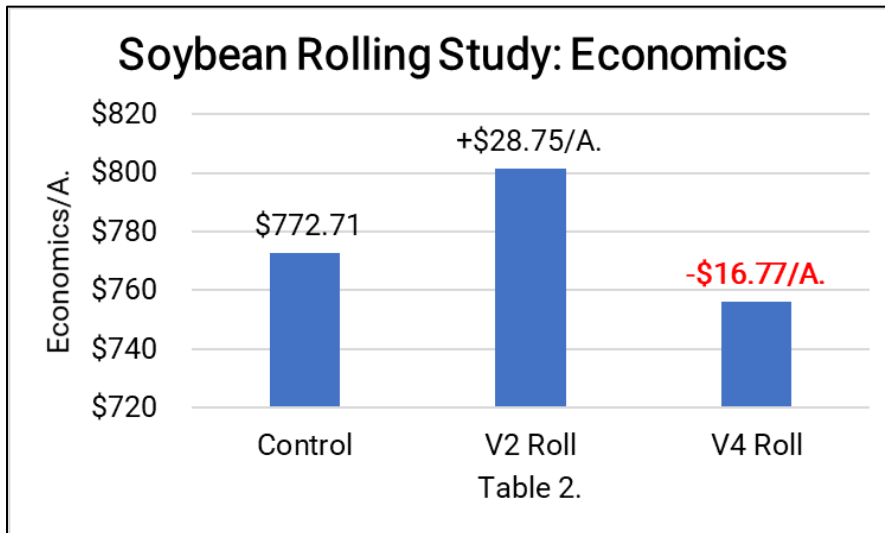
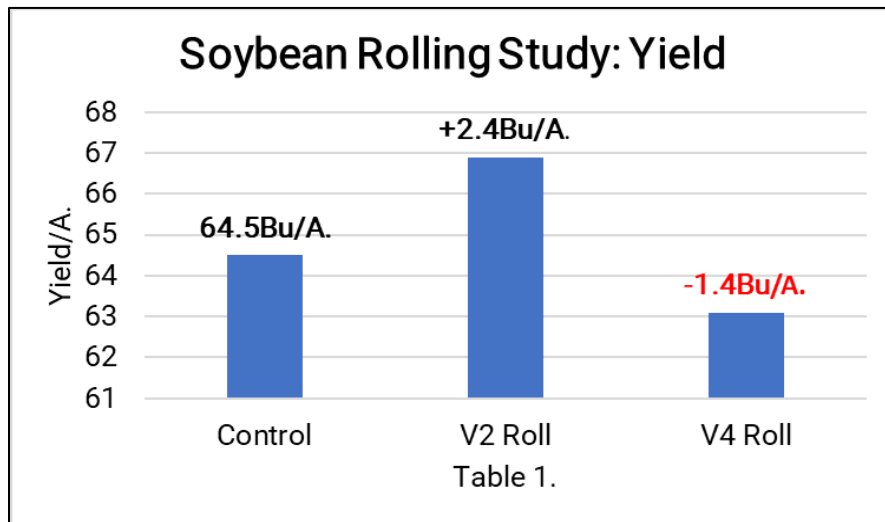
Figure 1. Brandt® Roller



Soybean Rolling Study

Results: As shown in Tables 1-2, soybeans rolled at the V2 growth stage resulted in yield gains of +2.4Bu/A. and positive economic gains of +\$28.75/A. However, rolling soybeans at V4 growth stage resulted in yield losses of **-1.4Bu/A.** and negative economic losses of **-\$16.77/A.**

Being year 1 of this ongoing multi-year study, we look forward to evaluating the overall advantages of rolling soybeans and determining the best growth stage to do so.



Soybean Cover Crop Study:

Objective: This trial is designed to evaluate the yield and economic benefits of a cover crop system in a soybean/corn rotation. To evaluate long-term benefits, this trial has been designed as a 10-year study. 45#/A. of cereal ryegrass was planted in the fall of 2020 (Figure 1.) and strip-till was then used as the primary tillage system after the ryegrass emerged.

In the spring, soybeans were planted directly on the fall strips and into green cover crop (Figure 2).

Two termination timings were evaluated, one early at soybean V3 growth stage and another when ryegrass began heading. Due to this late termination, the ryegrass was then rolled (Figures 3-4.) to allow soybeans more sunlight and to use the ryegrass to hold soil moisture.

Figure 1. Fall Cover Crop Seeding



Figure 2. Planting on Strip-Till into Green Cover



Figure 3. Soybeans after Rolling



Figure 4. Rolling of Soybeans



Soybean Cover Crop Study Continued

Results: Table 1. illustrates soybeans proved +1.8 Bu/A. yield gains when early termination was implemented compared to the non-cover crop control. However, **-13.5 Bu/A.** yield losses were incurred when late termination treatments allowed for ryegrass to get too growthy, causing shading, competition for water and nutrients, as well as being a harbor for pests.

Table 2. depicts net return on investment of the cover crop systems. Early terminations resulted in minor losses of **-\$1.29/A.**, while late termination resulted in significant losses of **-\$184.58/A.** in year 1 of our long-term study.

Due to heavy rains during the early growing season in May, the increased residue also acted as a sponge or wick and kept soils saturated and oxygen deficient (anaerobic). What normally could be a great advantage to cover crops, this year proved to be yield limiting.

The prairie vole (*Microtus ochrogaster*) (Figure 5.) was also a pest very prevalent in cover crops and/or no-till soybeans at the PTI Farm in 2021. Ryegrass served as an excellent host to voles and soybean feeding was very prevalent.

It should be noted that rolling of soybeans (Figure 4.) did not appear to be a yield limiting factor. In fact, rolling of soybeans in large residue situations usually is a yield enhancer as it lays residue down and allows more sunlight capture. This year, the wet, saturated soils and heavy vole pressure proved too detrimental and offset any of this advantage.

We look forward to continuing to test the use of cover crops in a continuous bean after corn rotation and to evaluate yield and economics of the system, while taking a close look at what cover crops can offer regarding soil health improvement.

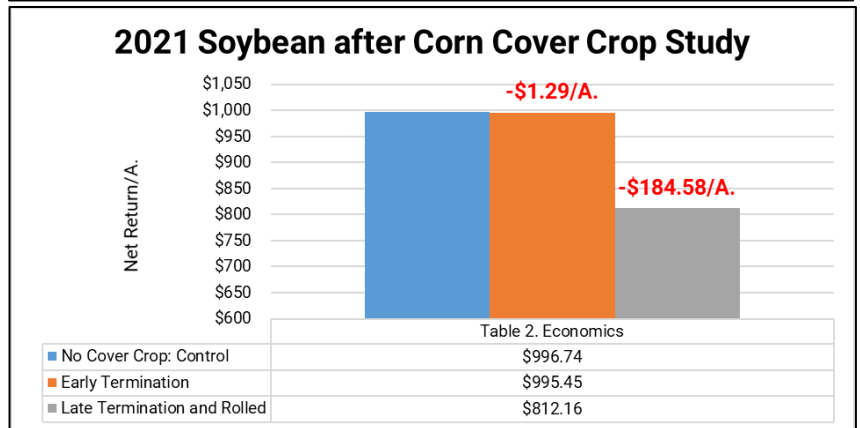
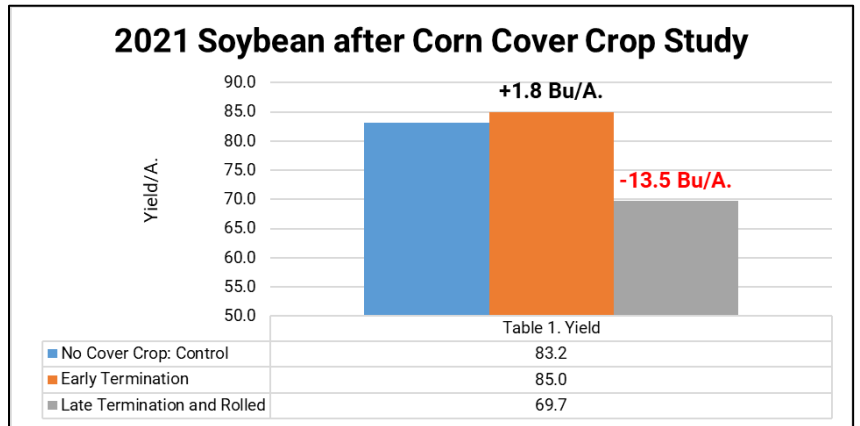


Figure 5. Prairie vole (*Microtus ochrogaster*)



Broadcast vs Banding Dry Fertilizer Study

Objective: To evaluate yield and economics of traditional broadcast applications of dry fertilizer compared to 8" deep high concentrated strip-till banding.

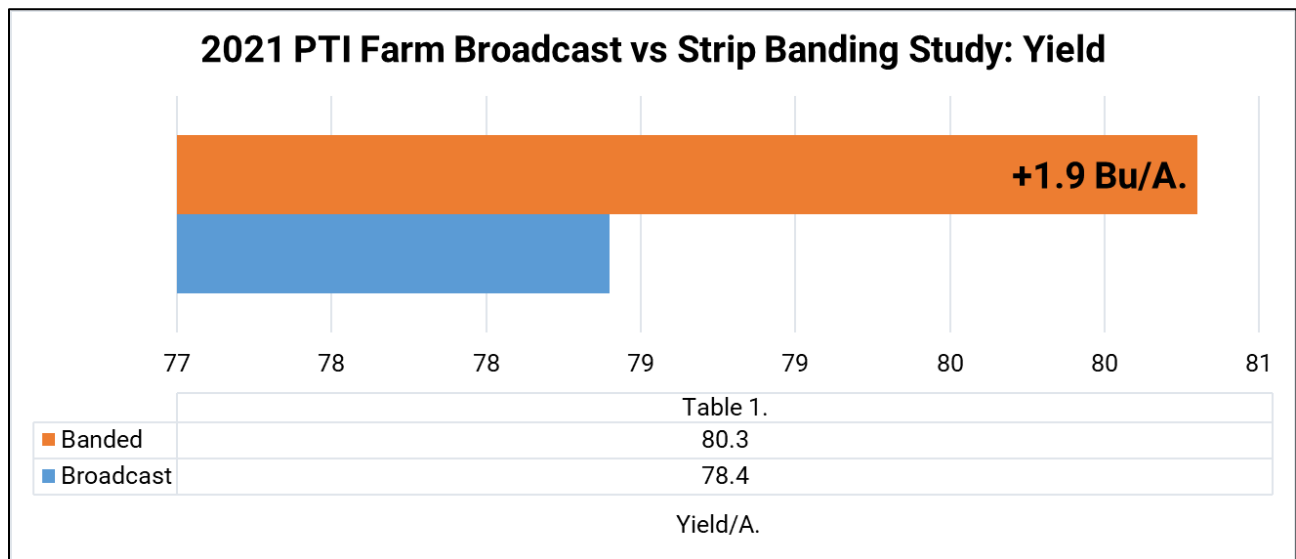
Based upon soil test results and yield goals of 250 Bu/A. corn in a corn/soybean irrigated rotation, 260# 18-46-0 and 140# 0-0-60 was applied in a traditional broadcast surface application made with a traditional spinner truck (Figure 1). Using the same fertilizer rates, a strip-till bar was used to place fertilizer in high concentrated strips 8" deep on 30" corn rows (Figure 2). Corn was then planted directly into the strips above the 8" fertilizer placement. A KUHN Krause Gladiator® pulling a Montag Equipment 2208 Gen 2 fertilizer cart was used to implement this testing program for 2021.

Results Table 1. illustrates strip-till fertilizer resulted in +1.9 Bu/A. yield gains over traditional broadcast applications. Soybean yield from broadcast fertilizer averaged 78.4 Bu/A., while strip-till pushed over the 80 mark and resulted in yields of 80.3 Bu/A.

Figure 1. Broadcast Dry Fertilizer



Figure 2. Strip-Till Banded Fertilizer

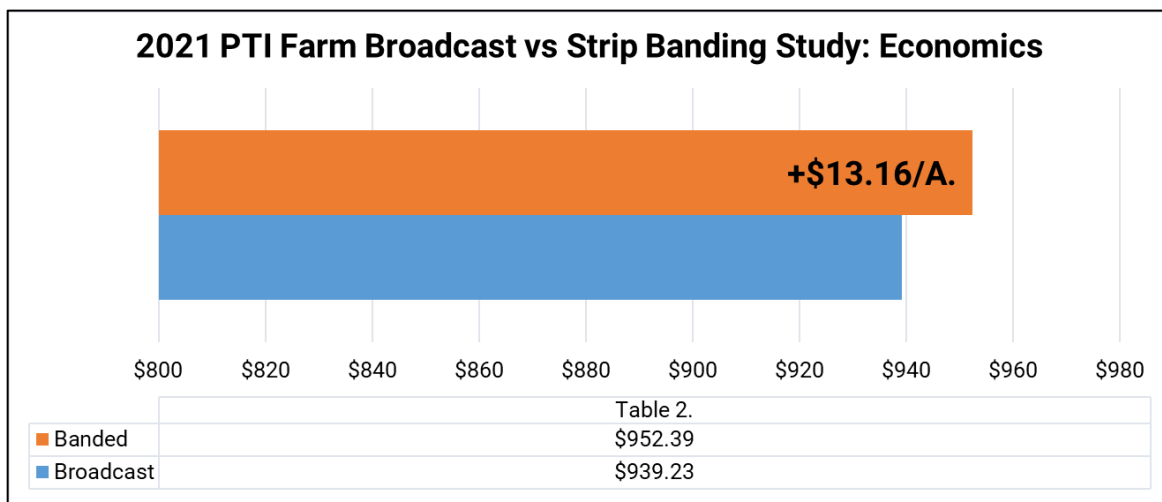


Broadcast vs Banding Dry Fertilizer Study Continued

Using University of Illinois Machinery Cost Estimates in Figure 1., strip-till resulted in additional costs of +\$9.60/A. in comparison to a conventional tillage program. Using this cost scenario, Table 2. illustrates the economic impact from our 2021 study. Strip-till, with its tillage and fertility system, posted positive economic gains of +\$13.16/A. over a conventional tillage system.

Figure 1. University of IL Machinery Cost Estimates

Tillage Practice	Category	Cost
Conventional	Soil Finisher	\$ 11.10
	Plant	\$ 17.20
	Fertilizer Spread	\$ 3.00
	Total:	\$ 31.30
Strip Till	Strip	\$ 17.30
	Plant	\$ 17.20
	Burndown	\$ 6.40
	Total:	\$ 40.90



Broadcast vs Banding Rate Efficiency Study

Objective: To evaluate yield and economics of traditional broadcast applications of dry fertilizer compared to concentrated strip-till bands applied 8" in depth under the corn row.

Based upon soil test results and yield goals of 70 Bu/A. soybeans in a corn/soybean rotation, 165# 18-46-0 and 180# 0-0-60 was applied as a recommended fertility application from a recent soil test.

To study placement efficiency, dry fertilizer was applied in a traditional broadcast surface application as a spinner truck (Figure 1). Using the same fertilizer rates, a strip-till bar was used to place fertilizer in high concentrated strips 8" deep on 30" corn rows (Figure 2). Soybeans was then planted directly into the strips above the 8" fertilizer placement. Soybeans was also planted in a strip-till situation with the broadcast fertilizer, however as surface applied on top of the fall strips. A KUHN Krause Gladiator® pulling a Montag Equipment 2208 Gen 2 fertilizer cart was used to implement this testing program for 2021.

To then study rate efficiency, fertilizer was applied at the following rate structure in both strip-till bands and broadcast applications:

- ✓ 100% Fertilizer Rate
- ✓ 75% Fertilizer Rate
- ✓ 50% Fertilizer Rate
- ✓ 25% Fertilizer Rate
- ✓ 0# Rate

Figure 1. Broadcast Dry Fertilizer



Figure 2. Strip-Till Banded Fertilizer with Montag cart



Figure 3. KUHN Krause strip-till unit



Broadcast vs Banding Rate Efficiency Study Continued

Results: Table 1. illustrates the yield of all rates in band and broadcast applications. High concentrated bands of fertilizer surpassed broadcast spreading yields at every individual rate%.

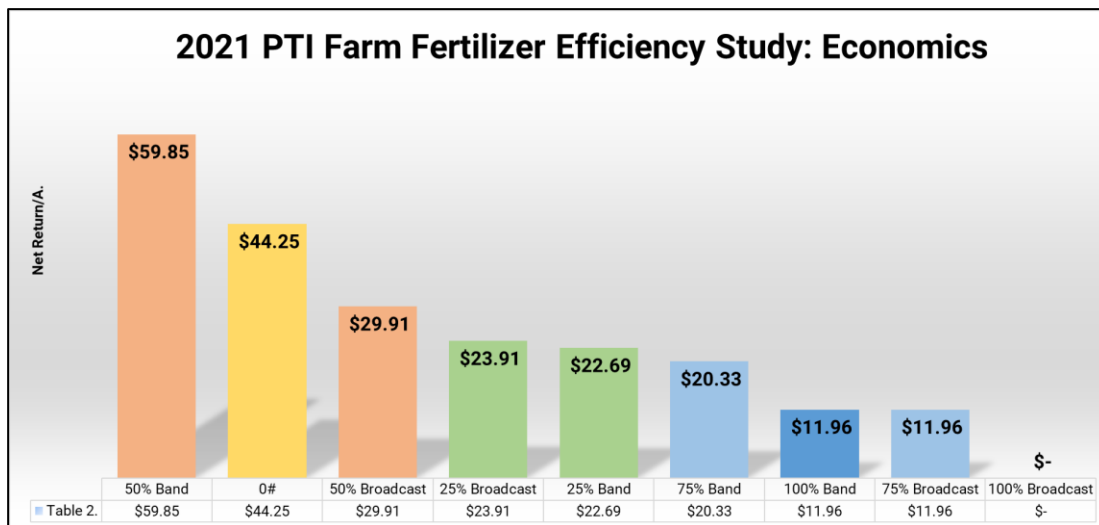
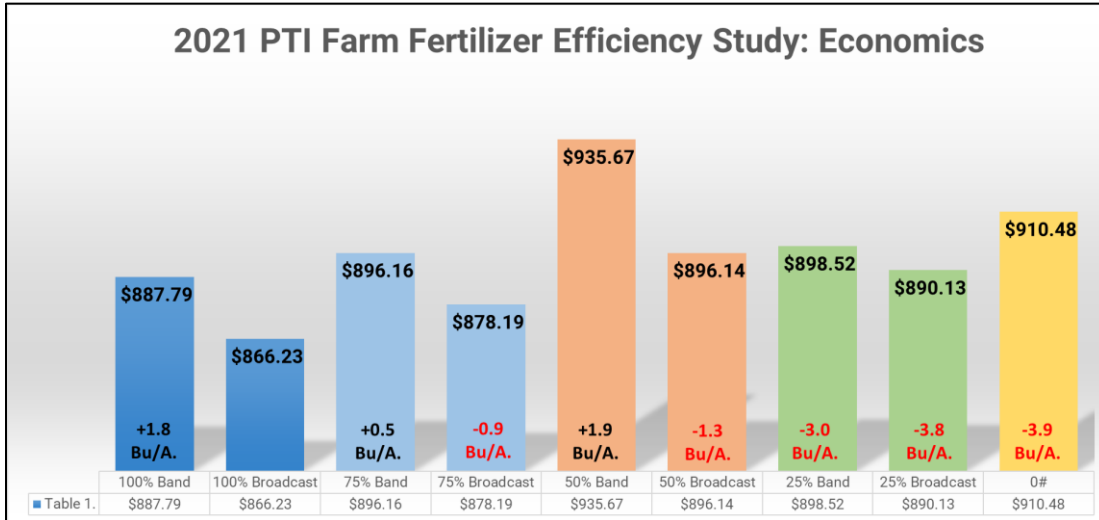


Table 2. tells the story very well as it reveals higher amounts of fertilizer did not pay. In fact, 0# of fertilizer suffered yield losses of **-3.9 Bu/A.**, however out-performed the 100% broadcast application by +\$44.25/A. due to zero fertility cost. Only the 50% banded application (+\$59.85/A.) offered economic gains over the 0# rate. All other rates and placement outperformed the 100% broadcast application economically.

Marco QuickGrow LTE FurrowJet® Study

Objective: To evaluate the yield and net return of Marco Fertilizer's QuickGrow LTE 6-20-4-.25Zn-2.7S liquid starter fertilizer. QuickGrow LTE is a 70% polyphosphate and 30% orthophosphate formulation of nitrogen, phosphorus, potassium, sulfur, and EDTA Zn. Marco LTE starter treatments are applied at 4, 6 and 8Gal/A. as a FurrowJet® wing treatment only (Figure 1 & 2).

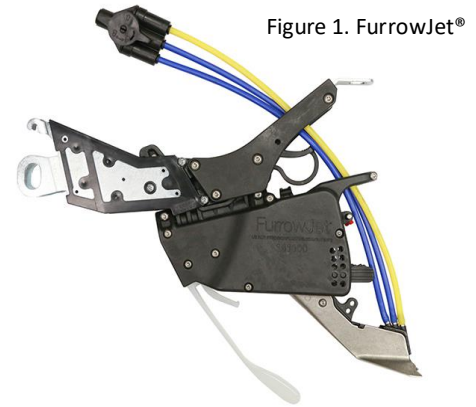


Figure 1. FurrowJet®

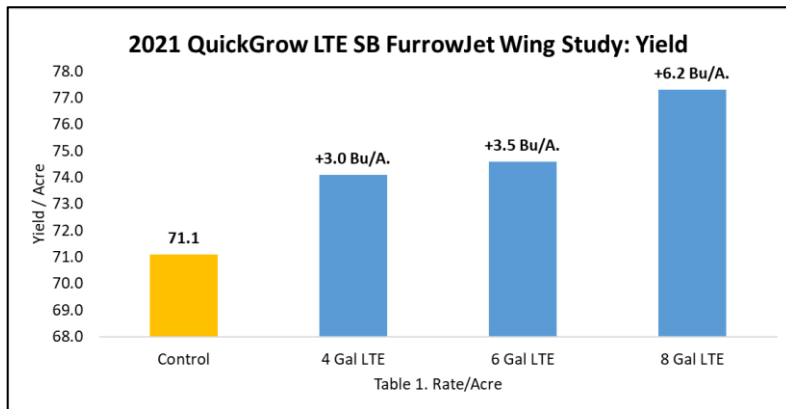
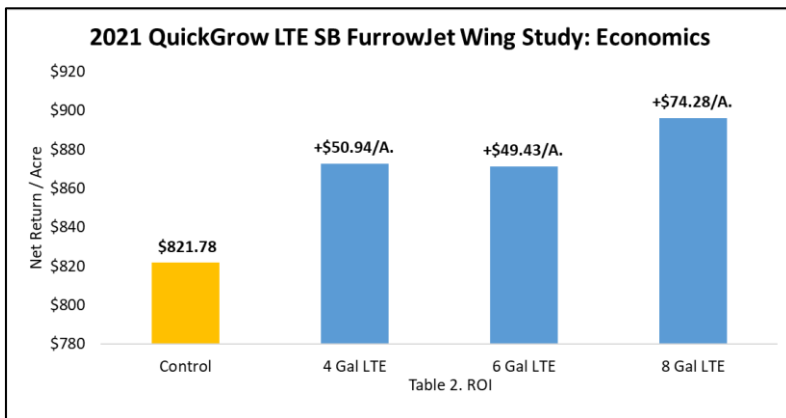


Figure 2. FurrowJet® Wing Placement



Results: 8 Gal/A. rates showed both agronomic and economic optimum rate with yield gains of +6.2 Bu/A. and a return on investment of +\$74.28/A. (Tables 1-2).

Planting Date: May 17

Variety: Asgrow 27XF1

Population: 130K

Row Width: 30"

Rotation: BAC

SB Price: \$11.98

Marco LTE: \$3.75/Gal

Dry Fertilizer Reallocation: \$30/Acre

Marco BioMarc Micronutrient FurrowJet® Study

Objective: To evaluate the yield and net return of Marco Fertilizer’s BioMarc, a unique combination of naturally extracted biostimulants including kelp-based materials, coupled with nutrient-enabling technologies that enhance liquid fertilizer performance. For this study, BioMarc is tank-mixed with QuickGrow LTE 6-20-4-.25Zn-2.7S liquid starter fertilizer. QuickGrow LTE is a 70% polyphosphate and 30% orthophosphate formulation of nitrogen, phosphorus, potassium, sulfur, and EDTA Zn. Marco LTE + BioMarc starter treatments are applied at 4, 6 and 8Gal/A. as a FurrowJet® *wing* treatment only (Figure 1 & 2).

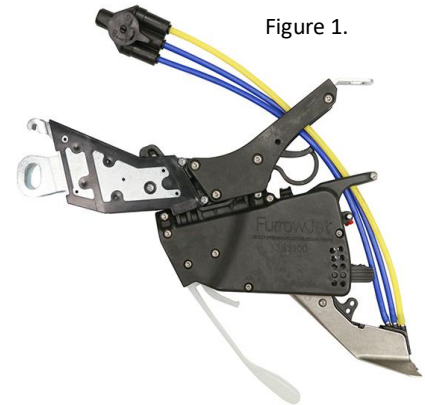
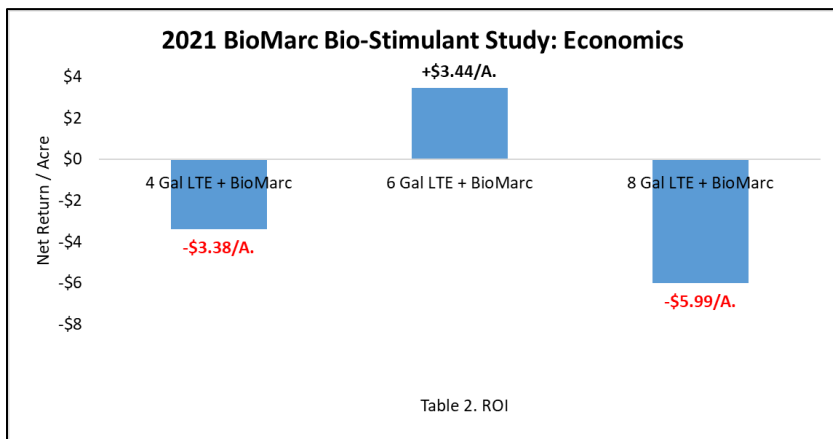
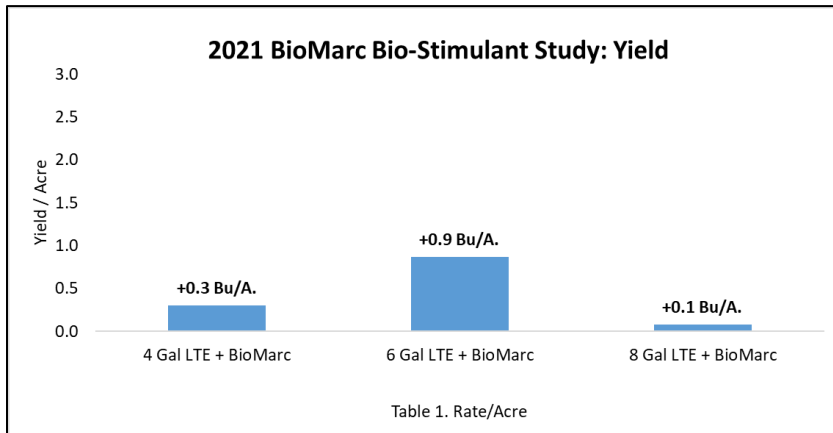


Figure 1.



Results: Tables 1-2 illustrate BioMarc treatments provided +0.1 to +0.9 Bu/A. average yield gains. 1qt BioMarc at the 6Gal/A. rate proved economic gains of +\$3.44/A. While both the 4Gal and 8Gal/A. rates proved economic losses of -\$3.38/A. and -\$5.99/A. respectively.

Planting Date: May 17 Variety: Asgrow 27XF1 Population: 130K Row Width: 30" Rotation: BAC SB Price: \$11.98

Marco LTE: \$3.75/Gal BioMarc: \$28/Gal Dry Fertilizer Reallocation: \$30/Acre

Nachurs® Start2Finish™ Soybean Fertility Trial



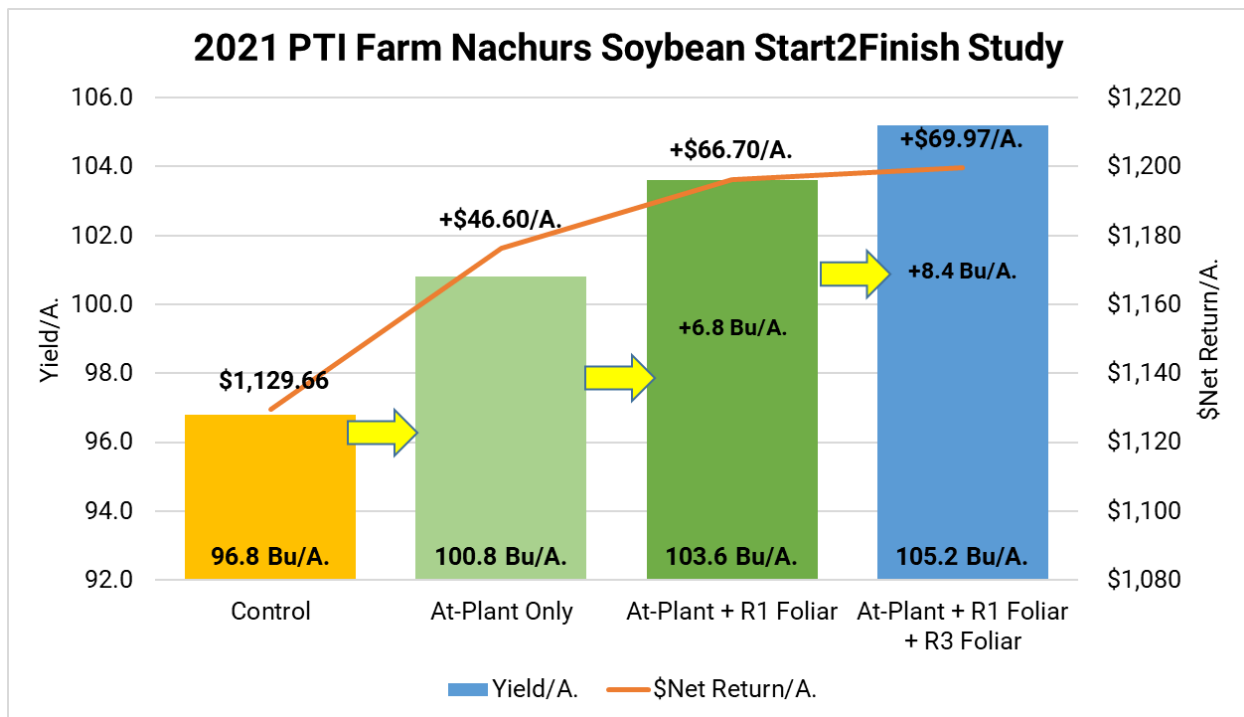
Objective: To evaluate the effect on yield and economics of Nachurs Start2Finish soybean fertility program. This program consists of the following treatments:

At-Plant: 3 Gal/A. TripleOption® applied via FurrowJet® system 3-way band

At-Plant: 3 Gal/A. K-Fuse® applied via Conceal® dual band system

R1 Foliar: 1 Qt/A. FinishLine® + 1 Gal/A. Balance®

R3 Foliar: 1 Qt/A. FinishLine + 1 Gal/A. K-Fuel®



Results: At-plant FurrowJet® and Conceal® treatments of TripleOption and K-Fuse resulted in +4.0 Bu/A. yield gains with positive net returns of +\$46.60/A.

R1 foliar treatments of FinishLine and Balance proved additional yield gains of +2.8 Bu/A. with positive net returns of +\$20.10/A.

R3 foliar treatments provided additional +1.6 Bu/A. yield gains with positive net return of +\$3.27/A.

Planting Date: 4/27 Variety: GH 3192XF Population: 110K Row Width: 30" Rotation: BAC SB Price: \$11.98 Application Cost: \$6/A.

\$30/A Fert. Re-Allocation Balance: \$3.84/A. K-Fuse: \$4.80/Gal FinishLine: \$14.40/A. TripleOption: \$5.64/Gal K-Fuel: \$6.30/Gal

AgroLiquid® Starter Fertilizer Study

Objective: To evaluate the yield and economic impact of a soybean liquid starter fertilizer nutritional program from AgroLiquid® using FurrowJet® and Conceal® (Figure 1.) The protocol consists of the following:



Figure 1. Conceal® and FurrowJet® Placement

Results: Table 1. illustrates the AgroLiquid fertility program achieved average yield gains of +3.8 Bu/A. Table 2. depicts net returns tallied a positive return on investment of +\$25.99/A.



Figure 2..

Product/A.		Application
2-Gal Spring-uP®	4-15-3	FurrowJet®
1 Gal/A. SureK®	2-1-6	FurrowJet®
0.25 Gal/A. Micro 500™	.02B-.25Cu-.37Fe-1.2Mn-1.8Z	FurrowJet®
0.25 Gal/A. Manganese	4% Manganese Sulfate	FurrowJet®
.125 Gal/A. eNhance™	7-0-0-8.7S-.07MN-.07Zn	Conceal®
2 Gal AccesS®	7-0-0-17S-.25Fe-.05Mn-.05Zn	Conceal®
2 Gal/A. SureK	2-1-6	Conceal®

2021 AgroLiquid SB Study: Yield

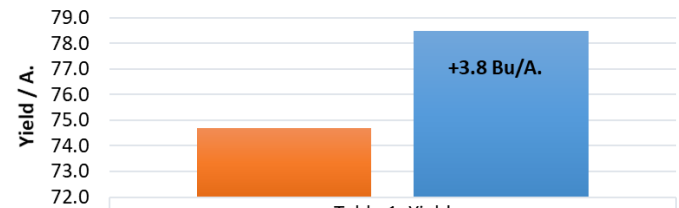


Table 1. Yield

Check	74.7
AgroLiquid Program	78.5

2021 AgroLiquid SB Study: Economics

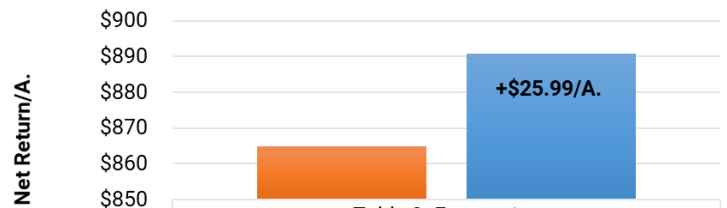


Table 2. Economics

Check	\$864.91
AgroLiquid Program	\$890.90

Planting Date: 4/27 Variety: Asgrow 27XF1 Population: 130K Row Width: 30" Rotation: BAC Soybean Price: \$11.98 \$30/A Fert. Reallocation

Spring-uP: \$5.17/Gal SureK: \$6.08/Gal Micro500: \$17.18/Gal Manganese: \$19.66/Gal eNhance: \$17/Gal AccesS: \$4.81

Stoller®USA FurrowJet® Study

Objective: This soil engaging fertility application trial evaluates the yield and net return of Stoller®USA’s Bio-Forge® Advanced and Charge 12%™ applied in a FurrowJet® tri-band along with Harvest More™ Urea Mate applied in a Conceal® dual band application (Figures 1).

Bio-Forge® Advanced is an abiotic stress mitigator in plants. It does so by facilitating greater uptake and utilization (metabolism) of key nutrients, like nitrogen, from available resources including soil-bound nutrients.

Charge 12% is an organic humic acid that improves nutrient utilization, root development, and soil aggregation. It is OMRI Listed for use in organic production.

Stoller’s Harvest More™ Urea Mate 5-10-27 is fertilizer that contains 5% Nitrogen, 10% Phosphorous, 27% Potassium, along with Boron, Calcium, Magnesium, Manganese, Cobalt, Copper, Zinc and Molybdenum.

Charge 12%

CONTAINS NON-PLANT FOOD INGREDIENT(S):
GUARANTEED ANALYSIS:
 Soil Amending/Active Ingredient(s):
 Humic Acids (from Leonardite)12%
 Total Other/Inert Ingredient(s): (aqueous solution).....88%

Bio-Forge® Advanced

3-0-1
GUARANTEED ANALYSIS
 Total Nitrogen (N).....3%
 1.25% Urea Nitrogen
 1.75% Other Water Soluble Nitrogen
 Soluble Potash (K₂O).....1%
 Cobalt (Co).....1%
 1% Chelated Cobalt (Co)
 Molybdenum (Mo).....1%



HARVEST MORE™ UREA MATE 5-10-27

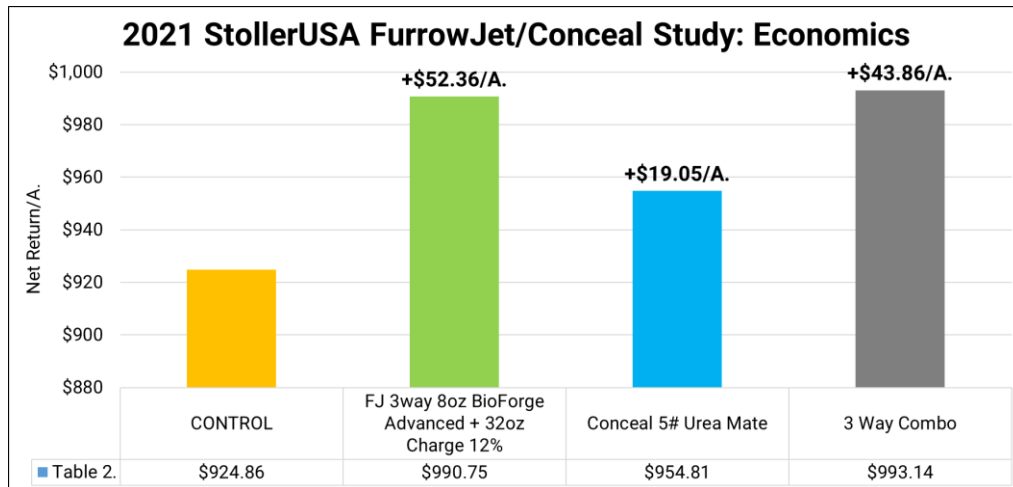
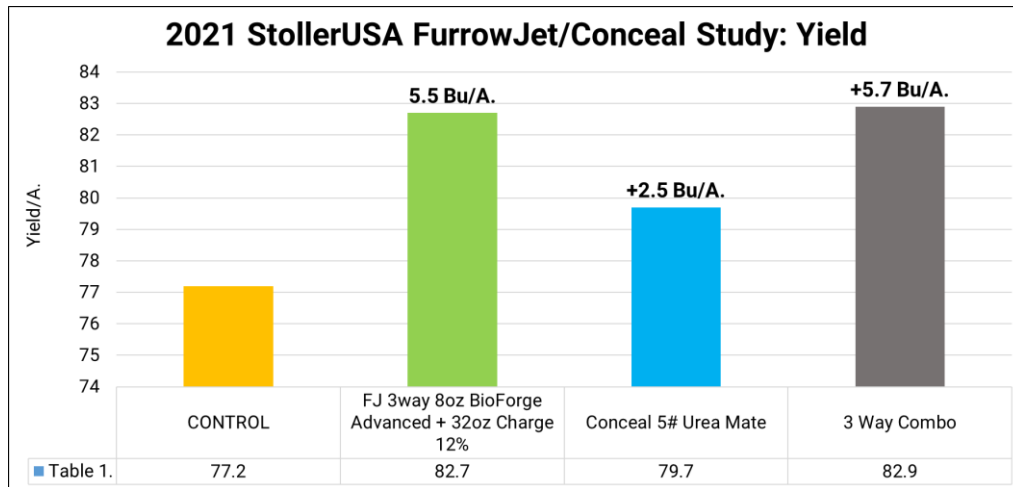
GUARANTEED ANALYSIS

Total Nitrogen (N)	5%
5% Urea Nitrogen	
Available Phosphate (P ₂ O ₅).....	10%
Soluble Potash (K ₂ O).....	27%
Calcium (Ca).....	4%
4% Chelated Calcium	
Magnesium (Mg).....	1.5%
1.5% Chelated Magnesium	
Boron (B).....	0.15%
Cobalt (Co).....	0.008%
0.008% Chelated Cobalt	
Copper (Cu).....	0.3%
0.3% Chelated Copper	
Manganese (Mn).....	0.5%
0.5% Chelated Manganese	
Molybdenum (Mo).....	0.008%
Zinc (Zn).....	0.5%
0.5% Chelated Zinc	

Plant nutrients derived from urea phosphate, potassium chloride, urea, boric acid, sodium molybdate, calcium EDTA, magnesium EDTA, cobalt EDTA, copper EDTA, manganese EDTA and zinc EDTA.

Figure 1. Conceal® and FurrowJet® Placement

Stoller®USA FurrowJet® Study Continued



Results:

Urea Mate applied as a Dual Band Conceal® system treatment resulted in +2.5 Bu/A. yield gains with associated positive net returns of +\$19.05/A. However, the highest yield response in this study consisted of Bio-Forge Advanced and Charge applied in a tri-band FurrowJet® application, resulting in +5.5 Bu/A. yield increases with a positive return on investment of +\$52.36/A.

FurrowJet® and Conceal® combination treatments tallied +5.7 Bu/A. yield gains and net returns of +\$43.86/A.

Planting Date: 4/27 Variety: Asgrow 27XF1 Population: 130K Row Width: 30" Rotation: BAC SB Price: \$11.98

BioForge Advanced: \$8.21/A. Charge: \$5.32/A. Harvest Plus: \$6.21/A Urea Mate: \$2.18/# Sugar Mover: \$9.53/A. XyCyte: \$5.84/A.

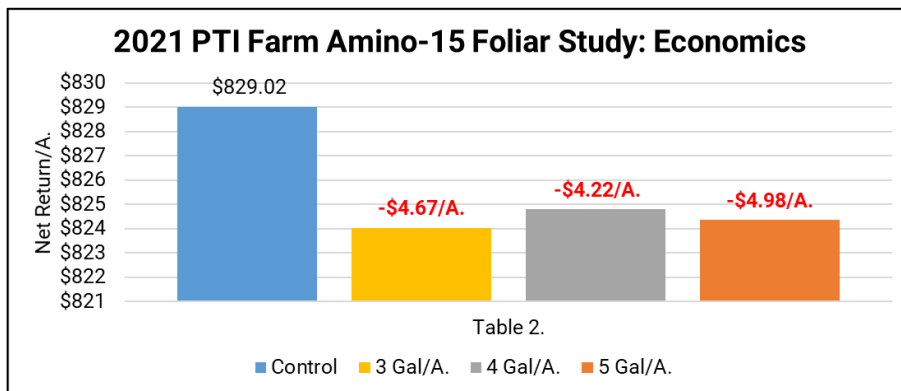
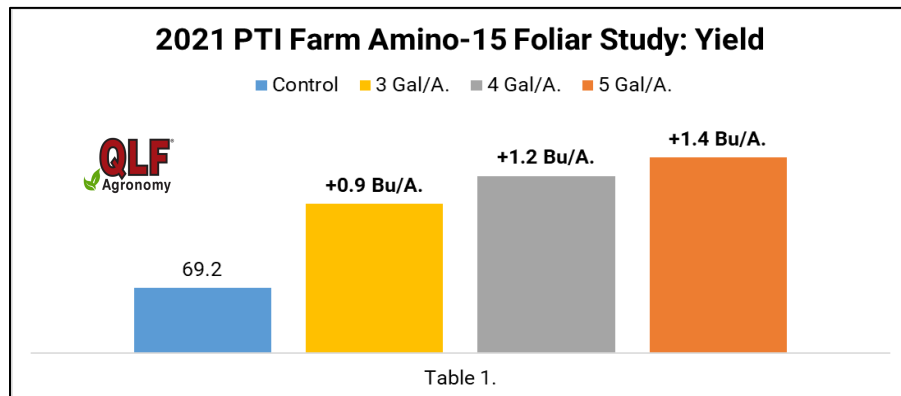
QLF L-CBF Amino 15-0-1 Foliar Study

Objective: To evaluate yield and net return of QLF Agronomy’s Liquid Carbon-Based Fertilizer (L-CBF) Amino 15-0-1 applied foliar at the R3 soybean growth stage.

Amino 15-0-1 is a balanced source of foliar nitrogen with available carbon in a low pH chemistry package. L-CBF Amino 15-0-1 has 10% sugar. For every gallon, a full pound of sugar is delivered in a microscopic form, raw and undegraded, further enhancing the adjuvant characteristics of this liquid fertilizer blend.

Derived from sugar cane molasses with an added fermentation yeast extract for enhanced biological function, and paired with high quality Urea solution and L-Amino Acid forms of nitrogen, L-CBF Amino 15-0-1 is a safer and more efficient approach to foliar nitrogen applications and plant protein formation.

Results: Amino-15 proved yield gains of +0.9 to +1.4 Bu/A., however failed to reach positive economic gain at each application rate.



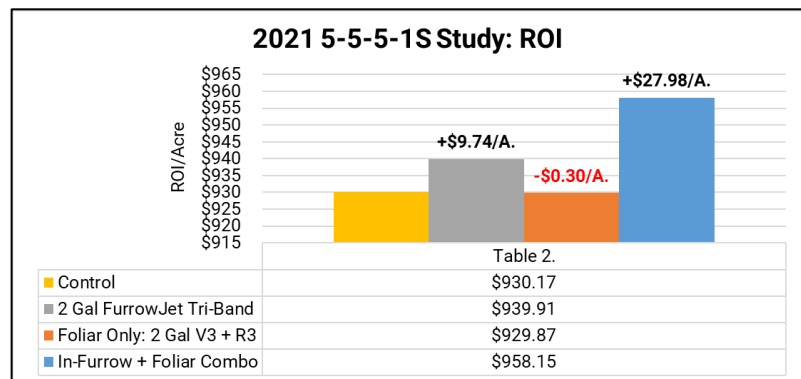
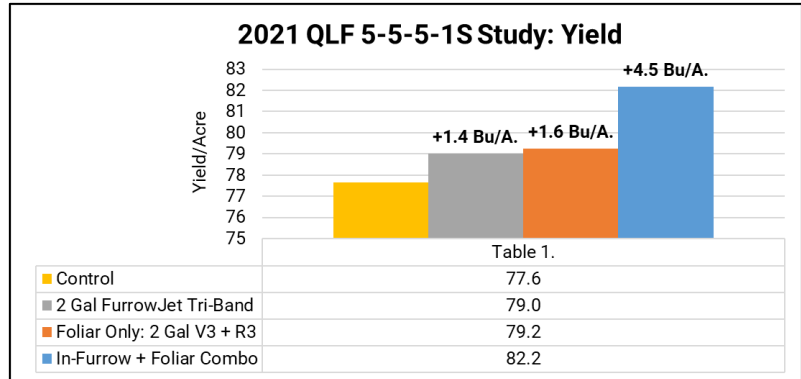
QLF L-CBF 5-5-5-1S Study

Objective: To evaluate yield and net return of QLF Agronomy’s Liquid Carbon-Based Fertilizer (L-CBF) 5-5-5-1S applied in-furrow, and foliar at the V3 and R3 soybean growth stages.

5-5-5-1S is a carbon based balanced source of foliar nitrogen, phosphorous, potassium and sulfur with available carbon in a low pH chemistry package. L-CBF 5-5-5-1S has 20% sugar, which for every gallon over 2# pounds of sugar is delivered in a microscopic form, raw and undegraded, further enhancing the adjuvant characteristics of this liquid fertilizer blend.

Derived from sugar cane molasses with an added fermentation yeast extract for enhanced biological function, and paired with high quality Urea solution and L-Amino Acid forms of nitrogen, L-CBF 5-5-5-1S is a safer and more efficient approach to foliar applications and plant protein formation.

Results: 5-5-5-1S proved positive yield gains of +1.4 to +4.5 Bu/A., however a combination of in-furrow plus foliar treatments proved optimum economic performance with net revenues of +\$27.98/A.



Ocean Blue Ag Fertility High Management Study

Objective: To evaluate the yield and economics of Ocean Blue Ag's soybean nutrition program. This high management fertility study implements the use of pre-plant dry calcium, at-plant FurrowJet® and Conceal® liquid nutrition, as well as foliar liquid applications at V3, VT, and R1 growth stages in a high yield, irrigation corn/soybean rotation.

SandyCa by Calcean is applied as a broadcast pre-plant and is raw natural aragonite sand that is 94-98% pure calcium carbonate.

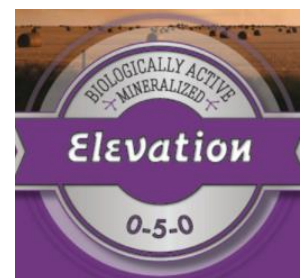
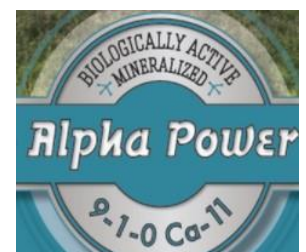
Elevation 0-5-0 is an early V3 foliar feed that contains long lasting bio-stimulated catalyst and phosphoric acid that helps pollination, blossom retention and fruiting.

Grain Gain 0-5-0 is a VT foliar feed that is a reproductive energizer and catalyst that improve test weight, insect and disease resistance and better grain fill.

Nutri-Shield 0-7-0 is applied in-furrow and contains vitamin hormone enzymes, rooting acids, chelated trace minerals, and humic acids. It helps provide for immediate growth energy, promotes stronger roots and suppresses insect feeding.

Alpha Power is a 9-1-0 Ca-11 that contains vitamin hormone enzymes, organic acids, humates, kelp & chelated trace minerals and ocean minerals BENEFITS. It accelerates vegetative growth, and promotes disease suppression.

Hydron is a liquid foliar product made from anhydrous ammonia mixed with water.



Ocean Blue Ag Fertility High Management Study

<u>Program 1.</u>	<u>Application Timing</u>	<u>Placement of Fertilizer</u>
500# Aragonite	Pre-Plant	Broadcast Spinner
80oz NutriShield	At-Plant In-Furrow	FurrowJet® Tri-Band
64oz Elevation	V3	Foliar Broadcast Spray
1 Gal GrainGain	R1	Foliar Broadcast Spray

<u>Program 2.</u>	<u>Application Timing</u>	<u>Placement of Fertilizer</u>
500# Aragonite	Pre-Plant	Broadcast Spinner
160oz NutriShield	At-Plant In-Furrow	FurrowJet® Tri-Band
4 Gal Alpha Power	At-Plant Dual Band	Conceal® Dual Band
64oz Elevation	V3,V8	Foliar Broadcast Spray
1 Gal GrainGain	R1, R3, R5	Foliar Broadcast Spray
64oz Hydron	R1, R3, R5	Foliar Broadcast Spray

The tables above illustrate the protocol of the two programs initiated in this study.

Program 1. Consists of a lower maintenance program with fewer foliar treatments, no Conceal® treatments, and 50% rates of NutriShield.

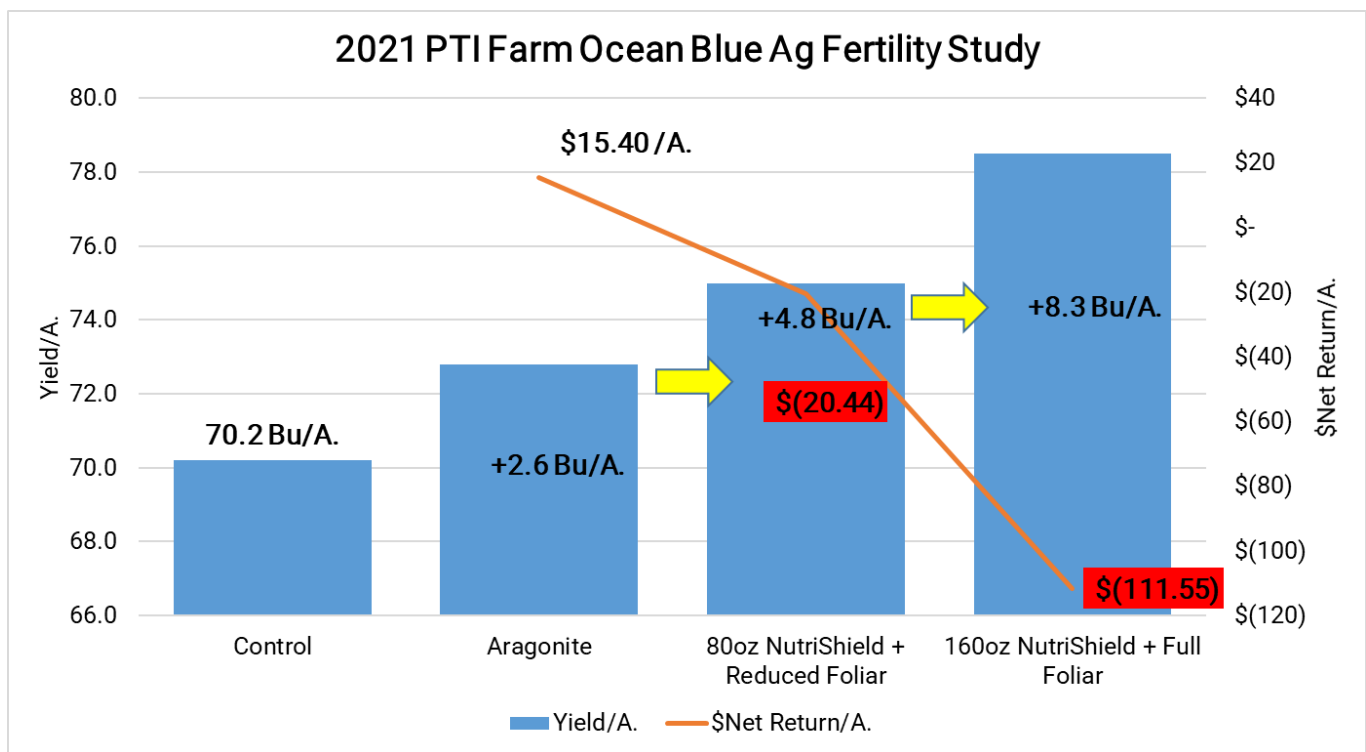
Program 2. Adds additional 80oz of NutriShield in-furrow, adds Conceal® dual band treatments of Alpha Power, and additional foliar treatments at V8, R1, R3 and R5.

Ocean Blue Ag Fertility High Management Study

Results: Aragonite calcium treatments resulted in +2.6 Bu/A. yield gains with a positive return on investment of +\$15.40/A.

80oz of NutriShield and the reduced foliar program also resulted positive yield gains of +4.8 Bu/A., but occurred net economic losses of **-\$20.44/A.**

160oz of of NutriShield and the full foliar program resulted in the largest yield gains in the study at +8.3 Bu/A., but failed to provide economic gains with losses of **-\$111.55/A.**



Planting Date: April 24 Variety: GH 3192XF Population: 130K Row Width: 30" Rotation: BAC SB Price: \$11.98 Pro. #2 App: \$24/A. Pro.#1App:\$12/A.

Aragonite: \$159 + \$6 App NutriShield: \$26.88/Gal Alpha Power: \$8.30/Gal Grain Gain: \$19.95/Gal Elevation: \$26.88/Gal Hydron: \$11.80/Gal

Stoller®USA SB V2 Growth Stage Foliar Application Study


Objective: To evaluate the yield and net return of Stoller®USA 's Bio-Forge®Advanced, Harvest Plus, and X-Cyte all applied foliar at the early V2 growth stage.

X-Cyte is an EPA-registered plant growth regulator and yield stimulant and works to restore hormonal balance, improve carbohydrate storage capacity, and increase cell division in plants for enhanced uniformity, density and quality of fruit grain. X-Cyte™ increases cell division within the plant, helping to increase stem strength and reduce the chances of lodging.




ACTIVE INGREDIENTS:	
Cytokinin, as kinetin, based on biological activity	0.04%
OTHER INGREDIENTS:	99.96%
Total	100.00%
(Contains 0.0064 oz. cytokinin/pint)	
CONTAINS NON-PLANT FOOD INGREDIENTS:	
0.04% Cytokinin	
Information regarding the contents and levels of metals in this product is available on the internet at http://www.aapfco.org/metals.html	

Bio-Forge® Advanced is an abiotic stress mitigator in plants. It does so by facilitating greater uptake and utilization (metabolism) of key nutrients, like nitrogen, from available resources including soil-bound nutrients.



Bio-Forge® Advanced	
3-0-1	
GUARANTEED ANALYSIS	
Total Nitrogen (N)	3%
1.25% Urea Nitrogen	
1.75% Other Water Soluble Nitrogen	
Soluble Potash (K ₂ O)	1%
Cobalt (Co)	1%
1% Chelated Cobalt (Co)	
Molybdenum (Mo)	1%

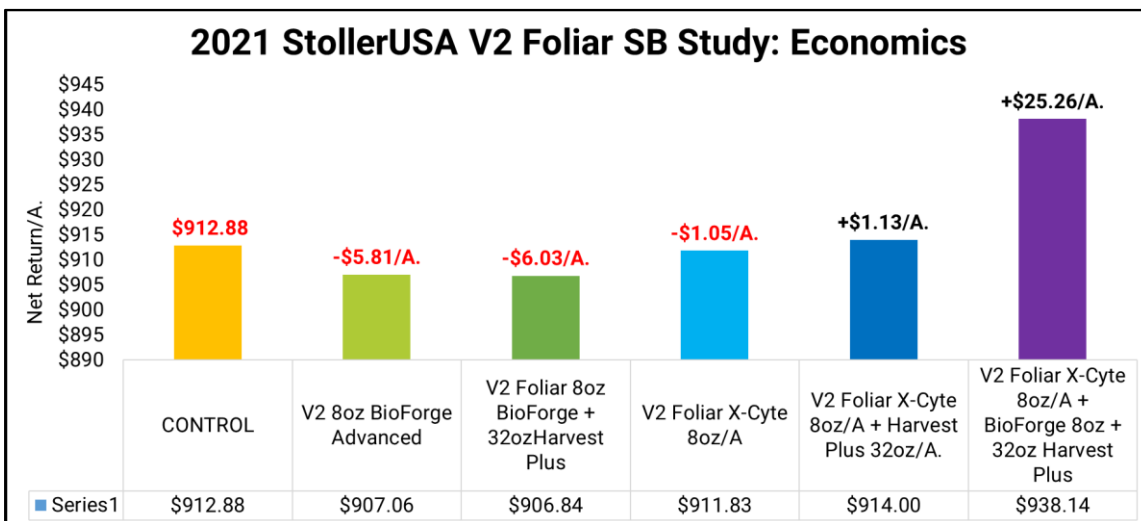
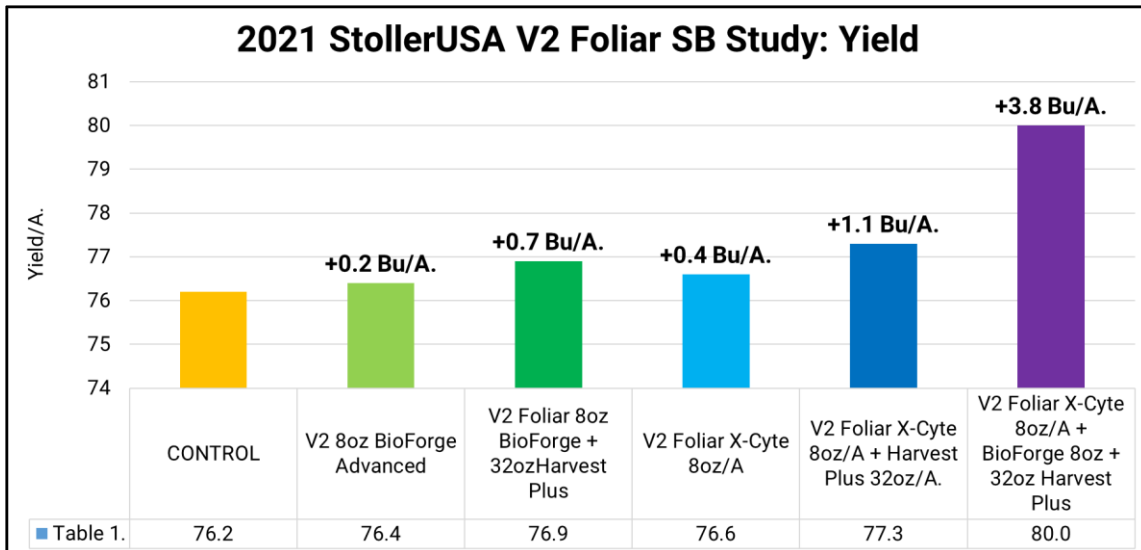
Stoller's Harvest Plus is 8-0-0 premium liquid fertilizer that also contains 3% Sulfur, .25% Boron, 3% Manganese, and 3% Zinc.



Harvest Plus	
8-0-0	
Enhanced Micro Blend	
GUARANTEED ANALYSIS	
Total Nitrogen (N)	8%
8% Ammoniacal Nitrogen (N)	
Sulfur (S)	3%
3% Combined Sulfur (S)	
Boron (B)	0.25%
Manganese (Mn)	3%
3% Chelated Manganese (Mn)	
Zinc (Zn)	3%
3% Chelated Zinc (Zn)	
Derived from aqueous ammonia, boric acid, manganese sulfate and zinc sulfate chelated with citric acid	

Stoller®USA SB V2 Growth Stage Foliar Application Study Continued

Results: The combination treatment of all products resulted in gains of +3.8 Bu/A. with positive net returns of +\$25.26/A. However, all other treatments responded with likewise yield gains of +0.2 to 1.1 Bu/A., but all tallied net economic losses ranging from **-\$1.05/A.** to **-\$6.03/A.**



Planting Date: 4/28 Variety: AG 27XF1 Population: 130K Row Width: 30" Rotation: BAC Soybean Price: \$11.98

Bio-Forge Advanced: \$8.21/A.

Harvest Plus: \$6.21/A.

X-Cyte: \$5.84/A.

Stoller®USA SB R3 Growth Stage Foliar Application Study

Objective: To evaluate the yield and net return of Stoller®USA 's Bio-Forge®Advanced, Harvest More Urea Mate, and Sugar Mover Premier all applied foliar at the R3 growth stage.

Bio-Forge® Advanced is an abiotic stress mitigator in plants. It does so by facilitating greater uptake and utilization (metabolism) of key nutrients, like nitrogen, from available resources including soil-bound nutrients.

Bio-Forge® Advanced	
3-0-1	
GUARANTEED ANALYSIS	
Total Nitrogen (N).....	3%
1.25% Urea Nitrogen	
1.75% Other Water Soluble Nitrogen	
Soluble Potash (K ₂ O).....	1%
Cobalt (Co).....	1%
1% Chelated Cobalt (Co)	
Molybdenum (Mo).....	1%

HARVEST MORE™ UREA MATE 5-10-27 is a complete fertilizer with both macro and micronutrients in a readily available water-soluble acidic formulation. Harvest Plus is 8-0-0 premium liquid fertilizer that also contains 3% Sulfur, .25% Boron, 3% Manganese, and 3% Zinc.

HARVEST MORE™ UREA MATE 5-10-27



GUARANTEED ANALYSIS	
Total Nitrogen (N)	5%
5% Urea Nitrogen	
Available Phosphate (P ₂ O ₅).....	10%
Soluble Potash (K ₂ O).....	27%
Calcium (Ca).....	4%
4% Chelated Calcium	
Magnesium (Mg).....	1.5%
1.5% Chelated Magnesium	
Boron (B).....	0.15%
Cobalt (Co).....	0.008%
0.008% Chelated Cobalt	
Copper (Cu).....	0.3%
0.3% Chelated Copper	
Manganese (Mn).....	0.5%
0.5% Chelated Manganese	
Molybdenum (Mo).....	0.008%
Zinc (Zn).....	0.5%
0.5% Chelated Zinc	

Plant nutrients derived from urea phosphate, potassium chloride, urea, boric acid, sodium molybdate, calcium EDTA, magnesium EDTA, cobalt EDTA, copper EDTA, manganese EDTA and zinc EDTA.

Sugar Mover Premier is an EPA registered plant growth regulator and yield stimulant that increases the rate of sugar transport from leaves to flowers, ears, seeds, pods, and root storage tissue to increase available sugar and seed size for higher yield.

SUGAR MOVER PREMIER™

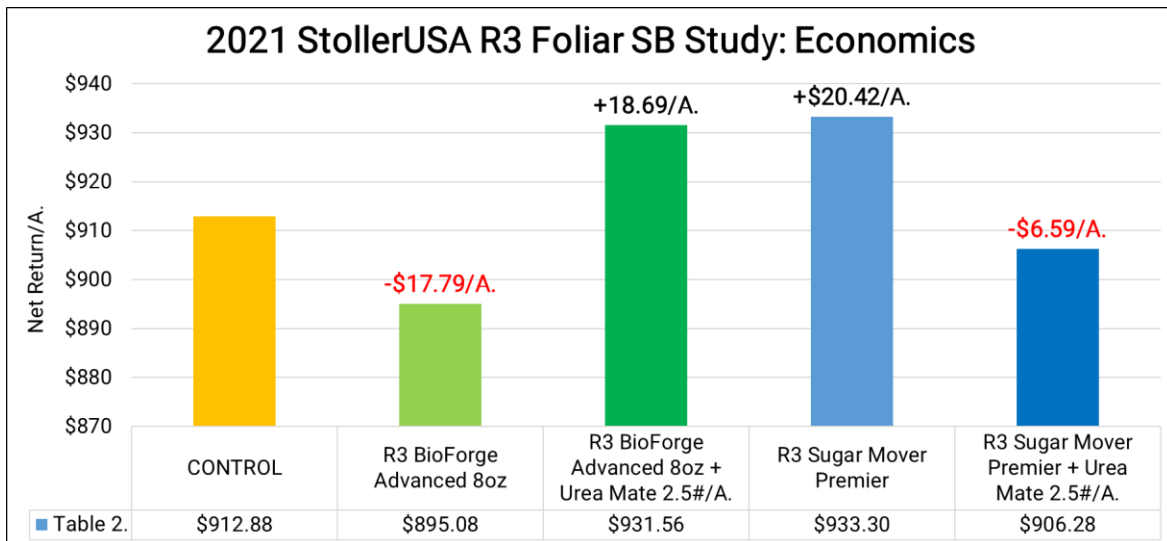
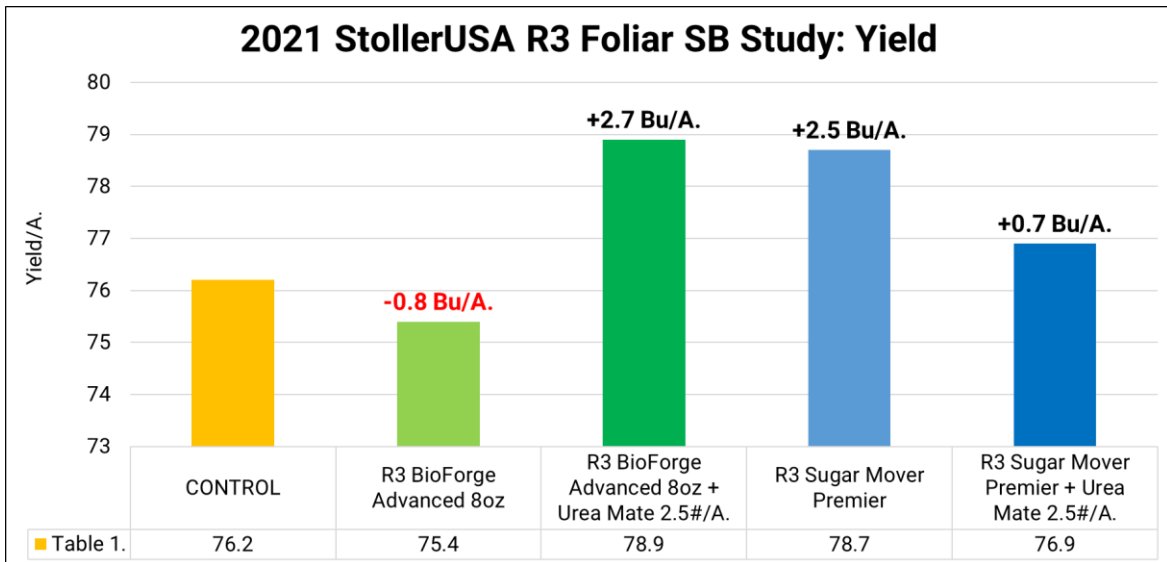


ACTIVE INGREDIENTS:	
Cytokinin, as kinetin, based on biological activity.....	0.003%
INERT INGREDIENTS	99.997%
TOTAL	100.00%

(Contains approx. 0.018g Cytokinin/pint)
CONTAINS NON-PLANT FOOD INGREDIENT: 0.003% Cytokinin

Stoller®USA SB R3 Growth Stage Foliar Application Study

Results: BioForge/Urea Mate tankmixes as well as Sugar Mover treatments tallied economic positive gains at +\$18.69/A. and +\$20.42/A. respectively. Individual treatments of BioForge and Sugar Mover/Urea Mate tankmixes resulted in economic losses of **-\$17.79/A.** and **-\$6.59/A.**



Planting Date: 4/28 Variety: AG 27XF1 Population: 130K Row Width: 30" Rotation: BAC Soybean Price: \$11.98

Bio-Forge Advanced: \$8.21/A.

Harvest More Urea Mate: \$2.18/#

Sugar Mover: \$9.53/A.

Revytek™ Soybean Foliar Fungicide Study

Objective: To evaluate the yield and net return of a new triazole soybean fungicide introduced in 2020 called Revytek™. Revytek contains Revysol, which is a DeMethylation Inhibitor (DMI) fungicide that is part of the triazole group of fungicides. It was initially labeled for 17 crops, including corn and soybeans. Revytek gives excellent control of frogeye leaf spot, septoria, target spot, and Asian soybean rust.

Mefentrifluconazole	Group	3	Fungicide
Fluxapyroxad	Group	7	Fungicide
Pyraclostrobin	Group	11	Fungicide

Results: Tables 1 illustrates foliar applications of Revytek™ resulted in yield gains of +6.5 Bu/A. at R1 and +6.1 Bu/A. at R3 growth stage applications. Combo R1/R3 resulted in +10.0 Bu/A. yield response.

After cost of application and fungicide, Revytek proved positive net returns of +\$47.78, +\$43.48, and +\$59.80 respectively (Table 2).



Revytek™

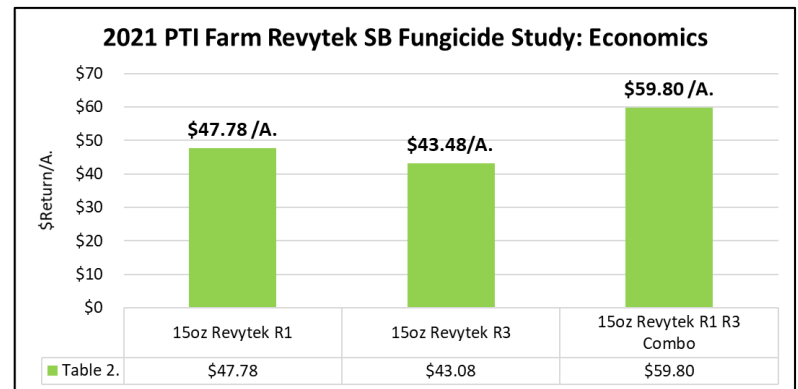
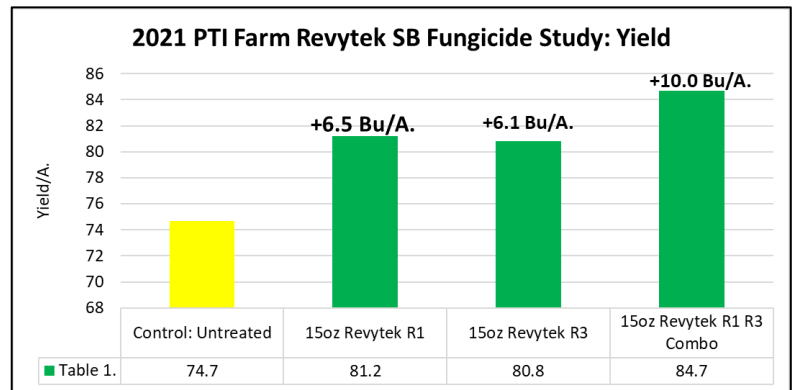
Fungicide

BASF
We create chemistry

Active Ingredients*:

mefentrifluconazole: 2-[4-(4-chlorophenoxy)-2-(trifluoromethyl)phenyl]-1-(1H-1,2,4-triazole-1-yl)propan-2-ol	11.61%
pyraclostrobin: (carbamic acid, [2-[[[1-(4-chlorophenyl)-1H-pyrazol-3-yl]oxy]methyl]phenyl]methoxy-, methyl ester)	15.49%
fluxapyroxad: 1H-Pyrazole-4-carboxamide, 3-(difluoromethyl)-1-methyl-N-(3',4',5'-trifluoro[1,1'-biphenyl]-2-yl)-	7.74%
Other Ingredients:	65.16%
Total:	100.00%

*Revytek™ fungicide contains 1.11 lbs mefentrifluconazole, 1.48 lbs pyraclostrobin, and 0.74 lb fluxapyroxad per gallon.



Miravis® Neo™ Soybean Foliar Fungicide Study



Objective: To evaluate the yield and economics of a Miravis® Neo™ in soybeans.



Miravis Neo fungicide combines propiconazole, azoxystrobin and Adepidyn technology – one of the most powerful, broad spectrum SDHI molecules available, and delivers superior plant-health benefits and improved preventive and curative control of key such as Brown Spot, Pod and Stem Blight, Frogeye Leaf Spot, Anthracnose, Powdery Mildew and White Mold (suppression).

ADEPIDYN® Technology*

Active Ingredients:

Pydiflumetofen**	7.0%
Azoxystrobin***	9.3%
Propiconazole****	11.6%

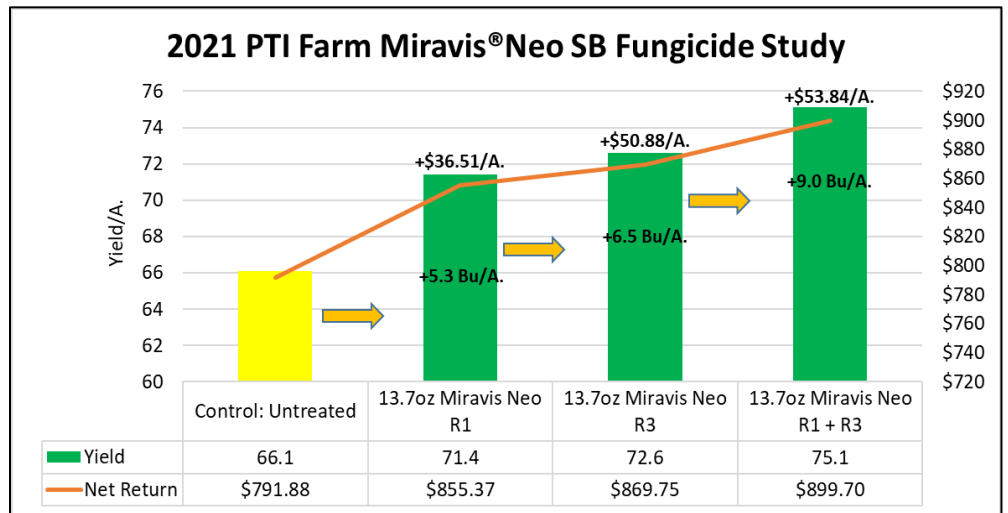
Other Ingredients:	72.1%
Total:	100.0%

PYDIFLUMETOFEN	GROUP	7	FUNGICIDE
PROPICONAZOLE	GROUP	3	FUNGICIDE
AZOXYSTROBIN	GROUP	11	FUNGICIDE



Results: Foliar applications of MiravisNeo at both R1 and R3 resulted in highest yields at +9.0 Bu/A. and economic return at +\$63.84/A.

Both R1 and R3 individual treatments resulted in similar yield gain at +5.3 Bu/A. and +6.5 Bu/A. with both at positive economic gains of +\$36.51 to +\$50.88/A.



Calcium Products SO4™ Study

Objective: This trial evaluates the yield response and economics of pelletized calcium sulfate (SO4) applied fall broadcast and as banded spring strip-till. Sulfur is an essential component of plant growth with key processes relying on chlorophyll formation and protein production. Sulfur is considered the fourth major nutrient behind N, P, and K.



SO4 from Calcium Products is a 21% Calcium (non-pH neutralizing) and 17% Sulfur dry pelletized fertilizer and is mined and manufactured in NW Iowa. It is finely ground and pelletized to achieve a balance of solubility and pellet strength.

Historically, much of the sulfur need was satisfied with atmospheric deposition as result of coal burning industries. Amendments to the Clean Air Act in 1990 targeted sulfur emissions, resulting in less than ½ of the amount of sulfur today compared to 30 years ago.

Results: Fall 2020 strip-till treatments of SO4 resulted in average yield gains of +4.9 Bu/A. and positive net returns of +\$37.65/A.

Multi-year data from 2019-2021 have proven yield gains of +4.6, +2.6 and +4.9 respectively.

We look forward to continuing our long-term multi-year testing of SO4 and understanding its benefits of supplying plant nutrition, but also its effect on soil health advantages.

Releases Sulfur to Match Plant Needs

SO4 supplies a balanced initial sulfur release and a steady supply throughout the growing season. AMS releases sulfur too quickly, and elemental sulfur releases sulfur too slowly, neither meeting the crop's complete needs.

Spreads Easily

SO4's consistent pellet size allows it to be blended and applied with other dry fertilizers, which means it doesn't require a separate application. It can be applied pre-plant in the spring, in-season via top dress or post-harvest in the fall.

Will Not Acidify Soil

SO4 is pH neutral, meaning it will not acidify the soil like other sulfur sources. Proper soil pH maximizes a plant's utilization of nutrients promoting good plant health and optimizing yield.

2021 PTI Farm SO4 Study: Yield

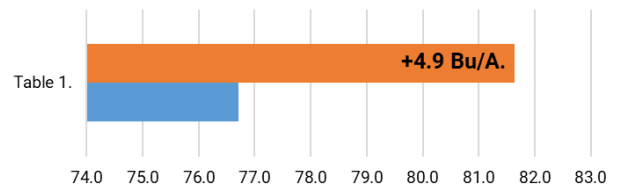


	Table 1.
150# SO4 Fall Strip-Till 2020	81.6
Control	76.7

Yield / A.

2021 PTI Farm SO4 Study: Economics

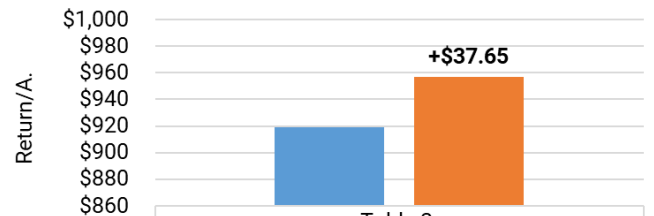


	Table 2.
Control	\$918.96
150# SO4 Fall Strip-Till 2020	\$956.61

Marco Fertilizer NutriStart BOOST 14-12-4-6S Study

Objective: This trial evaluates the yield and net return of Conceal® system dual band treatments of NutriStart™ BOOST 14-12-12-4-6S at 10, 15, and 20 Gal/A. rates. This liquid fertilizer is a 70% polyphosphate and 30% orthophosphate formula designed for non-in furrow applications in soybeans. NutriStart products are manufactured with Marco 10-34-0, Potassium - soluble potash (K2O), Sulfur - Ammonium Thio-Sulfate and Zinc - 9% EDTA.



Conceal® system is an ideal placement for this product as its far enough away from the seed furrow to prevent seed injury, yet close enough to enable access to seedling nutrition (Figure 1).

Results: Table 1. illustrates that all rates of 14-12-4-6S proved positive yield gains from +3.4 to +5.0 Bu/A., however 15 Gal/A. provided the economic optimum rate applied resulting in a positive return on investment of +\$53.15/A.

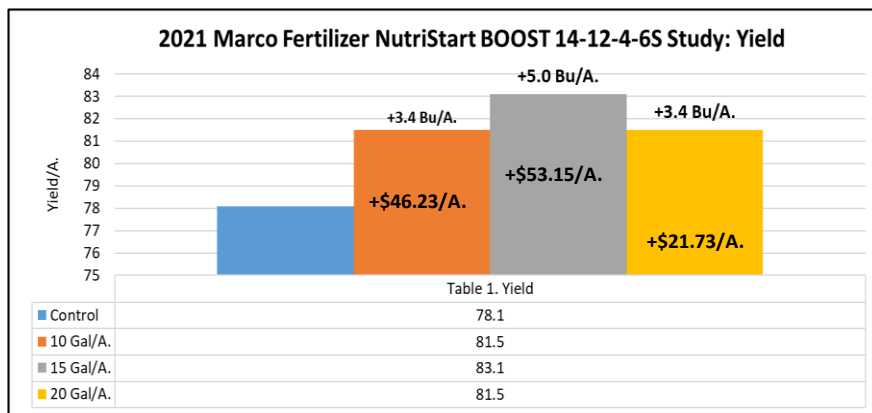


Table 2. reveals long-term multi-year economics during 2018-2021. Over this 4-year period, economic optimum has occurred at the 10 Gal/A. rate of NutriStart BOOST with an average return on investment of +\$46.34/A. NutriStart BOOST has been a solid performer at the PTI farm achieving some of the highest yield and economic gains in soybeans.

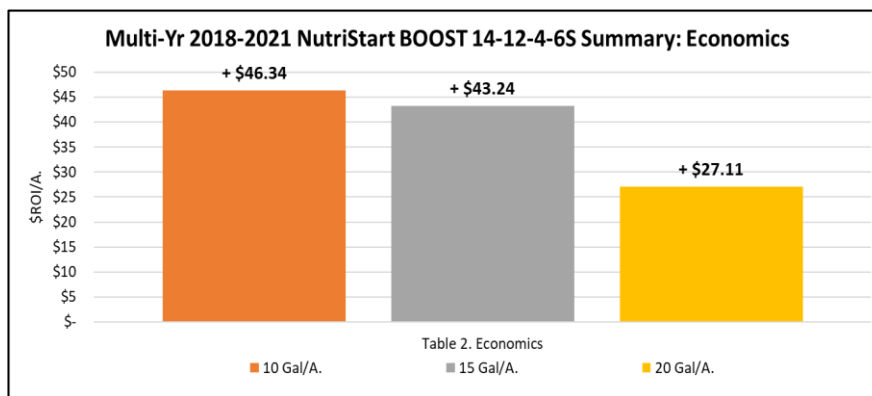


Figure 1. Conceal® Dual Placement 3"



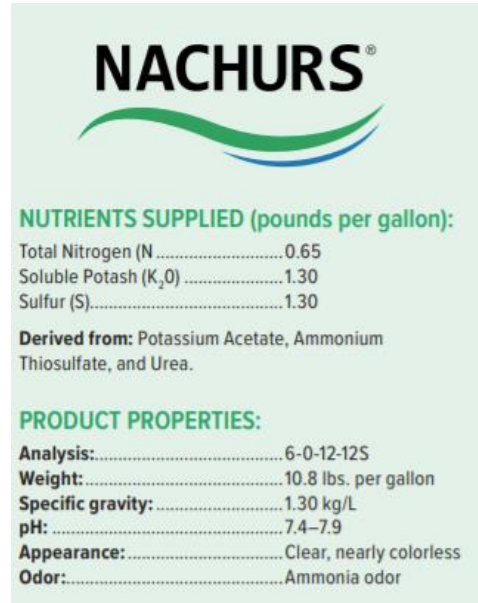
K-Fuse® Potassium Study

Objective: To evaluate the yield and economics of Nachurs K-Fuse powered by Bio-K (Figure 1.), a 6-0-12-12S potassium/sulfur product designed to be applied on the planter or at side-dress. For this study we applied one, three, and five gallons of K-Fuse at planting in a dual band Conceal® system application (Figure 2.).

Results: Tables 1-2. illustrate dual band K-Fuse Conceal® system applications proved yield increases of +1.3 to +2.9 Bu/A. with the 3 Gal/A. rate economic optimum rate/A.

Table 3. shows average economic response of K-Fuse in soybeans during both the 2019 to 2021 crop years with positive return on investment with all rates. However, 3 Gal/A. rates have provided the economic optimum rate.

Figure 1. Nachurs K-Fuse® Potassium Additive



NACHURS®

NUTRIENTS SUPPLIED (pounds per gallon):
 Total Nitrogen (N) 0.65
 Soluble Potash (K₂O) 1.30
 Sulfur (S)..... 1.30

Derived from: Potassium Acetate, Ammonium Thiosulfate, and Urea.

PRODUCT PROPERTIES:
Analysis:..... 6-0-12-12S
Weight:..... 10.8 lbs. per gallon
Specific gravity:..... 1.30 kg/L
pH: 7.4–7.9
Appearance:..... Clear, nearly colorless
Odor:..... Ammonia odor

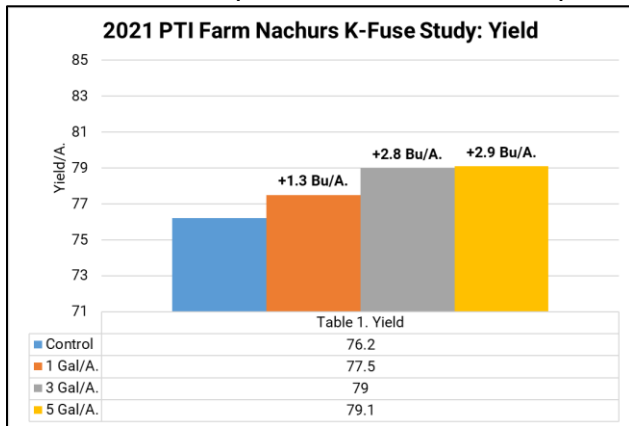
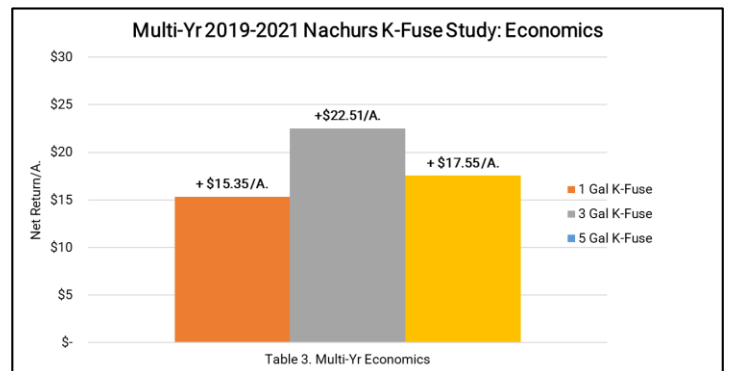
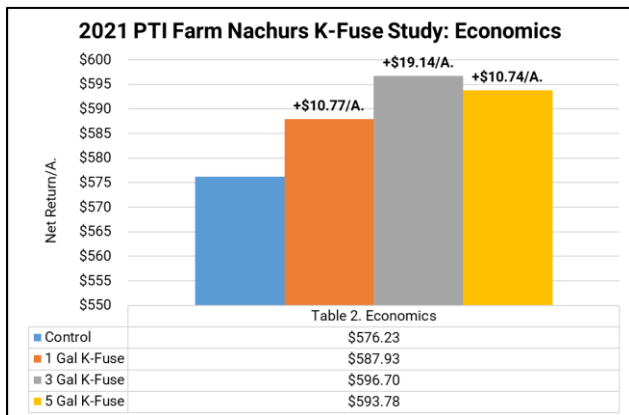


Figure 2. Conceal® Dual Placement 3" from Seed Furrow, 1.5" in Depth



L-CBF 7-21-3 MKP FurrowJet® Study

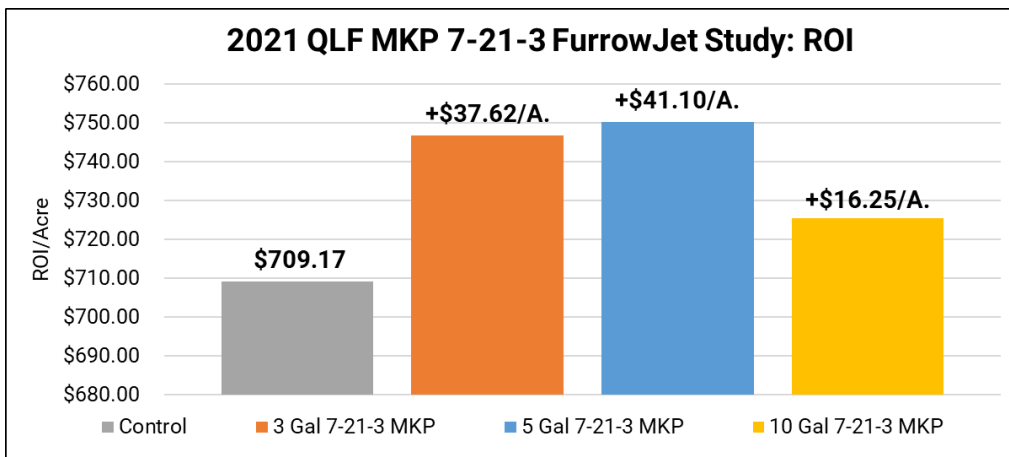
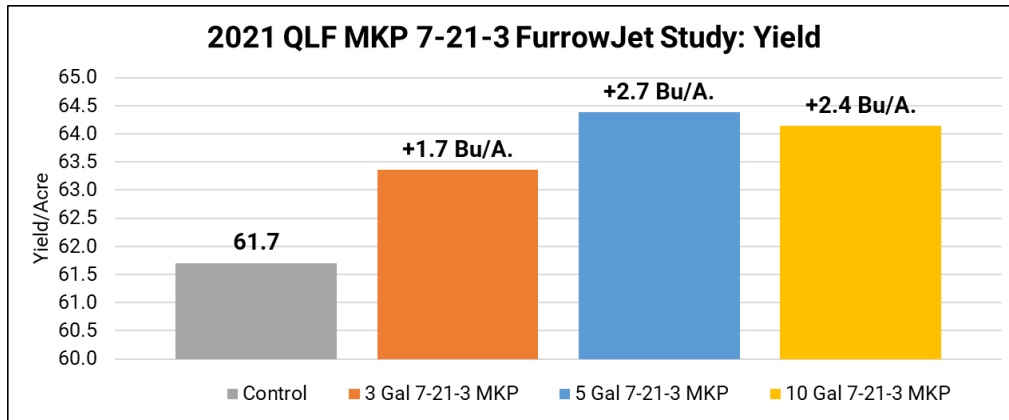
Objective: To evaluate yield and net return of QLF Agronomy’s Liquid Carbon-Based Fertilizer (L-CBF) starter 7-21-3 MKP applied through FurrowJet® Wings (Figure 1).

Figure 1. FurrowJet® Wing Application



L-CBF 7-21-3 is a liquid starter blend derived from premium orthophosphate MKP (monopotassium phosphate) for plant available phosphorus, available carbon from sugar cane molasses as an energy source for soil microbes and enhanced biological function with an added fermentation yeast extract.

Results: L-CBF 7-21-3 treatments resulted in yield gains of +1.7 Bu/A. to +2.7 Bu/A., with the 5 Gal/A. rate providing agronomic optimum rate. 5 Gal/A. also proved economic optimum rate with positive returns of +\$40.81/A.



Planting Date: 5/19

Variety: Asgrow 35XF1

Population: 130K

Row Width: 30"

Rotation: BAC

Bean Price: \$11.98

7-21-3: \$4.25/Gal.

Fertilizer Reallocation: \$30

L-CBF Boost 4-0-3-2S Conceal® Study

Objective: To evaluate yield and net return of QLF Agronomy’s Liquid Carbon-Based Fertilizer (L-CBF) BOOST 4-0-3-2S applied through a dual band Conceal® system application (Figure 1.)

BOOST is a concentrated source of available carbon in a low pH chemistry package, L-CBF BOOST 4-0-3-2S enhances soil biology creating more plant available nutrients.

Derived from sugar cane molasses (30% sugar) with an added fermentation yeast extract for enhanced biological function, and paired with non-protein nitrogen, sulfate sulfur, and strong acids, L-CBF BOOST 4-0-3-2S is not only an added energy source for soil microbes, but also a safer approach to improving fertilizer performance.

Results: L-CBF BOOST treatments resulted in yield gains of +0.5 Bu/A. to +1.0 Bu/A. with 2 Gal/A. rates of BOOST providing economic optimum rate with positive revenue gains of +\$5.09/A.

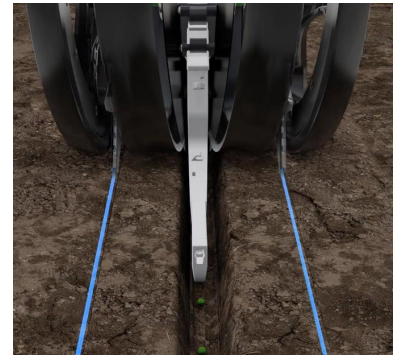
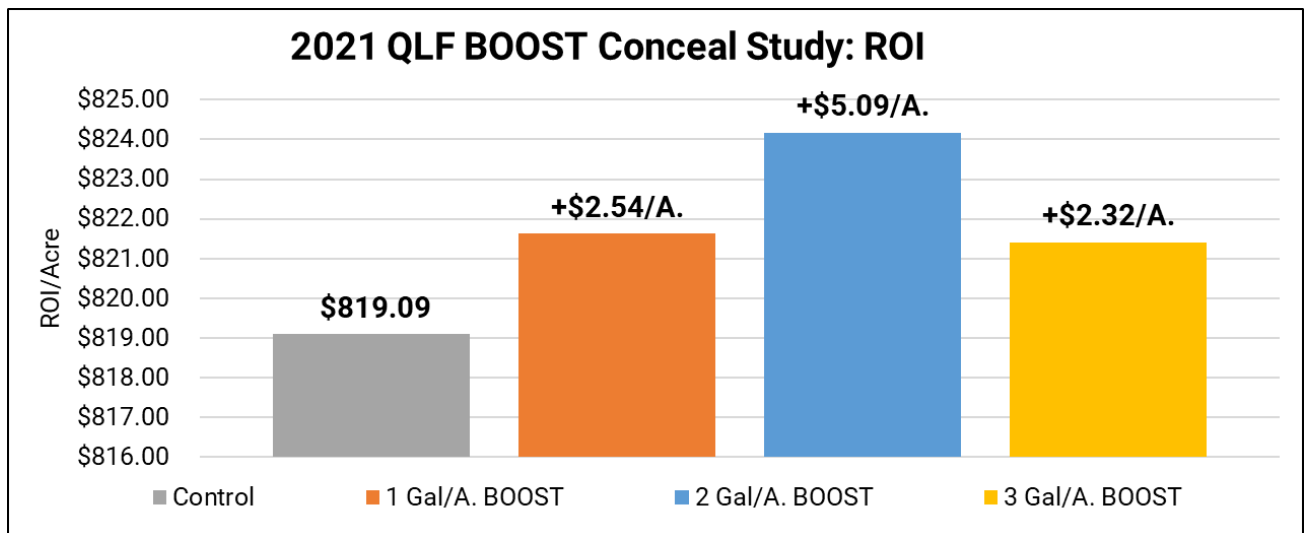
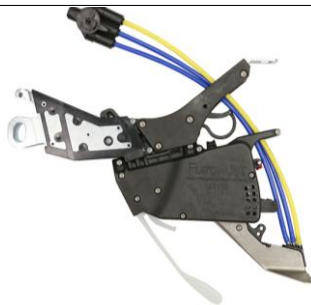


Figure 1. Conceal® placement 3” away from seed furrow and 1.5” deep



Soybeans Summary of 2021 FurrowJet® Applications

	Classification	Yield (Bu/A.)	\$ROI	Page #
Irrigated 30" Soybeans	Irrigated	24.4	\$ 292.31	187
Soybean High Management FJ Wings	Fertility	6.8	\$ 97.24	181-183
Soybean High Management FJ Center	Fertility	6	\$ 84.06	181-183
Soybean Marco Quickgrow LTE 8Gal	Fertility	6.2	\$ 74.28	222
Soybean Nachurs Start 2 Finish At-Plant + R1 Foliar + R3 Foliar	Fertility +Foliar	8.4	\$ 69.97	224
Soybean High Management Conceal + 3-way Combo	Fertility	13.6	\$ 68.41	181-183
Soybean Nachurs Start 2 Finish At-Plant + R1 Foliar	Fertility +Foliar	6.8	\$ 66.70	224
Soybean StollerUSA FJ 3-Way 8oz BioForge Advanced + 32oz Charge 12%	Micronutrient +Biological	5.5	\$ 52.36	226-227
Soybean Marco Quickgrow LTE 4Gal	Fertility	3	\$ 50.94	222
Soybean Marco Quickgrow LTE 6Gal	Fertility	3.5	\$ 49.43	222
Soybeans Nachurs Start 2 Finish At-Plant Only	Fertility		\$ 46.60	224
Soybean StollerUSA Conceal + FurrowJet 5 Point Touch	Fertility	5.7	\$ 43.86	226-227
Soybean Agroliquid FJ Fertility Program	Fertility	3.8	\$ 25.99	225
Soybean FurrowJet Side Wall	Mechanical	1.1	\$ 13.18	175
Soybean Marco Quickgrow LTE 6Gal + 1qt BioMarc	Fertility +Biological	0.9	\$ 10.44	223
Soybean Plant Date April 6 w/Starter	Planting Date +Fertility	3	\$ 9.12	164-165
Soybean Plant Date May 22 w/Starter	Planting Date +Fertility	2.2	\$ (0.46)	164-165
Soybean Marco Quickgrow LTE 4Gal + 1qt BioMarc	Fertility +Biological	0.3	\$ (3.38)	223
Soybean Plant Date April 19 w/Starter	Planting Date +Fertility	1.9	\$ (4.06)	164-165
Soybean Marco Quickgrow LTE 8Gal + 1qt BioMarc	Fertility +Biological	0.1	\$ (5.99)	223
Soybean Plant Date June 17 w/Starter	Planting Date +Fertility	0.6	\$ (19.63)	164-165
Soybean Ocean Blue: 80oz Nutrishield + Reduced Foliar	Fertility +Foliar	4.8	\$ (20.44)	230-232
June 4th SB Plant Date w/Starter	Starter Fertilizer	0.3	\$ (23.23)	164-165
Soybean Ocean Blue: 160oz Nutrishield + Full Foliar	Fertility +Foliar	8.3	\$ (111.50)	230-233
Average		5.1	\$ 36.09	



Soybeans Summary of 2021 Conceal® Applications

	Classification	Yield (Bu/A.)	\$ROI	Page #
Soybean High Management Conceal	Irrigated Fertility	11.5	\$ 82.22	181-183
Soybean Nachurs Start 2 Finish At-Plant + R1 Foliar + R3 Foliar	Potassium	8.4	\$ 69.97	224
Soybean High Management Conceal + FurrowJet 5 Point Touch	Irrigated Fertility	13.6	\$ 76.28	181-183
Soybean Nachurs Start 2 Finish At-Plant + R1 Foliar	Potassium	6.8	\$ 66.70	224
Soybean Marco NutriStart BOOST 14-12-4-6S: 15Gal	Fertility	5	\$ 53.15	240
Soybean Nachurs Start 2 Finish At-Plant Only	Potassium		\$ 46.60	224
Soybean Marco NutriStart BOOST 14-12-4-6S: 10Gal	Fertility	3.4	\$ 46.23	240
Soybean StollerUSA Conceal + FurrowJet 5 Point Touch	Fertility	5.7	\$ 43.86	226-227
Soybean Marco NutriStart BOOST 14-12-4-6S: 20Gal	Fertility	3.4	\$ 21.73	240
Soybean StollerUSA Conceal 5# Urea Mate	Nitrogen	2.5	\$ 19.05	226-227
Soybean K-Fuse Conceal: 1Gal	Potassium	1.3	\$ 10.77	241
Soybean K-Fuse Conceal: 5Gal	Potassium	2.9	\$ 10.74	241
Soybean Boost 4-0-3-2S Conceal: 2Gal	Carbon Based Sugar + S		\$ 5.09	243
Soybean Boost 4-0-3-2S Conceal: 1Gal	Carbon Based Sugar + S		\$ 2.54	243
Soybean Boost 4-0-3-2S Conceal: 3Gal	Carbon Based Sugar + S		\$ 2.32	243
Soybean Plant Date May 22 w/Starter	Starter Fertility + Potassium + S	2.2	\$ (0.46)	164-165
Soybean Plant Date April 19 w/Starter	Starter Fertility + Potassium + S	1.9	\$ (4.06)	164-165
Soybean Plant Date June 17 w/Starter	Starter Fertility + Potassium + S	0.6	\$ (19.63)	164-165
Soybean Plant Date June 4th w/Starter	Starter Fertility + Potassium + S	0.3	\$ (23.23)	164-165
Average		4.6	\$ 26.84	

Soybean Tillage Study

Objective: To evaluate the yield and economic impacts of various tillage programs in a soybean after corn rotation. Tillage programs include strip-till, vertical till, and no-till.

Table 1. University of IL Machinery Cost Estimates

Tillage Practice	Category	Cost
Conventional Till	Ripper	\$ 27.70
	Soil Finisher	\$ 13.60
	Plant	\$ 17.20
	Total:	\$ 58.50
Strip Till	Strip	\$ 17.30
	Burndown	\$ 8.00
	Plant	\$ 17.20
	Total:	\$ 42.50
Vertical Till	Vertical	\$ 13.20
	Burndown	\$ 8.00
	Plant	\$ 17.20
	Total:	\$ 38.40
No Till	Burndown	\$ 8.00
	Plant	\$ 19.00
	Total:	\$ 27.00

Figure 1. Sunflower® 6833 Vertical Tillage Tool



Figure 2. Planting in No-Till



Figure 3. Sunflower 4630 Disc Ripper

Figure 4. Kuhn® Krause Gladiator



Soybean Tillage Study Continued

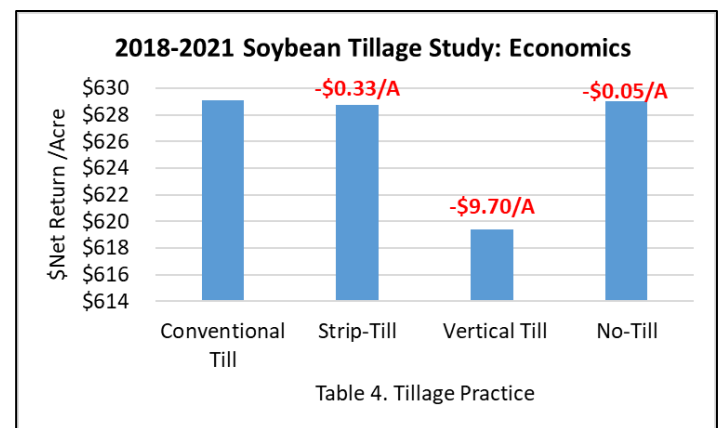
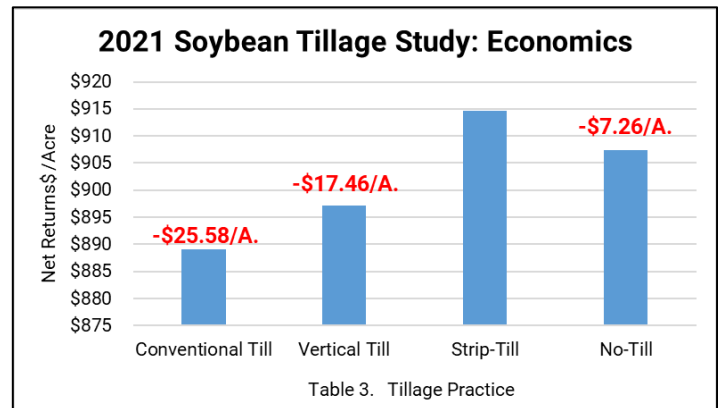
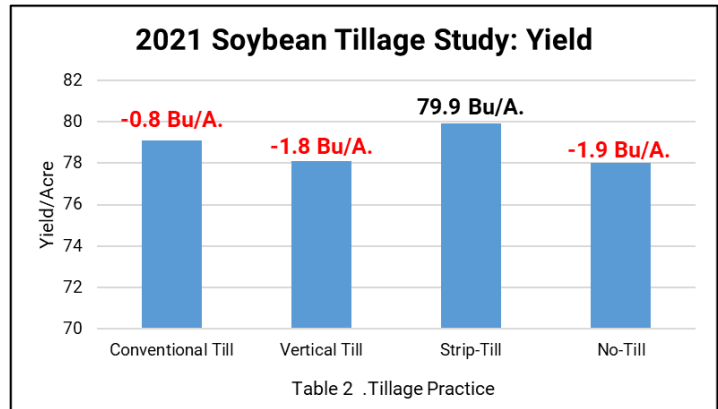
Results: To understand both yield and economics, the University of Illinois Machinery Cost Estimate Summary is used to calculate individual cost of each tillage program (Table 1). For the three reduced tillage programs, an \$8/A. burn-down is also included.

Table 2. illustrates the overall yield for each tillage segment. The yields varied only 1.9 Bu/A. between all tillage programs with strip-till offering the highest yields of 79.9 Bu/A.

After applying all appropriate costs to each individual tillage segment, strip-till offered the highest overall revenue in this tillage system study in 2021. Compared to strip-till, no-till offered losses of **-\$7.26/A.**, vertical tillage **-\$17.46/A.** and due to higher equipment cost, conventional tillage with the highest losses of **-\$25.58/A.** (Table 3.)

Table 4. illustrates multi-year data from the PTI Farm over the time period of 2018-2021. Conventional tillage over this time frame

has provided the highest overall net returns, but no-till and strip-till are with-in **-\$0.05** and **-\$0.33/A.** respectively. Vertical tillage has been the one tillage program that has consistently proved lower returns/acre of **-\$9.70/A.**



Soybean Tillage Study

Objective: To evaluate the yield and economic benefit of implementing a vertical tillage (Figure 1.) in corn stalks before a fall strip-till application (Figure 2.) to aid stalk decomposition.

Results: Vertical tillage made pre-strip-till did not contribute positively to yield or economic gain. In fact, yield was -0.9 Bu/A. lower with net economic losses of **-\$24.21/A.**

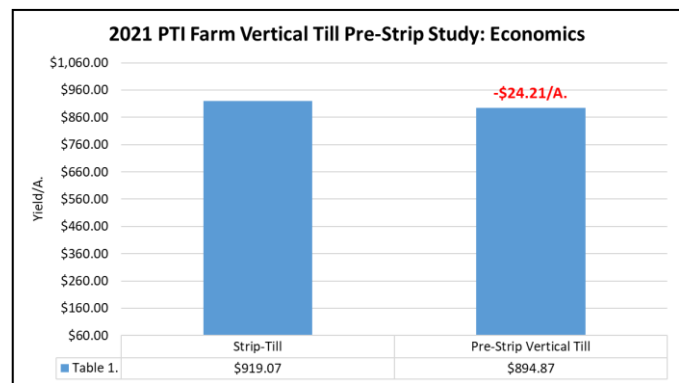
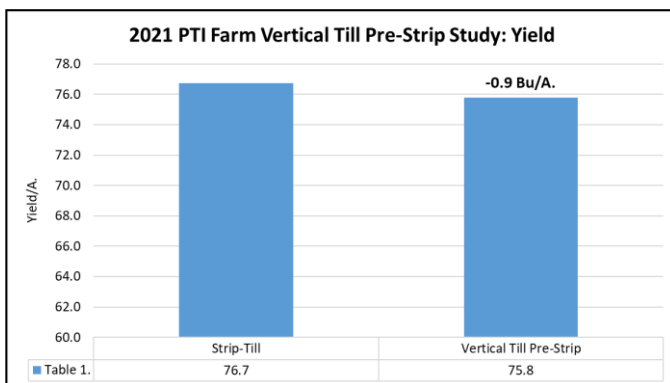
Tillage Practice	Category	Cost
Conventional Till	Ripper	\$ 27.70
	Soil Finisher	\$ 13.60
	Plant	\$ 17.20
	Total:	\$ 58.50
Strip Till	Strip	\$ 17.30
	Burndown	\$ 8.00
	Plant	\$ 17.20
	Total:	\$ 42.50
Vertical Till	Vertical	\$ 13.20
	Burndown	\$ 8.00
	Plant	\$ 17.20
	Total:	\$ 38.40
No Till	Burndown	\$ 8.00
	Plant	\$ 19.00
	Total:	\$ 27.00



Figure 2. Kuhn® Krause Gladiator



Figure 1. Sunflower® 6833 Vertical Tillage Before Strip-Till



Planting Depth Study

Objective: To evaluate yield and economic performance of various soybean planting depths consisting of 1" to 2.75" in ¼" increments.

Results: Tables 1-2. illustrate that the optimum planting depth for this study was 1.75". As planting depth was shallowed up to 1.5", yield was reduced by **-1.3 Bu/A.**, and more importantly suffered economic losses over **-\$15.57/A.** Further yield decline occurred at the shallowest depths of 1.25" and 1", with yield deficits of **-2.9 Bu/A.** and **-5.3 Bu/A.**, and significant economic losses ranging from **-\$34 to -63/A.**

As planting depth was increased to 2.0", a minimal yield loss of **-0.3 Bu/A.** occurred, resulting in lower economic returns by only **-\$3.59/A.** As planting depths went deeper to 2.25", yields fell by **-1.2 Bu/A.** and suffered economic losses of **-\$14.38/A.** Continuing to push planting depths deeper to 2.5" to 2.75" proved the highest losses in the study at **-6.5 to -6.9 Bu/A.** with corresponding losses of **-\$77 to 82/A.**

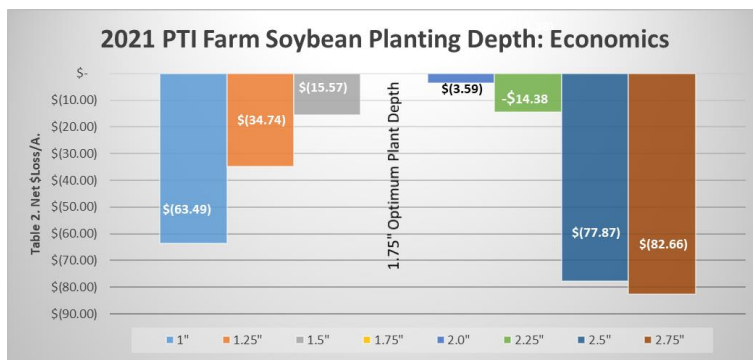
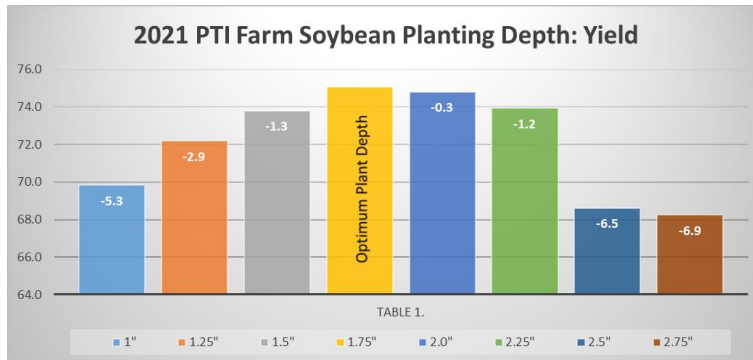


Figure 1. Seed Furrow and Planting Depth



Wrap Up

Precision Planting is excited to share our 2021 PTI research farm results and findings. We hope they provide useful insights that help drive thoughtful consideration around future crop management. The PTI Farm is working diligently to continue with long-term studies that provide multi-year data analysis for decision-making purposes. We will continue to work with our Precision Planting Premier Dealers to identify opportunities to find new research objectives, driving innovation and development of new solutions in the field. Precision Planting continues to find new ways to provide commitment to the development of innovations and insights that allow for the highest yield and ROI opportunities for your farm and family.

One of our goals at the PTI Farm is to continue to bring new, fresh, and unique ideas, so that when growers visit the farm they see and experience new technology. “Challenging the Status Quo” is an important concept to us and we always want to offer the opportunity for growers to experience, compare, and challenge their traditional ways of farming to other means. We all know that change is inevitable, but knowing what and when to change is critical to a business. At the PTI farm, we are excited about all of the agronomic trials slated for 2022 and you will not want to miss our upcoming field days. We look forward to seeing you throughout July-September at the Precision Planting Precision Technology Institute at Pontiac, IL.

Precision Planting would like to extend our sincere gratitude to the support and dedication of our Precision Planting Premier Dealers. Precision Planting Premier Dealers are world-class certified precision agriculture experts, with rigorous training and knowledge of the industry and issues facing farmers today. Our Premier Dealers are experienced professionals helping you know more, and ultimately creating more yield and profitability.

The ability to provide unbiased and objective insights into the agronomic research is important to us and we appreciate all Premier Dealers who scheduled and invited growers to the farm in 2021. If you are interested in visiting the PTI Farm in 2022, please contact a Precision Planting Premier Dealer to schedule your visit to the PTI Farm. For your convenience, click here to use our Dealer Locator to find the Precision Planting Premier Dealer nearest you.

http://www.precisionplanting.com/#dealer_locator/



Premier Dealer

PRECISION TECHNOLOGY INSTITUTE

All the research summarized here, was conducted as part of multiple research plots, by a team of experienced staff at the Precision Technology Institute research farm in Pontiac, Illinois. PTI is committed to challenging the status quo, to give growers agronomic insights and the tools that can help provide improved yield and economic bottom line on your own farm.

One of the questions that you may be asking after reviewing the extensive data and results from our 2021 research plots, is why? Why implement over 100 research plots, over 400 acres, with daily on-farm visits and agronomic discussions, through this time of uncertainty and so many new unknowns. The answer is what it has always been; we must continue to challenge the status quo. We must find better, smarter, and higher return on investment solutions for the growers and their farms. Precision Planting created the Precision Technology Institute in Pontiac, Illinois to provide a place for growers to meet and learn, while providing results of research plots that illustrate the practical value of their products in real world situations. The research we are sharing is designed by Precision Planting to better understand what solutions, in combination with real-world scenarios can actually provide, both a yield and economic benefit. These are learnings that we will continue to develop, implement, study and share, to provide our growers with the tools to help improve their bottom line.

Precision Technology Institute feels the best way to serve this goal to growers is as simple as having conversations. As part of this vision of having an on-going dialogue with growers, there are many ways to become part of the learnings and findings throughout the year, including an exciting new opportunity to visit PTI's new state of the art facility.



Become an Insider

A simple way to stay informed, as well as up to date on the research we are collecting here at the PTI Farm is to become an Insider. Subscribe to the InsidePTI weekly videos at insidepti.com for all your agronomic needs.



Come Visit us at the New Home of PTI

While a lot of research was happening over the year, PTI also has been breaking ground and completing the vision of a showplace for Precision Planting and growers to meet to continue conversations. In the late fall of 2020, we built a new home and enjoyed showing it to thousands of visitors as they came to our field days during the summer. We look forward to sharing this beautiful complex with more growers in the future and are excited to use it as an avenue to have more amazing conversations and learning opportunities with growers through-out the years to come.



The Precision Technology Institute now includes a 80'x120' shop that will double as an exhibit hall, two classrooms, two conference rooms, and a dining hall. With the new features of this state of the art facility, conferences can be held both virtually and in-person throughout the Winter season, as well as have it be our homebase for the popular field days during the summer months.



Come Experience Field Days at PTI

So what can you expect when attending summer field days at PTI? Whether you are a frequent visitor or looking forward to your first visit, PTI field days are a high energy, information packed, learning experience. Here are some of the one of a kind experiences you can choose to take advantage of all provided by Precision Planting at the Precision Technology Institute.

- **The Driver's Seat**

In our 27-acre sandbox, you take the wheel. Here, we hand YOU the keys to different tractor/planter combinations and allow you to run the equipment in real time, learning more in depth about how each piece works and the technology behind it. Precision Planting Support Technicians will be co-piloting in the buddy seat at this time, to answer any questions that may come about throughout your experience.

- **Core Principles and Planting Fundamentals**

This hands-on demo is led by the Precision Planting Regional Managers walking the growers through the importance of planter maintenance and furrow creation. Growers can see in person correct and incorrect furrow creation from two different planter row units. During this time, growers can interactively measure and correct the furrow created throughout the different planting conditions.

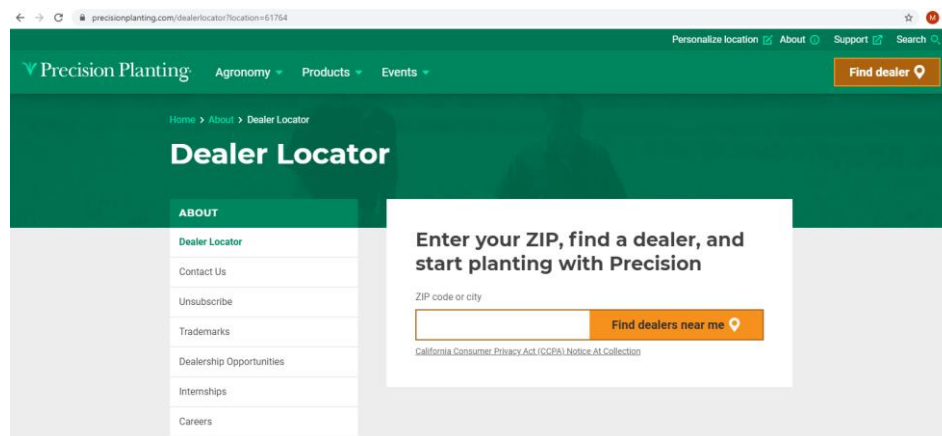
- **Agronomy Tour**

Lead Agronomist and PTI Farm Director, Jason Webster, takes you out into the field to dive deeper into the innovative agronomy and technology that we use each season throughout the different plots. You will learn about our new water recycling and tile drainage system, research tools, and technology/products available to implement on your farm.

- **Industry Days**

Each year, we invite industry partners to use PTI as an avenue to showcase their products and technology during the year. These customer focused field days are led by the industry partner's employees. If you are interested in hosting an industry day or becoming an industry partner of Precision Planting, contact Jason Webster at jason.webster@precisionplanting.com.

For more information regarding attendance of a PTI Field Day or Industry Day, reach out to your Precision Planting Premier Dealer or visit our website at precisionplanting.com/events to schedule a visit.



Acknowledgements and Legal Statement

vSet®, SmartFirmer®, Keeton®, CleanSweep®, SpeedTube®, DeltaForce®, vDrive®, FurrowJet®, Conceal®, mSet®, 20|20®, SmartDepth®, FurrowForce®, Reveal™, and WaveVFision® are all Trademarks of Precision Planting, LLC. ImPulse®, Triple Option®, K-Fuse®, Finishline®, Start2Finish®, bio-K®, Throwback®, First Down™, FaceOff®, Humi-Flex®, SideSwipe®, K-Flex® Max, Humi-Flex® FA, K-Fuel®, Balance®, Aqua Tech®, Nachurs® 10% Boron and Nachurs® 10% Molybdenum are manufactured and distributed by Nachurs Alpine Solutions. Charge12%™, Harvest Plus™, Fortified Stimulant Yield Enhancer®, Sugar Mover® Premier, Harvest More® Urea Mate, Bio-Forge® Advanced, and X-Cyte™ are all products of Stoller®USA. Pro-Germinator®, AccesS®, FertiRain, Sure-K®, Spring-uP, Micro 500™, eNhanse™ are all products of AgroLiquid LLC. BioMarc, Nitro “K”, NutriStart™ Boost and QuickGrow™ LTE are all products of Marco N.P.K. Inc. QLF® 7-21-3 MKP, Boost and Amino-15 are all products of QLF. The Andersons®, Season Pass®, RGS®, Biopass™ and Microcarb® are all products of The Andersons, Inc. Nano CS™ is a Trademark of Aqua Yield®. NutriCharge® is a Registered Trademark of AGROTECH. Sandy Cal, Grain Gain, Nutri-Shield, Power Pro II, Elevation and Aragonite are products of Ocean Blue Ag. ProveN40® is a Registered Trademark of Pivot Bio. NETAFIM™ Flexnet is a Trademark of Netafim LLC. NutriDrip System by Kurt Grimm. Sunflower®, Fendt®, and Momentum® are Trademarks of AGCO. Quasar™ is a Trademark of Capello Inc. KUHN Krause Gladiator® is a Registered Trademark of KUHN North America Inc. Montag® is a Registered Trademark of Montag Mfg. ADI™ Trademark of Ag Drainage Inc. John Deere® and John Deere 1770 Planter are Registered Trademarks of Deere & Company. Rantizo® is a Registered Trademark of Rantizo®. Hagie™ is a Trademark of Hagie Manufacturing Company LLC. NutriMax® Single Coulter, NutriMax® Double Coulter, NutriMax® Dual Delivery System, Brent® V1000 Auger Cart, NutriMax® 1400 Side-Dress Applicator are Registered Trademarks of Unverferth Manufacturing. Nitrogen Sealing Systems and N-Place™ are products of Nitrogen Sealing Systems. RISER® and Acetate® Technology are Registered Trademarks of Loveland. Veltyma™ and Revytek™ are Trademarks of BASF. Source™ is a Trademark of Sound™ Agriculture. Force®6.5G, Marvis® Neo and Triva Pro® are all Registered Trademarks of Syngenta Corp. SO4™ and 98G™ are Trademarks of Calcium Products. Capture® LFR®, Ethos® XB, Xyway™ and Top Guard® are all products of FMC Agricultural Solutions. Brandt® Auger Cart 820XT and Brant 51' Land Roller are all products of Brandt®. Case IH® Early Riser® 2150 are Registered Trademarks of CNH Industrial America LLC. Harvest™ International Ultra™ Series 40 20" planter is a Trademark of Harvest International. Finish Line™ Sweep is a Trademark of Finish Line™. STP, STV, and STPS manufactured and distributed by Prescription Tillage Technology L.L.C. SCIO™ is a Trademark of Consumer Physics. DICKY-john Mini Gac®plus is a Registered Trademark of Churchill Industries., Pioneer® is a Trademark of DowDuPont Corp. AgriGold® is a Registered Trademark of AgReliant Genetics, LLC, Dekalb® seed corn and Asgrow®, are Registered Trademarks of Bayer Corp, Golden Harvest® is a Registered Trademark of Syngenta Corp., Integra® is a Registered Trademark of Wilbur-Ellis., Stone Seed™ is a Trademark of Bayer.

The University of Illinois Machinery Cost Estimates provided by The University of Illinois Farm Business
The Iowa State University Tillage Rate provided by the Iowa State University Extension and Outreach